

The Wireless World

4^D

THE PRACTICAL RADIO JOURNAL

with Complete Foreign Programmes

Friday, July 6th, 1934.

**HIGH TENSION
FOR
NEXT TO
NOTHING**

Ask your dealer for BURTON All-Mains Units, or write for List to the makers—
C. F. & H. BURTON,
Progress Works,
WALSALL.

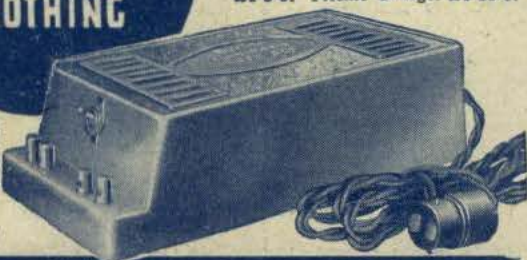

Why spend money on H.T. Batteries when you can run your set through a BURTON ALL-MAINS Unit with practically no increase in your Electric Supply account. No mains 'Hum' and your set permanently at peak of perfection. A.C. Models from £2-12-6. D.C. Models from £1-8-6. Trickle Charger £1-18-0.

BURTON ALL-MAINS UNITS

TELSEN D.R. TRANSFORMER

—the L.F. Transformer with a STRAIGHT LINE

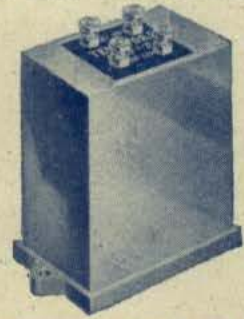

CHARACTERISTIC which gives UNIFORM AMPLIFICATION over the entire range of audio-frequencies. The spaced layer windings are impregnated with a non-hygroscopic material of very low specific inductive capacity which absolutely eliminates all possibility of shorted turns or breakdowns due to large magnetic surges

D.R.3 (ratio 3-1) **8'6**
D.R.5 (ratio 5-1)

Announcement of the Telsen Electric Co., Ltd., Aston, Birmingham.
TELSEN FOR EVERYTHING IN RADIO

EVERY TEST A.C. AND D.C.

CURRENT • VOLTAGE • RESISTANCE

WITH ONE INSTRUMENT
STILL GREATER ACCURACY AND USEFULNESS

The unrivalled testing facilities of this famous instrument have been still further extended by the addition of two further ranges of A.C. voltage readings for checking mains voltages with absolute accuracy on full scale deflection. The Universal Avometer retains its leadership as the world's most widely used and most accurate combination measuring instrument.

Fully descriptive pamphlet post free.
Automatic Coil Winder & Electrical Equipment Co. Ltd., Winder House, Douglas St., London, S.W.1
Telephone: Victoria 3404/7.



THE 36 RANGE UNIVERSAL AVOMETER

BRITISH MADE
12 Gns.
Deferred Terms if desired.
13-range D.C. Avometer 8 Gns.

AS TRUE AS THE STARS

No. 12 63/-
Other models from 25/-
For A.C. Mains only, 200/250 volts, 50 cycles, time controlled frequency. Obtainable from Electrical and Radio Dealers and high-class Jewellers.

Write for leaflet C7/N
FERRANTI LTD., HOLLINWOOD, LANCs.

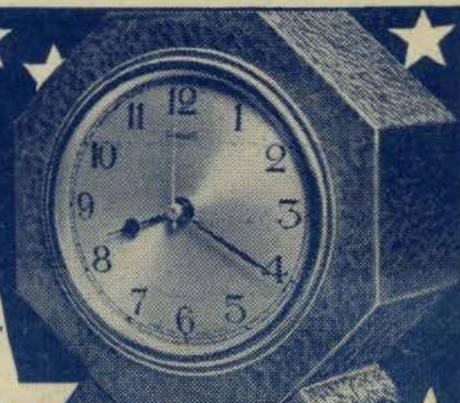

FERRANTI ELECTRIC CLOCKS

439810
 Postwar
 Southampton
 Haunts

Dear Sirs
 Received the
 Anti-Interference Unit safe
 and I must tell you
 it is the thing I have been
 hunting for ever since I
 first had my all-mains
 set. The interference was
 awful in our district,
 but thanks to your Unit
 it is a treat to listen to the
 programmes now. Thank
 you for prompt delivery

**"A TREAT
 TO LISTEN
 NOW"**

with the

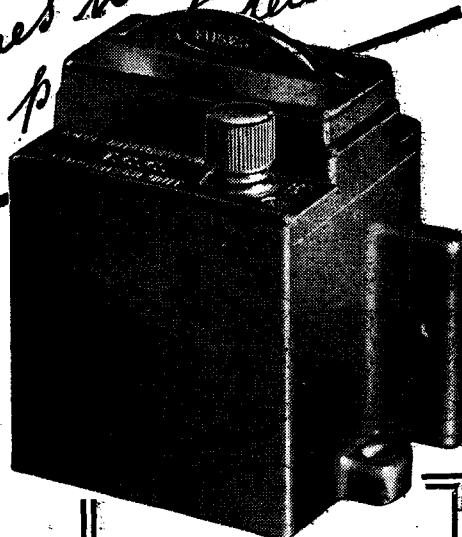

PRICE
 Complete
 with
 Instructions **10/6**

A nightmare of "crackles" and "buzzes" has ended for this Southampton Listener who fitted a T.C.C. Anti-Interference Unit. Neon signs, motors and generators do not exist for him as far as his radio is concerned. Don't let your listening be marred by such "man-made static"—this T.C.C. Unit will cut it out. Ask your Dealer to-day.

The Telegraph Condenser Co., Ltd., Wales Farm Road, N. Acton, W.3.

T.C.C.
CONDENSER
 ANTI-INTERFERENCE UNIT

**RADIO
 DATA
 CHARTS**

A
 SERIES OF ABACS

providing most of the essential
 Data required in Receiver Design

By
R. T. BEATTY, M.A., B.E., D.Sc.

Reprinted from
 "The Wireless World"
 1930.

"Radio Data Charts" provide designers of wireless apparatus with a ready and convenient means of solving problems without having recourse to complicated formulæ and mathematics.

By the use of the charts it is possible to tackle all the more familiar problems in radio receiver design, such as, for example, finding the relationship between inductance capacity and frequency, and working out the design of high frequency transformers. All keen amateurs will appreciate this helpful book.

(39 CHARTS and more than
 50 Diagrams)

Price 4/6 net
 By post 4/10

Published from the Offices of
 "THE WIRELESS WORLD"

From all leading booksellers or direct
 from the Publishers

ILIFFE & SONS LTD.
 Dorset House,
 Stamford St., London, S.E.1

W.W.91

The Wireless World

THE PRACTICAL RADIO JOURNAL
24th Year of Publication

No. 775.

FRIDAY, JULY 6TH, 1934.

VOL. XXXV. No. 1.

Proprietors: ILIFFE & SONS LTD.

Editor:
HUGH S. POCKOCK.

Editorial,
Advertising and Publishing Offices:
DORSET HOUSE, STAMFORD STREET,
LONDON, S.E.1.

Telephone: Hop 3333 (50 lines).
Telegrams: "Ethaworld, Watloo, London."

COVENTRY: Hertford Street.
Telegrams: "Cyclist, Coventry." Telephone: 5210 Coventry.

BIRMINGHAM:
Guildhall Buildings, Navigation Street, 2.
Telegrams: "Autopress, Birmingham." Telephone: 2970 Midland (3 lines).

MANCHESTER: 260, Deansgate, 3.
Telegrams: "Iliffe, Manchester." Telephone: Blackfriars 4412 (4 lines).

GLASGOW: 26B, Renfield Street, C.2.
Telegrams: "Iliffe, Glasgow." Telephone: Central 4857.

PUBLISHED WEEKLY. ENTERED AS SECOND CLASS MATTER AT NEW YORK, N.Y.

Subscription Rates:
Home, £1 1s. 8d.; Canada, £1 1s. 8d.; other countries, £1 3s. 10d. per annum.

As many of the circuits and apparatus described in these pages are covered by patents, readers are advised, before making use of them, to satisfy themselves that they would not be infringing patents.

CONTENTS

	Page
Editorial Comment	1
Broadcast Distribution	2
Universal Single-Span Receiver ..	6
News of the Week	10
FOREIGN PROGRAMME SUPPLEMENT, pp. I—XXIV	
What Wattage?	11
Broadcast Brevities	12
Ferranti Lancastria Superhet ..	13
Letters to the Editor	14
Practical Hints and Tips	15
Unbiased	16

EDITORIAL COMMENT

Friendly Relations

The B.B.C. and its "Subscribers"

IT is a pity that the B.B.C. does not appear up to the present to have been able to inspire that particular form of affection—warm or merely tolerant—that we as a nation are so ready to bestow on many of our public institutions with which it is more or less closely comparable. It enjoys general confidence and respect, but certainly nothing approaching affection or feelings of loyalty. The attitude of a large section of its patrons seems to be one of mere toleration, or, more often, of mild antagonism.

Harmonious relations, or even rather closer ties, between the listening public and those responsible for supplying its wireless programmes are essential to the full development of the enormous potentialities of broadcasting. There are hardly any signs that such a state of affairs actually exists; there are, for instance, no records of bequests to the B.B.C. "for the improvement of broadcasting and as a token of appreciation." Even the Income Tax authorities, who in the nature of things cannot hope for a large share of the public affection, obtain a larger revenue from conscience-stricken tax defaulters than does the B.B.C. (through the Post Office) from repentant pirates.

Superiority Complex?

For this state of affairs, the "superior" attitude of the B.B.C. is usually held to be mainly responsible. It is also a fact that we are not accustomed to be admonished by those to whom we stand in the relationship of customers, clients or patrons, and so it is, perhaps, regrettable that aims which have been the subject of per-

sistent broadcast propaganda have been put forward in such a way that listeners as a body are severely taken to task, the just being lumped together with the unjust. It is not suggested that the views or aims propagated are anything but laudable in themselves, but if we are to be told to amend our ways it might make for more harmonious relations if exhortations to do so were to come from associations formed to combat the abuses, and were not put forward as the views of the B.B.C. Resentment or irritation would then be directed against the speaker or the association that he represents, and not against the broadcasting organisation.

Veiled Propaganda

The vital question of whether or not the B.B.C. should engage in propaganda cannot be discussed here, but the Corporation's popularity would certainly be enhanced if all propaganda were clearly labelled as such.

As a start towards promoting a better state of affairs, it is suggested that a more helpful outlook among B.B.C. officials might be inculcated by the adoption of the term "subscriber" instead of "listener." They would then have a constant reminder that they are public servants, depending on the favours of those who pay for the broadcasting service.

Matters would not be improved by a less dignified method of address on the part of the announcers; few of us would wish them to adopt the informal air of patently false *bonhomie* which passes muster in certain other countries. The trouble lies deeper than that, and, as the B.B.C. has an unequalled opportunity to sway public opinion by direct contact, the remedy should not be hard to find and to apply.

Broadcast Distribution

By NOEL ASHBRIDGE, B.Sc.

(Chief Engineer, British Broadcasting Corporation)

A PERFECT service to every potential listener in the country is still an impossibility, and in this article the Chief Engineer of the B.B.C. states why. Describing step by step the growth of the British broadcasting system, Mr. Ashbridge explains the decisions which have led to the construction of new stations and, in certain circumstances, the scrapping of old ones

WHEN the British Broadcasting Company assumed responsibility for the service in November, 1922, there were already three transmitting stations in existence, namely, London, which was erected by the Marconi Company; Birmingham, erected by the Western Electric Company, now known as Standard Telephones & Cables, Limited; and Manchester, erected by the Metropolitan-Vickers Electrical Company, Limited. Very shortly afterwards, in December of the same year, Newcastle was opened by



A general view of the B.B.C.'s new high-power station at Wychbold, near Droitwich, to be opened early in September.

the B.B.C., followed during the first ten months of 1923 by Cardiff, Glasgow, Aberdeen and Bournemouth. These formed the original eight stations which, on taking over the service, the B.B.C. undertook to erect and operate. Later a ninth station was added, namely, Belfast. The power in each case was a nominal $1\frac{1}{2}$ kW, which means that the aerial power was about 1 kW.

The policy in those days was to begin by serving the most densely populated areas in each part of the country, in order to judge the popularity of broadcasting, and to test requirements for the future. Reference to the map reproduced will show how the population is distributed.

It was considered at first that these stations would have a range of about

seventy miles, this estimate being based on the range which would have been obtained for ordinary telephony with a similar transmitter. It soon became apparent, however, that for broadcasting a more constant signal with greater freedom from interference was necessary than for straightforward point-to-point communication. Although the standard expected in those days was obviously very much below present day levels, it was found that about thirty miles was the limit for a station of this kind over average country. This applied to a good valve receiver; the range on a crystal set was somewhere in the neighbourhood of ten miles. Of course, much greater ranges were obtained at night, and in special circumstances, as is always the case. It will be remembered that at first reception was almost entirely on headphones, there being very few loud speakers in existence.

Another fact which is now well known soon began to make itself felt, namely, that the average percentage of modulation for good quality had to be very much lower for a broadcast transmission than for other purposes, and as this was given effect the reliable range for these transmitters was again reduced.

An Expensive Arrangement

During the first two years there was comparatively little trouble about wavelengths, because very few stations were working on the continent of Europe, and it was possible to work all these early transmitters on wavelengths above 300 metres, which, of course, greatly helped the problem of coverage.

Towards the end of the first year, while it became clear that broadcasting was becoming popular, it also became evident that if it was to expand it was essential to increase the potential number of licences. So far each station produced its own programme, which meant that some

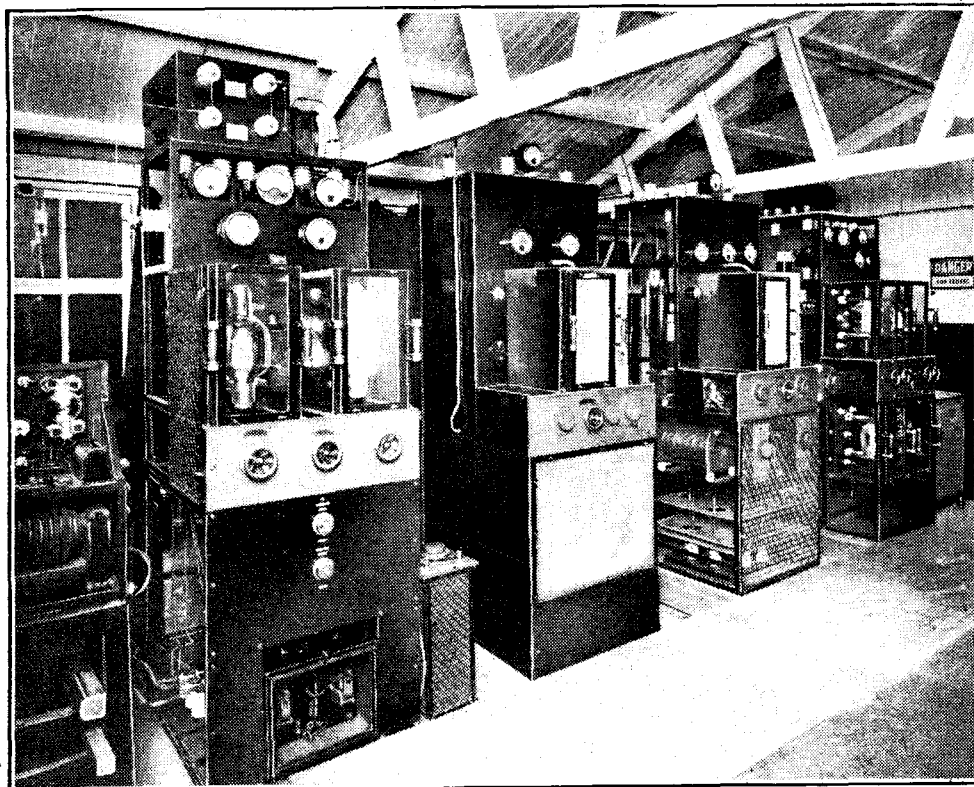

The $1\frac{1}{2}$ -kW. set at Bournemouth, a typical B.B.C. station of 1923.

The Story of Twelve Years' Development

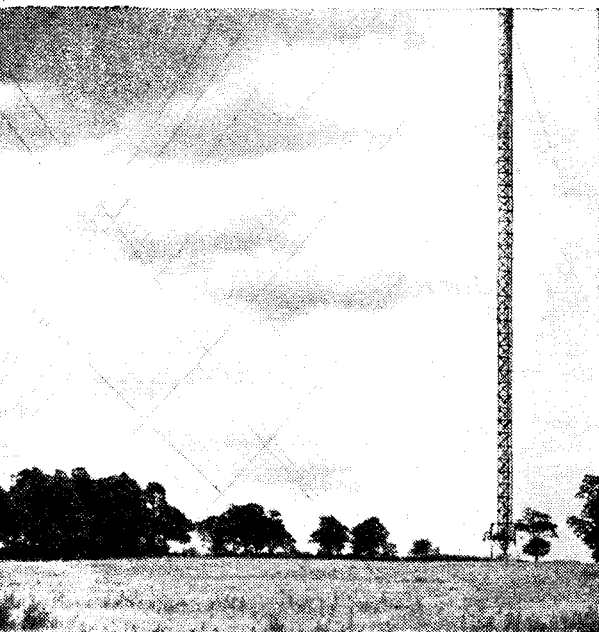

eight complete programmes had to be produced each night, a very expensive arrangement, particularly in relation to the finances of those days. Fortunately, however, artists' fees were very low, and in some cases nil. It became necessary, therefore, to devise means whereby more listeners could be obtained without increasing the number of separate programmes. This gave rise to the relay station development which, without any doubt, very much assisted to establish the B.B.C. firmly on its feet financially. Sheffield was the first relay station opened, in November, 1923, then Plymouth in March, 1924, followed at approximately monthly intervals by Edinburgh, Liverpool, Leeds, Bradford, Nottingham, Stoke, Dundee and Swansea. These stations worked with a power in the aerial of about 120 watts, and their range was somewhere about ten miles.

Long Waves to the Rescue

Soon after it opened, the Edinburgh station was found to be incapable of serving the hilly broken country in that neighbourhood, and eventually it became necessary to use rather more than double the power. At about the same time the London transmitter was increased to 2 kW. (aerial power) and erected on the roof of the Selfridge building. Neither of these two changes, however, had any real effect on the development of the distribution as a whole.

The relay stations provided partly their own programme and partly an S.B. programme, but their programme costs were very much lower than in the case of the main stations. At the beginning of 1924, therefore, the position was that most of the larger cities were well served, but other cities and towns and the country districts were practically not served at all, although there were numbers of enthusiastic listeners making the best of about $\frac{1}{2}$ millivolt per metre or less.

It was soon realised that it would be impossible to serve the whole of England,

Scotland, Wales and Northern Ireland by having a large number of low-power stations. At the same time it was also realised that by raising the power of a station on a so-called medium wavelength (that is to say, a wavelength below 600 metres) one could not push up the radius of action to much more than about seventy or eighty miles, on account of fading, which, theoretically at any rate, is independent of the power of the station. On the other hand, it was suggested that if a high power station could be operated on a long wavelength, that is to say, a wavelength above 1,200 metres, so as to reduce attenuation, then by using fairly high power a very large area could be served. There was, of course, a great deal of discussion before this idea was put into practice. Difficulties were raised in connection with sets and coil changing, as

well as possible interference to other services, and doubt was expressed in some quarters as to whether the effect of the long wavelength would be to reduce attenuation to the extent predicted. In order to settle the matter once and for all an experimental "5XX" was erected in the Marconi Works at Chelmsford in July, 1924. It was an immediate success, and gave excellent coverage. However, Chelmsford obviously was not the right place for a permanent station, and eventually, in November, 1924, approval was obtained for the building of a permanent long-wave station at Daventry, with a power of 25 kW. The station was opened on July 27th, 1925, and there is no doubt that this was one of the most important events in British broadcasting, because from that date broadcasting became a national activity.

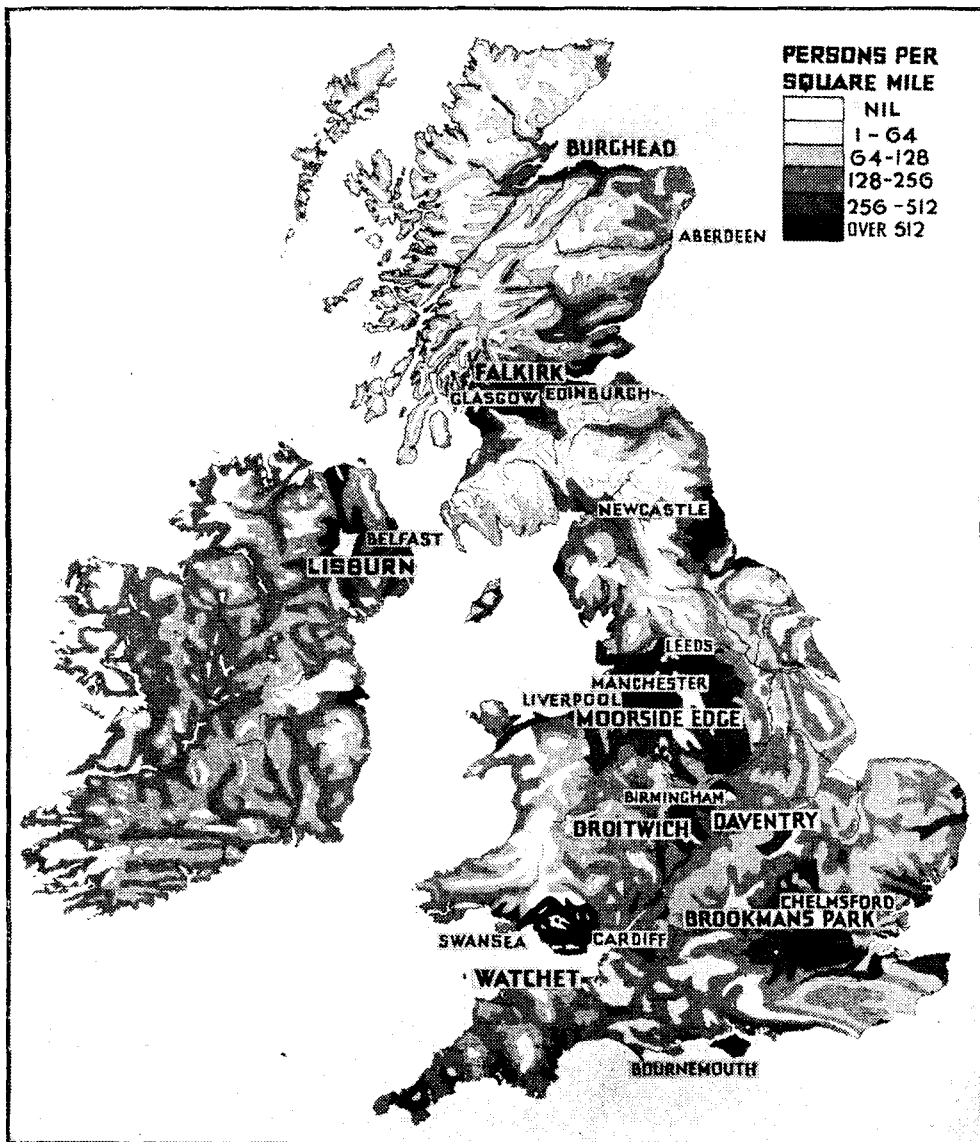

The distribution of population in the British Isles, as shown in this map, has largely influenced the development of the broadcasting system.

Broadcast Distribution—

It should be mentioned that the old experimental 5XX at Chelmsford transmitted alternative programmes three days a week, starting in December, 1924, so that really alternative programmes started from that time. This idea of supplying two programmes, one being of a national or universal character, and the other of a more local or regional character, gained considerable popularity, and out of it was born the Regional Scheme in its original form, with twin high-power medium - wave stations in five main centres of population. However, before going on to consider this development, something must be said about the wavelength difficulties which in recent years have very greatly affected the development of broadcasting and the method of distributing programmes.

At the end of 1924 the B.B.C. was using some twenty different wavelengths, all of which, as previously stated, were above 300 metres. At about this time stations began to spring up all over the Continent, and one of the most unfortunate facts which exist in connection with the technical side of broadcasting was realised for the first time. This was that a station of 1 kW. 1,000 miles away could interfere with the broadcast from a station of

similar power about twenty miles away, during the hours of darkness. In those days this was only accepted by broadcasters in Europe after a good deal of talk, but it was obviously impossible to disguise

wise, which were drawn up in an effort to reduce mutual interference. It will suffice for our present purpose to state that it became necessary to reduce the number of wavelengths used by the B.B.C., and the relays had to give up their "exclusive" waves. As a result, for a time, they worked on international common waves, and, later, they were roughly synchronised together on one wavelength. Neither of these expedients was very successful, and ultimately they were accurately synchronised by means of tuning-fork apparatus, which in those days kept the transmitter frequency constant to within about 30 cycles. In 1929 the international agreement known as the Prague Plan, which was one of the landmarks in broadcast

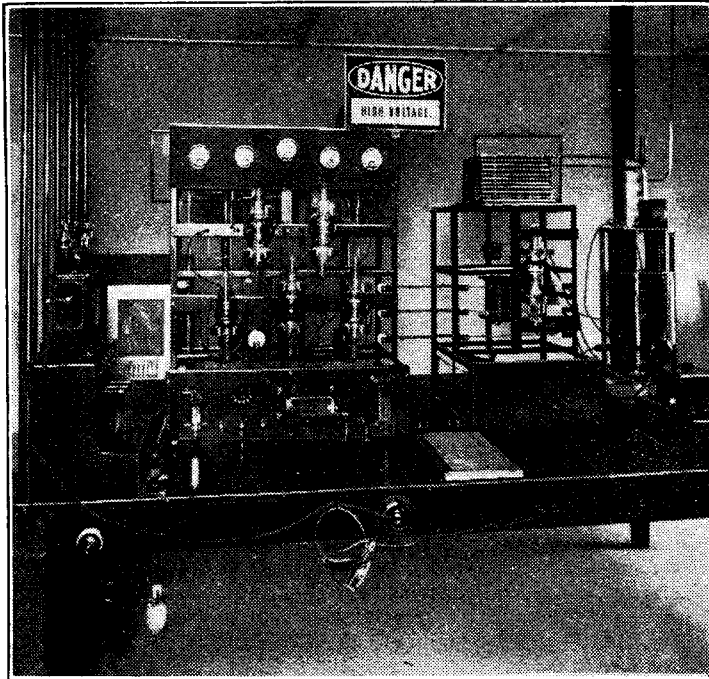

Dundee, a typical 120-watt relay station opened in 1924.

the fact for long, because with the increasing number of stations working without any kind of international wavelength plan, practical demonstrations took place every night. It is not proposed to go into the history of the formation of the International Broadcasting Union, and the various wave plans, both successful and other-

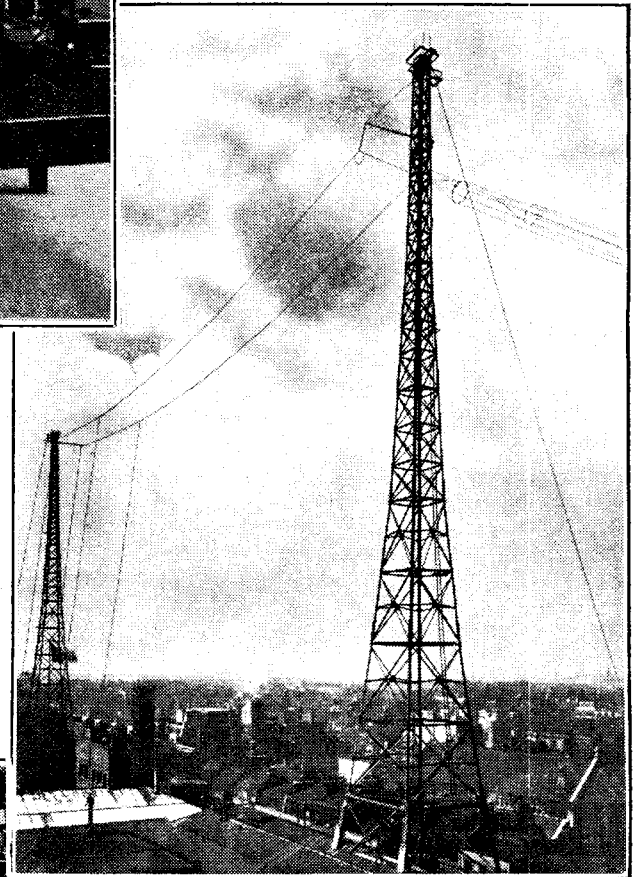

"2LO." The London masts on the roof of the Selfridge building in 1925. The transmitter had an aerial power of 2 kW.

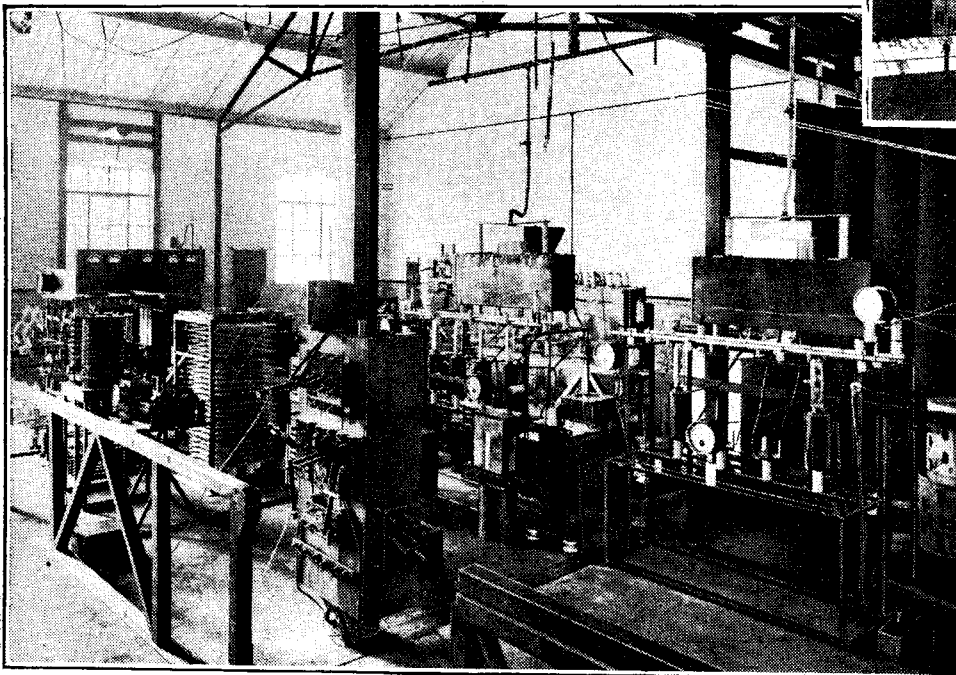

5XX, the experimental long-wave station in the Marconi Works at Chelmsford. The successful tests with this transmitter led to the erection of the permanent long-wave station at Daventry.

development, allocated one long wavelength and nine medium wavelengths to this country, some of the latter being below 300 metres. Thus, the twin transmitter Regional Scheme, when eventually it came to be applied, had to be developed on this basis.

From 1924 onwards there was a great deal of agitation on the part of some listeners to have a local programme, with a counter agitation on the part of other listeners in the same district to have programmes of a type which could better be produced in London. It was this fact, coupled with the widely differing tastes of the public in general, that made it highly desirable to develop the double programme idea. However, the capability of the average receiver was very much below that of the present-day set, particularly in

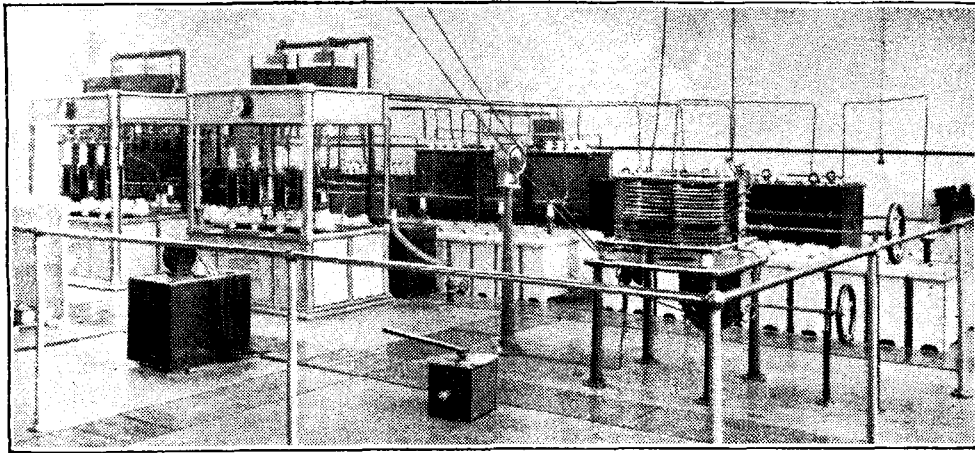

The interior of Daventry 5XX, the long-wave station opened on July 27th, 1925, and still in service.

connection with selectivity. Many receivers were unable to receive a field strength of, say, 5 millivolts per metre clear of interference in the presence of the field of another station giving, say, 30-40 millivolts per metre, even when there was a separation between the two channels of 150 to 200 kc/s. It was for this reason that the transmitters sending out each programme were located at the same place, because, obviously, it is easier for a receiver with poor selectivity to distinguish between two signals when they are of sensibly equal strength.

The function of 5XX in this plan was to fill in all those areas which were not covered by the regional stations, it being admitted that a second programme could not be given to the whole country, although on the standards of service then existing, it was considered that a single programme was being given to practically the whole country.

Before this scheme was finally adopted it was decided to erect a second transmitter working on a medium wave at Daventry, alongside 5XX, with the idea first of all of developing the best possible circuit for a high-power medium-wave transmitter, and, secondly, of testing the effect of two transmitters radiating from the same station. The construction of this transmitter was begun in the summer of 1926. (To be concluded.)

The Short-Wave World

Is it "Moonshine"? : Some Surprising Americans : Daventry Championed

THE effect of the moon upon short-wave radio has been a "silly season" topic ever since short waves were first discovered. The writer is assured, however, by a keen receiving member of the R.S.G.B. that the effect is perfectly reliable and well-defined.

This gentleman has been keeping really comprehensive receiving logs since 1926, and some of his observations certainly lend probability to his statement that reception on and below about 25 metres nearly always "peaks" at the time of the full moon.

The batch of good conditions that were mentioned recently in these notes certainly occurred at about the time of a full moon,

and within a week they had faded out again. At the time of writing they are improving once more.

There must be many readers who have kept some sort of receiving log over a long period. Any observations of regular cycles of conditions (apart, of course, from the fifteen-monthly variant of the sunspot cycle) should provide some interesting data.

Just at present conditions for the reception of North American broadcasts are somewhat better than usual. A peculiar feature of the past spring has been the way in which some of the Central and South Americans (notably the Colombians) have overshadowed the better-known North American stations. This particular phase of conditions seems, at last, to have come to an end.

Any short-wave sceptics (if such people exist in these enlightened days) should be invited to hear W8XAL (49.5 metres) or W3XL (46.7 metres) late in the evening—preferably on a night when atmospherics are not too heavy and one can be liberal with the volume control.

Another surprisingly good and consistent transmission, of more interest to those who do not care for late sessions, is that of W8XK on 25.27 metres. Veteran readers who remember the old KDKA station when it first used to make itself heard in this country will agree with a reader's statement that "W8XK is keeping up the old KDKA tradition."

One is used to receiving American stations with comparative ease, but now and then a transmission is received with such strength, constancy and perfection of reproduction that one derives a completely new thrill from short-wave reception. Such a transmission has been coming over from W8XK day after day.

In this country "DX," to the uninitiated, means "U.S.A." Certainly most of the dis-

tant stations available to a not-too-sensitive receiver are the high-powered Americans. It is, therefore, rather refreshing to read a letter from a short-wave enthusiast in South Africa.

This particular gentleman's one ambition is to be able to show his friends that Daventry has "beaten" Radio Coloniale and Zeesen, from the point of view of signal strength. He remarks that Daventry's transmissions are almost beyond criticism (except for the 49.6-metre wave, which is nearly always swamped by static), but that usually Zeesen and Radio Coloniale, and sometimes Rome, are better still.

Patriotism, meanwhile, lies dormant, awaiting its opportunity to point out that British is best. Seriously, however, the explanation probably lies in some little freak of location. Several South African readers have reported the Empire station as the best of all the Europeans.

Other little excitements that they have in South Africa include groping for a West Coast American station, which is a real rarity. Sydney, too, is very exclusive. As a matter of fact, on the amateur bands there have been remarkably few contacts between South Africa and Australia in the whole history of radio. MEGACYCLE.

BOOK REVIEW

Theory of Radio Communication: Post Office Engineering Department, Technical Instructions. Pp. 153, with 173 diagrams. Published by H.M. Stationery Office, London. Price 7s.

This book is hardly the complete text book that its title would suggest, but is a collection of pamphlets (of varying size) prepared primarily in connection with workmen's correspondence classes in the P.O. Engineering Department. As a text book it would have been improved by more editorial linking matter, cross-references, and indexing; but as a compilation of material it is very full of information on general wireless practice, and particularly of Post Office practice. The sections on aerial and earth systems, valve transmitters, radio telephony and radio receivers are particularly directed towards exposition of Post Office practice, and give a more useful account of the arrangement of aerial arrays and commercial circuits than are to be found in other text books. This somewhat specialised exposition does not, however, detract from the generally useful character of the book or from the considerable amount of valuable information that it contains.

ADAPTABLE CAR RADIO

IT was recently suggested editorially in this journal that the usefulness of a car radio set might be increased if it were possible to

detach it easily from the car and to operate it in other positions. A receiver planned on these lines has now actually been produced by Baker's Selhurst Radio, Ltd., of 75-77, Sussex Road, Croydon, Surrey. The car battery supplies current for filaments and loud speaker field. Although not primarily intended for operation "under way," the set can be so used.

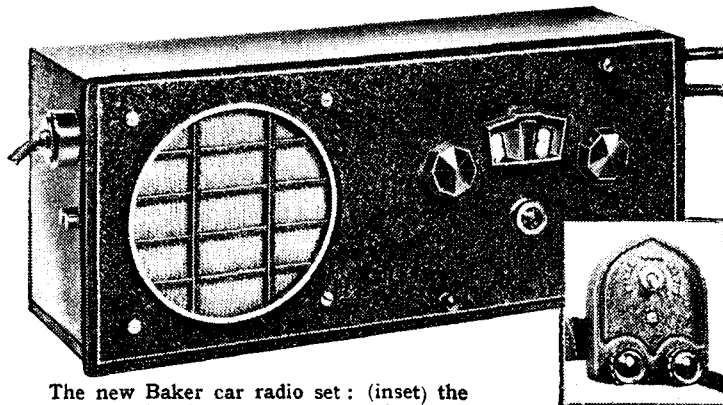

The new Baker car radio set: (inset) the optional remote-control unit.

The Universal Single-Span Receiver

A Set for Operation from Either A.C. or D.C. Mains

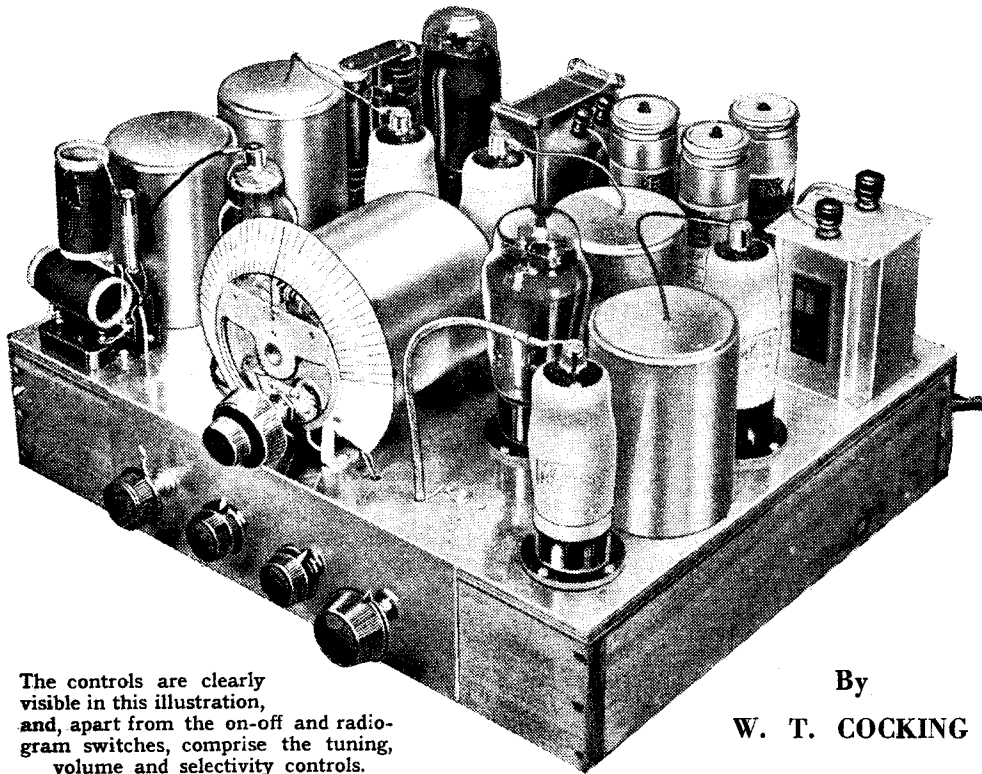

The controls are clearly visible in this illustration, and, apart from the on-off and radio-gram switches, comprise the tuning, volume and selectivity controls.

By
W. T. COCKING

Universal Single-Span Receiver, and the changes which have been made are only those dictated by the different method of supply and the different valves employed. The essential features of single-span tuning—the absence of ganging, and coil switching, the full waveband coverage and freedom from second channel interference—are fully retained.

The complete circuit diagram appears in Fig. 1, and it will be seen that the valves are arranged as a heptode frequency-changer, followed by a triode buffer valve, two I.F. stages embodying H.F. pentodes and a duo-diode-triode which provides detection, delayed A.V.C., and first stage L.F. amplification. The output valve is a pentode, and a half-wave rectifier is provided for A.C. working. The valves are all rated to consume the same heater current of 0.2 ampere, and the heaters are connected in series. The heptode is the Micromesh 15.D.1, and its heater is rated at 13 volts; the other valves are Mazda and the HL.1320, the two VP.1321, and the

THE possessor of a direct-current lighting supply is often chary of investing in a mains-operated receiver lest it should be rendered useless by a change to alternating current. Most, if not all, D.C. supplies will eventually be changed to A.C., but in few cases can reliable information be obtained of the probable date of the change-over.

It is fortunate, therefore, that this state of affairs is no bar to the use of a mains-driven receiver, for it is readily possible to construct one which will operate with equal efficiency from either form of lighting supply. The "Universal" type of set is essentially similar to a D.C. mains receiver, and the valve heaters are all wired in series; a rectifier is included, however, so that a uni-directional H.T. supply may be obtained from A.C. mains.

The circuits of the receiver proper are essentially the same whatever method of power supply be adopted—the differences are of a minor order and due partly to the nature of the power supply, but more to the particular class of valve, the use of which is dictated by the method of feeding the set. In the case of an A.C. mains set, for instance, a wide range of valves is available and it is possible economically to employ a high H.T. voltage, so that a directly heated triode output valve becomes possible. With a battery supply, however, less efficient valves are available, and economy dictates that the anode current consumption be kept at a low figure; moreover, a quiescent type of output stage is now almost a necessity. The case of a D.C. mains receiver or the Universal type of set comes between the A.C. and battery classes. The valves available are as

efficient as those in the A.C. ranges, but the types are limited. In addition, the H.T. supply cannot exceed the mains voltage. No great limitation is placed on current, however, so that quiescent output stages are unnecessary, but the low voltage precludes the use of a triode output valve, and one is forced to employ a pentode.

The essential features of earlier single-span receivers have been retained in the

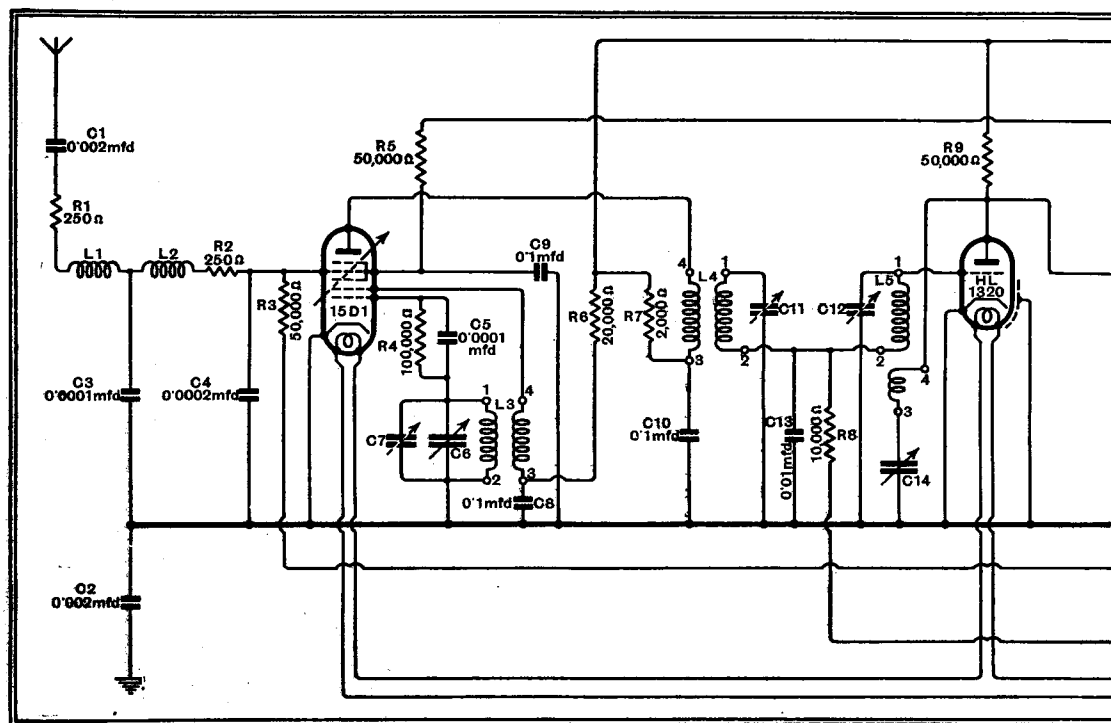

Fig. 1.—The complete circuit diagram of the new receiver shows that the essential features of the H.T. supply on A.C.

HL.DD.1320 are also rated at 13 volts. The Pen.3520, however, requires 35 volts and the U.4020 needs 40 volts.

The heaters, therefore, consume 140 volts at 0.2 ampere, so that on a 200 volts supply only 60 volts need be thrown away in a dropping resistance, for the 2 volts required by the dial lights can be ignored. The fixed portion of the resistance R21, therefore, is given a value of 300 ohms, and it dissipates only 12 watts. On 250 volts mains, however, a further 50 volts must be dropped; a portion of R21, having a resistance of 250 ohms, is included and provided with a tapping every 50 ohms for mains voltages between 200 volts and 250 volts. It will be seen, therefore, that R21 is actually a fixed resistance of 300 ohms in series with a tapped resistance of 250 ohms.

The aerial coupling circuit consists of the two coils L1 and L2, with the resistances R1 and R2 of 250 ohms each, the 0.0001 mfd. condenser C3 and the 0.0002 mfd. condenser C4. This filter passes frequencies between 150 kc/s and 1,500 kc/s, but greatly attenuates frequencies outside this range. Condensers C1 and C2 of 0.002 mfd. capacity are inserted in the aerial and earth leads in order to prevent any short-circuit between the mains and earth. It will be seen that no variable tuning is included in the aerial system, and that all frequencies within the receiving range are applied simultaneously to the tetrode control grid of the heptode valve.

A tuned circuit, however, is connected to the oscillator grid of this valve, and its tuning varied by the 0.00016 mfd. condenser C6 which forms the only tuning control. The frequency of the oscillations generated by the inner electrodes of

the heptode can be varied over a range slightly greater than 1,750 kc/s to 3,100 kc/s, so that the intermediate frequency of 1,600 kc/s can be produced from any desired station.

A transformer L4 of 1-1 ratio is connected in the tetrode anode circuit of the heptode and tuned to 1,600 kc/s. Coupled to this by a capacity coupling C13 is another tuned circuit L5, to which reaction

RECEIVERS for both A.C. mains and for battery operation embodying the single-span system of tuning have already been described in "The Wireless World," and in this article appear details of a model which functions equally well from either alternating or direct current. It will be remembered that the use of single-span tuning leads to the abolition of ganging and waveband switching, and renders second channel interference troubles non-existent. The present receiver, therefore, is of particular interest to those with D.C. mains.

can be applied from the triode buffer valve. This buffer valve is coupled to the first I.F. stage by a resistance-capacity coupling comprising the 50,000 ohms resistance R9, the 0.001 mfd. condenser C15, and the 100,000 ohms resistance R10. This particular arrangement is adopted in order that reaction may be applied to a circuit which is largely isolated from the others as far as stray couplings are concerned.

The L.F. Circuits

The first I.F. valve is coupled to the second by a 1-2 ratio transformer L6 with a secondary tuned to 1,600 kc/s, and the second stage is coupled to the detector by a transformer L7 of more complicated design. The tuned circuit is fed from a

primary, the ratio being 2-3, and a tertiary is included with a ratio of 3-2 from the tuned circuit. The detector diode is fed from this tertiary, and the usual filter comprising Chr and the two 0.0001 mfd. condensers C21 and C22 is included. The diode load resistance R12 is given a value of 100,000 ohms, and the L.F. potentials developed across it are applied to the triode grid through the 0.01 mfd. condenser C23 and the 250,000 ohms volume control potentiometer R13.

Resistance coupling is used between the triode and the output pentode, and de-coupling of the triode anode circuit is provided by the 10,000 ohms resistance R15 and the 8 mfd. electrolytic condenser C27. The output transformer primary is included directly in the pentode anode circuit, and is shunted by the 10,000 ohms resistance R23 in series with the 0.005 mfd. condenser C35 in order to maintain the correct load on the pentode and to prevent an excessive treble response.

The mains leads are taken first to the double-pole on-off switch S2, and then to a pair of fuses rated at one ampere. The current for the heater supply is then tapped off, and the remaining current passes through the half-wave rectifier. On a D.C. supply the rectifier acts as a simple resistance, but on A.C. it passes only alternate half-waves, and so gives a pulsating output. A 4 mfd. reservoir condenser C34 follows the rectifier and the current then passes through the first smoothing choke Ch3, where initial smoothing takes place in conjunction with the 8 mfd. electrolytic condenser C33. The anode of the output valve is fed from this point, but further smoothing is required for the screen of this valve and the early stages. This is provided by Ch2 and C28.

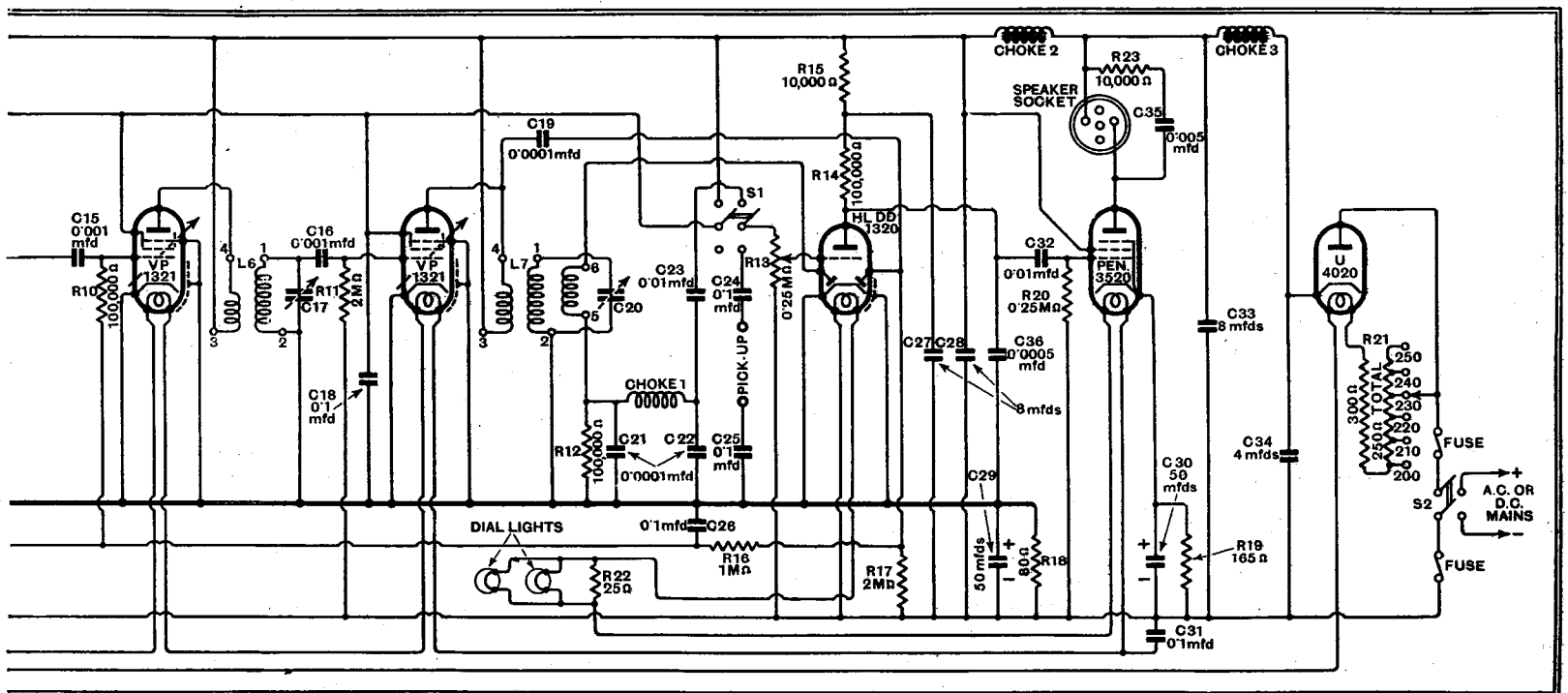

single-span tuning are retained. The valves all consume 0.2 ampere and their heaters are connected in series. The half-wave rectifier provides mains, and on a D.C. supply it protects the electrolytic condensers from damage.

The Universal Single-Span Receiver—

It will be noted that the smoothing condensers are all returned to negative H.T., which is not at the same potential as the earth line to which the cathodes of all the early valves are directly returned. Grid bias for the output valve is obtained by inserting a 165-ohms resistance R19, shunted by a 50-mfd. condenser C30 in its cathode lead—the lower end of this resistance and the grid leak R20 both being returned to negative H.T.

An 80-ohms resistance R18, shunted by a 50-mfd. condenser C29, is joined between the earth line and negative H.T., so that the latter point is about 2.5 volts negative with respect to the earth line. The grid return leads of all the early valves are returned, either directly or through A.V.C. resistances, to negative H.T., so that they all have the same initial bias of 2.5 volts.

The heptode and the first I.F. valve are both controlled for A.V.C. purposes, and the A.V.C. bias is obtained from the second diode in the duo-diode-triode. This diode is fed from

the last I.F. transformer primary through the condenser C19. Its load resistance R17 of 2 megohms is returned to negative H.T., so that a delay of 2.5 volts is obtained. When the signal input to the detector exceeds 2.5 volts, therefore, rectification

to negative H.T., the value of which depends upon the signal strength. This potential is applied as additional bias to the two controlled stages through the usual filter circuit R16 C26.

When the set is tuned to a certain signal the bias on the two controlled valves is thus the initial bias plus a figure which depends on the signal strength. When a stronger signal is tuned in the detector input and the A.V.C. bias both increase, so that the total bias on the controlled valves rises and the amplification of these stages consequently falls. The net result is that although the detector input rises with increased signal strength in the aerial, it rises less than it would do if all valves were operated with a fixed bias, and quite large changes in aerial input are possible with little or no change in the audible output. Most of the stronger stations, therefore, can be tuned in at about the same volume, and some of the effects of fading are avoided.

The valves selected for use in the I.F. stages are rated for operating with their screen grids at the same potential as their anodes, so that a screen-feed potentiometer becomes unnecessary. The heptode, however, requires a screen potential of only some 100 volts, and this is obtained by feeding it through the 50,000-ohms resistance R5. One pole of the radio-gramophone switch S1 is arranged to break the screen circuits on gramophone in order to prevent any possibility of radio signals breaking through. The other pole of this switch changes the connection of R13 from C23 to one of the pick-up terminals. It will be noted that 0.1-mfd. condensers C24 and C25 are inserted in the pick-up leads in order to isolate this component from the mains.

The Mains

This point may require a little explanation. In any D.C. mains or Universal receiver the circuits of the set are in direct connection with the supply mains, for it is not possible to employ a transformer as in a purely A.C. set. Now, one pole of the mains is almost invariably earthed at the supply station, so that one of the mains leads is some 200-250 volts above or below earth. In many cases the negative H.T. line of the receiver will be at about the same potential as earth, but in many others it will be 200-250 volts different.

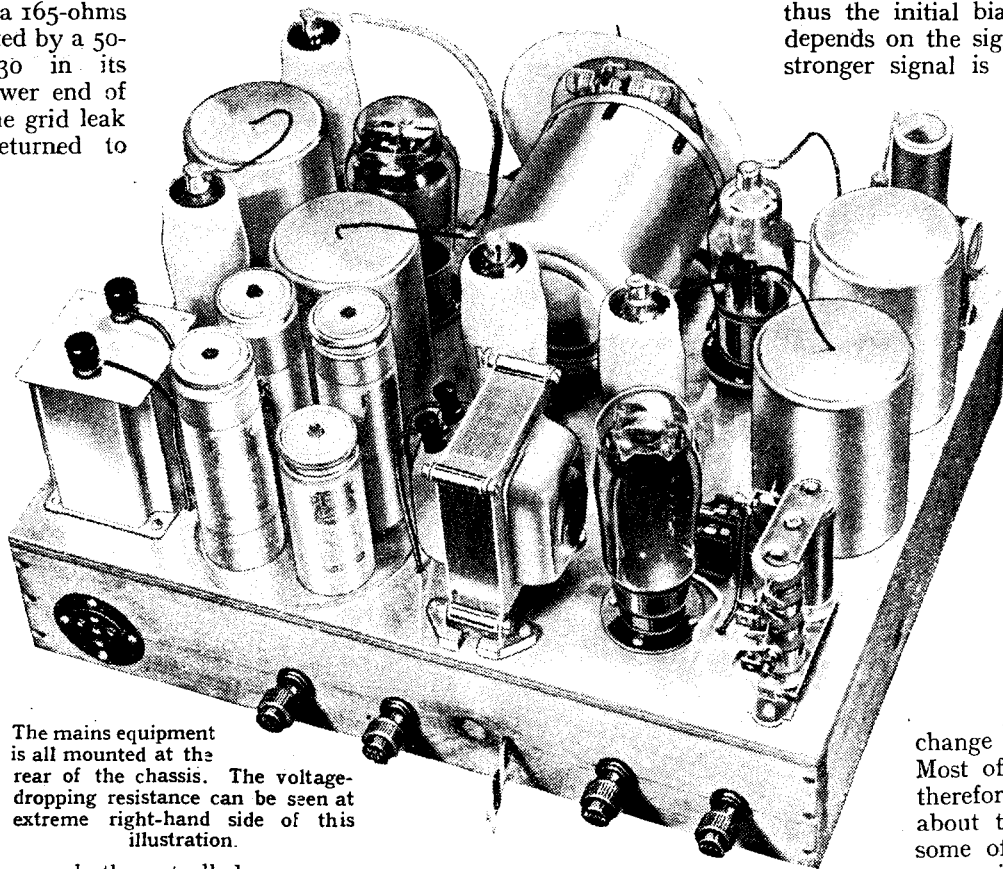

The mains equipment is all mounted at the rear of the chassis. The voltage-dropping resistance can be seen at extreme right-hand side of this illustration.

occurs in the A.V.C. diode, and this diode acquires a potential negative with respect

LIST OF PARTS

After the particular make of component used in the original model, suitable alternative products are given in some instances.

- | | |
|--|---|
| 1 Variable condenser, 0.00016 mfd., C5 Polar Type "E" | 1 Mains resistance, 300 ohms, plus 250 ohms, tapped every 50 ohms, R21 Watmel P25 |
| 1 Dial, Slow motion type Polar Micro-drive semi-circular | 1 Resistor, 25 ohms, R22 Claude Lyons F.W.25 |
| 2 Bulbs, 0.06 amp. Bulgin Type "H" | 1 L.F. choke, Ch3 Wearite H.T.11 |
| 1 H.F. choke, Ch1 Bulgin H.F.8 | 1 L.F. choke, 32 henrys, Ch2 Bulgin L.F.15 |
| (Kinva, Wearite) | (Bulgin, Davenset, Ferranti, Sound Sales, Varley, Wearite) |
| 4 Microcondensers, 100 mmfds., C11, C12, C17, C20 Eddystone 900 | 1 Tapered volume control potentiometer, 250,000 ohms, R13 Claude Lyons Type 250 M-T |
| 1 Compression condenser, 100 mmfds., C7 Colvern | (Ferranti, Magnum, Rothermel) |
| 1 Electrolytic condenser, 4 mfd., C34 Peak Type "W" | 2 Valve holders, 5-pin Clix Chassis Mounting Standard Type |
| 3 Electrolytic condensers, 8 mfd., C27, C28, C33 Peak Type "W" | 6 Valve holders, 7-pin Clix Chassis Mounting Type |
| 1 Electrolytic condenser, 50 mfd., 15 volts, C29 Peak Type D.54 | 1 Rotary Q.M.B. D.P.D.T. Switch, S1 Claude Lyons 2163 |
| 1 Electrolytic condenser, 50 mfd., 25 volts, C30 Peak Type D.52 | 1 Rotary Q.M.B. D.P.S.T. Switch, S2 Claude Lyons 2161 |
| 8 Fixed condensers, 0.1 mfd., C8, C9, C10, C18, C24, C25, C26, C31 Peak Type "M" | 1 Reaction condenser, slow-motion, 0.0002 mfd., C14 Polar Type QJ |
| 3 Fixed condensers, 0.01 mfd., C13, C23, C32 Peak Type "M" | (Eddystone) |
| 1 Fixed condenser, 0.005 mfd., C35 Peak Type "M" | 4 Coil screens, 3 1/2 x 2 1/2 in. diam. Mains Power Radio Type CS1 |
| 2 Fixed condensers, 0.002 mfd., C1, C2 Peak Type "M" | (Goltone) |
| 2 Fixed condensers, 0.001 mfd., C15, C16 Peak Type "M" | 1 Coil screen, 4 x 3 1/2 in. diam. Colvern |
| 1 Fixed condenser, 0.0005 mfd., C36 Peak Type "M" | (Goltone) |
| 4 Fixed condensers, 0.0001 mfd., C5, C19, C21, C22 Peak Type "M" | Materials for Coils: |
| 1 Fixed condenser, 0.0001 mfd., C3 Graham-Farish Bakelite Case Type | 12 in. Paxolin tube, 1 in. diam. Wright & Weaire |
| 1 Fixed condenser, 0.0002 mfd., C4 Graham-Farish Bakelite Case Type | 2 1/2 in. Paxolin tube, 1/2 in. diam. Wright & Weaire |
| (Dubilier, Graham-Farish, T.C.C., T.M.C.Hydra, Telsen) | Quantity No. 32, 36 and 88 D.S.C. wire, |
| 1 Resistance, 80 ohms, R18 Watmel Hy-watt | or 1 Set of Coils. |
| 1 Resistance, 165 ohms, R19 Watmel Hy-watt | 4 Knobs Bulgin K6 |
| 2 Resistances, 250 ohms, R1, R2 Watmel Hy-watt | 1 5-pin Plug Bulgin P.3 |
| 1 Resistance, 2,000 ohms, R7 Watmel Hy-watt | (British Radio Gramophone Co., Goltone) |
| 3 Resistances, 10,000 ohms, R8, R15, R23 Watmel Hy-watt | 1 Baseboard twin fuseholder with 1 amp. fuses Bulgin F.11 |
| 1 Resistance, 20,000 ohms R6 Watmel Hy-watt | (Belling-Lee) |
| 3 Resistances, 50,000 ohms, R3, R5, R9 Watmel Hy-watt | 4 Ebonite shrouded terminals, A. E. Pick-up (2) Belling-Lee Type "B" |
| 4 Resistances, 100,000 ohms, R4, R10, R12, R14 Seradex | 5 Valve cap connectors, thinable type Clix |
| 1 Resistance, 250,000 ohms, R20 Seradex | 2 Lengths screened sleeving Harbros |
| 1 Resistance, 1 megohm, R16 Seradex | 4 ozs. No. 20 tinned copper wire, 3 lengths Systoflex, wood, flex, etc. |
| 2 Resistances, 2 megohms, R11, R17 Seradex | Plymax baseboard, 12 x 15 x 1/8 in. Peto-Scott |
| (Dubilier, Erie, Ferranti, Graham-Farish, Claude Lyons, Seradex) | Screws:— |
| | 4 1/2 in. No. 4 R/hd.; 18 1/2 in. No. 4 R/hd. |
| | 3 1/2 in. No. 6B.A., with metal threads and nuts and washers. |
| | Loudspeaker, with transformer to give primary Impedance of 4,400 ohms. Rola F7-PM29 |
| | Valves:—Mazda, 1 HL.1320, 1 HL.DD.1320, 2 VP.1321, 1 Pen.3520, 1 U.4020; Micromesh, 1 15.D.1. |

The Universal Single-Span Receiver—

Condensers-in the aerial, earth, and pick-up leads are essential, therefore, in order to avoid any possibility of short-circuiting the mains, for either the aerial or the pick-up might accidentally become earthed. Moreover, without these condensers, a shock might be found on handling the connections.

It must not be forgotten, however, that all metal objects in the set itself are connected directly with the mains. These include not only the metal-covered chassis but also the coil screens and the metallising of the valves themselves. Care should be taken, therefore, not to come into contact with any metal part of the set when it is switched on. It is recommended,

therefore, that once the initial adjustments have been performed, the set be included in a cabinet. One point which is often overlooked is to see that the grub-screws in the control knobs are deeply counter-sunk, and the metal pointer supplied with the reaction condenser C14 should not be used.

It should not be thought that a Universal set is in any way dangerous. It is perfectly safe provided that the proper precautions be taken, but as these precautions are unnecessary with the usual type of A.C. set, they are not always fully realised, and it has been deemed advisable to go into the matter at some length.

(To be concluded.)

Trix Power Amplifier Model T.262

A Three-stage High-gain Amplifier Giving 16 Watts Undistorted Output

THE model T.262 power amplifier is one of a wide range of units made by the Trix Electrical Co., Ltd., 8-9, Clerkenwell Green, London, E.C.1, for general-purpose and public-address work. It is a three-stage unit using triode valves in all positions, and the maximum undistorted power output is of the order of 16 watts.

The circuit follows well-tried practice and consists of one resistance-capacity coupling followed by a parallel-fed transformer, the latter feeding two Mullard D.O.26 valves arranged in parallel. The output from these valves is taken from a choke-capacity filter circuit, and as the optimum load for this stage is 2,500 ohms the step-down ratio of the transformer linking the loud speaker to the amplifier must be adjusted to provide this working impedance.

The unit is, of course, A.C. operated and incorporates its own power supply, a valve rectifier in conjunction with a suitable smoothing circuit providing the anode voltages. A point of interest is that provision is made for taking 10 volts or so of D.C.

In addition, the equipment sent in for test included a transverse-current microphone mounted on a floor-type telescopic stand and one of the Trix super-power permanent-magnet loud speakers in a directional baffle cabinet.

The total amplification of the model T.262 unit is a shade over 2,000, and the amplification is practically uniform between 50 and 5,000 c.s., after which there is a slight droop in the curve, and at 10,000 c.s. it is down by 5.5 decibels as compared with the average level. The characteristic curve was taken with the output transformer supplied included in the circuit, and it shows, therefore, the overall performance from the input to the loud-speaker terminals. Taking this into consideration, the performance is most satisfactory.

From further measurements we obtained an output, with absolutely no distortion, of about 11 watts, so that when allowance is made for the customary 5 per cent. of second harmonic, the power output claimed for this model will be easily obtainable under normal working conditions, and, owing to the big

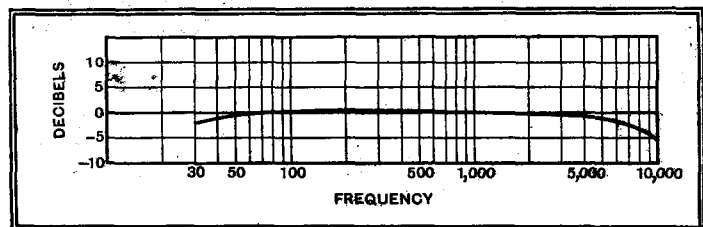

Overall characteristic curve of Trix model T.262 power amplifier, including the output transformer.

for the microphone from the amplifier, a jack point being fitted for this purpose.

The subsidiary apparatus that is used with the amplifier depends largely upon the nature of the installation required. A microphone control box is available to which a microphone and a gramophone unit can be joined and either brought into use by the turn of a switch. The type B control box embodies also connections for the microphone feed and a volume control; this, however, is not effective on the gramophone side, as it is more convenient to have the gramophone control on the turn-table. Independent adjustment of the volume of each source is then possible.

overall gain, this can be achieved with an input of 0.12 volt.

A practical test fully confirmed the deductions of the amplifier's performance from its characteristic curve, and, as expected, the output from the gramophone pick-up had to be restricted to avoid overloading. The small input required is an advantage when using the microphone, for, while it is very sensitive, it does not give a big output, and, in general, more amplification will be needed than for gramophone reproduction. Yet the unit meets this need and has a little in hand, for the volume control does not require to be set at maximum for full output.

The Trix transverse current microphone is a particularly good instrument; judged aurally, it has a well-balanced response, and there are no apparent resonances. Speech is clear-cut, and the characteristic inflections of different voices are easily recognised, while the reproduction of music is in all respects as satisfactory.

The model T.262 amplifier unit costs £26, the microphone control box, type B, £2 17s. 6d., and the microphone, mounted in a floor-type stand finished in chromium plate, £6.

There are several loud speakers in the Trix range suitable for use with this amplifier. They vary in price according to type, but the super-power model fitted in a large directional baffle as illustrated costs £9 10s. Gramophone turn-tables in a variety of styles, also automatic record-changing units, are included among other accessories for public address use in the Trix range of equipment. An output transformer giving the choice of three ratios costs 17s. 6d.

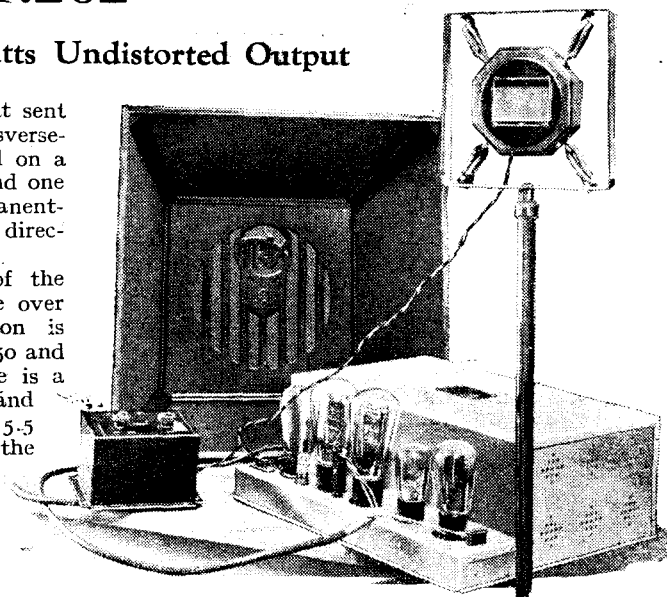

Trix public-address apparatus comprising model T.262 amplifier, microphone, and super-power P.M. loud speaker fitted in small directional baffle.

The Radio Industry

A "DRY TIN" accumulator with a negative electrode of tin, and having no free liquid, is described in a booklet issued by the International Tin Research and Development Council Manfield House, 378, Strand, London, W.C.2.

An advance copy of their new catalogue has been sent to us by Ward and Goldstone, Ltd., of Frederick Road, Salford, Lancs. This publication will shortly be available for general distribution. The same firm has just issued a leaflet describing components for the new Universal Single-Span Receiver.

A G.E.C. battery superheterodyne will provide the British Graham Land Expedition with its only source of news during its stay in the Antarctic, which it is expected will last for two and a half years.

A new Marconi Catkin valve, Type VMP. 4/K, is announced; it is an A.C. variable-mu H.F. pentode with a 7-pin base.

Changes of Address.

T.M.C.-Harwell Sales, Ltd., from Sessions House, London, E.C.1, to Britannia House, 233, Shaftesbury Avenue, London, W.C.2. Telephone, Temple Bar 0055.

Sinclair Speakers, Ltd., from Twyford Street, London, N.1, to 13, Vale Royal, York Road, London, N.7. Telephone North 2235.

News of the Week

Current Events in Brief Review

One in Five

TWENTY per cent. of all American motor cars sold this year either have radio sets as standard equipment or are ordered with portable radio sets installed, according to U.S. trade reports.

Cycle Race Broadcasts

WHAT is probably the greatest cycle race in the world—the *Tour de France*—is the subject of daily running commentaries from the French stations. No fewer than four radio commentators are continuously engaged in reporting the race.

Vive la Femina!

TO have achieved nineteenth place in a radio contest attracting 106 entrants is the feat of little Madeline Mackenzie, of Queensland, Australia, who is only eleven years old. She operated her father's station, VK4GK, and by her own unaided efforts scored 231 points in the British Empire Radio Union transmitting competition. Those who realise what a test of endurance the B.E.R.U. contest is will take off their hats to the young lady.

French High-power Stations

THE French Regional scheme is progressing rapidly. According to our Paris correspondent, the new State station at Villebon-sur-Yvette, near Paris, is rapidly approaching completion. The buildings will include the new P.T.T. transmitter and the Colonial station, which will be transferred from its present site at Pontoise.

The Northern station at Camphin-en-Carembault (Lille), begun on March 28th last, is at the first-storey stage. It is possible that both this and the Paris P.T.T. station may be working before the end of the year.

Television at the Polytechnic

OVER 150 enthusiasts attended the recent series of four lectures on television given by Mr. H. J. Barton-Chapple at the Polytechnic, Regent Street, London, W.1. Demonstrations included the reception of B.B.C. 30-line television on the mirror drum receiver with Kerr cell light modulation on a large screen. During the concluding lecture the Edison Swan Electric Co., Ltd., demonstrated with a cathode-ray tube connected to a portable 30-line transmitter. The tube used was of the hard vacuum type with 1,500 volts on the anode, the size of the received picture being approximately $5\frac{1}{2} \times 2\frac{1}{2}$ in.

English Talk from Warsaw

THE English talk from Warsaw to-morrow evening (Saturday) at 8.30 will be given by Mr. Thad Ordon, who will discuss questions raised in correspondence from British listeners.

"Lightning Stroked"

A PRAGUE Press agency sends us this message: "The Broadcasting-station at Liblice in Czechoslovakia before a short time in their tower had the lightning stroked. The Bohemia Broadcast-listener, who wish through the station thunder and lightning strike, because the Radio send many german programs are, now satisfied."

All's well that ends well.

Good Radiation

ALTHOUGH Radio Bucharest is limited in power to 12 kilo-

The Second Million

ONLY since the inauguration of the wireless licence system in France has it been possible to assess the number of listeners. The total number of listeners in France up to the end of May was 1,554,295.

Morocco Takes Action

AMOSLEM decree against man-made static has just been promulgated in Morocco. The text of the "dahir," as it is called, begins "Praise to God alone," and proceeds to announce that "Our Majesty, the Shereef,

"ULTRA-SHORTS" AT OLYMPIA. Marconi ultra-short wave apparatus kept the judges at the Horse Show in touch with offices behind the stands. The pictures show the transmitter and receiver



watts, the engineers have received reports of reception from New Zealand, Australia, Japan, British Columbia and Cape Town. Quite frequently letters are received from listeners in Egypt, Palestine, Syria and Turkey.

R.S.G.B. Convention

THE annual convention of the Radio Society of Great Britain has, as usual, been arranged to coincide with the Olympia Radio Exhibition, and will be held on the week-end August 24th and 25th.

The 1934 event will be the 9th annual convention that the Society has arranged.

An Intermediate Conference

THE wavelengths of the world will be discussed by the International Radio Consulting Committee, which meets in Lisbon on September 22nd next. The C.C.I.R., as it is called, meets in the interval between the quinquennial International Conferences, such as those held at Madrid in 1932 and Washington in 1927. The C.C.I.R. technicians, representing all nations using radio, will consider such questions as the allocation of wavelengths to various radio services, synchronisation of transmitters, the reduction of interference, and developments in receiving apparatus. Its recommendations will then form the basis for the next International Conference at Cairo in 1937.

Broadcasting Stratosphere Ascent

ELABORATE radio arrangements have been made for the stratosphere ascent of the Belgian balloonists, MM. Cosyns and Vandereelst. A short-wave transmitter installed in the balloon will be used during the ascent for a running commentary, which will be broadcast by one of the Brussels stations.

It is hoped to broadcast a commentary on the landing of the balloon, specially equipped motor cars being kept in readiness to rush to the exact spot.

International 10-metre Tests

ESPECIALLY to foster development on the comparatively unknown 10-metre amateur band, the R.S.G.B. is sponsoring a series of tests on that wavelength, the winner of which will be entitled to hold a trophy in perpetuity. One point will be scored for every 100 miles spanned in the course of radio communication. The contest is open to every amateur transmitter in the world.

A most unusual feature is the fact that these tests will run for twelve months, commencing on October 1st—a course adopted in order that the maximum data about the 10-metre band shall be obtained. A contest of short duration would yield little fruit, as conditions continually vary on the wavelength.

Shakespeare: Father of Wireless

RECENT broadcasts in connection with the Shakespeare anniversary celebration have resulted in a wave of enthusiasm on the Continent. Typical of the Press panegyrics is that of M. Hamerlinck in *Radio Belgique*. "Shakespeare's sublime humanity," he writes, "makes him the most appreciated of broadcast authors. Thanks to radio, the drama of Shakespeare daily exerts a greater hold over the masses, for whom it was intended."

Several French journals have recently contended that Shakespeare is the father of wireless "through his creation of that ethereal spirit, Ariel."

Wireless Transmission of Power?

ACCORDING to New York messages, Nicola Tesla, the noted research worker, claims to have perfected a system of transmitting electrical energy by wireless. As might be expected, journalistic comment predicts a revolution of transport. "I have perfected an entirely new principle in power transmission," says Tesla. "My device is capable of transmitting energy, practically without loss, to any distance."

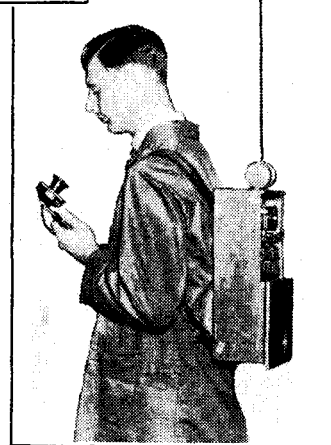

has decided that radio reception must not be troubled by the workings of electrical apparatus of any description."

The decree was signed "at Mekmes, on the 20th Moharrem, 1353," i.e., 4th May, 1934.

Sight and Sound Transmissions at Berlin Show

THE German Post Office are at present working on a second ultra-short-wave transmitter for Berlin-Witzleben. The aerial will shortly be placed at the top of the Berlin radio tower.

Regular sight and sound transmissions will probably start before the opening of the German Radio Exhibition on August 17th.

What Wattage ?

A Rapid Calculator of Resistance Ratings and Values

By C. ATTWOOD, B.Sc.

GIVEN the conditions under which a resistor is to work, the lowest permissible wattage rating is ascertained in a moment from the accompanying chart

THE recent release of half-watt resistances to the general public has once again brought to the fore the question of suitable wattage for a resistance to be used under known conditions. There appears to be a law among manufacturers that the price of a resistance should vary directly as its watts rating, so it will readily be appreciated that a considerable economy can be effected by choosing a resistance of adequate but not unnecessarily generous

rating for the conditions under which it is to be used.

Moreover, with the composition type the physical size of the resistance element as well as the price varies directly as the rating. We can hardly go so far as to say that the new half-watt resistances will enable us to build smaller receivers, for the difference in diameter between the half-watt and the 1-watt types is less than one-tenth of an inch, but we can say that the fact that the weight of the one is almost

half that of the other adds to the rigidity of the wiring of a receiver and enables greater liberties to be taken with spacing when resistances are supported solely by the wiring of a set.

The accompanying chart has been prepared partly for the benefit of those who consider the application of Ohm's law rather irritating when designing a receiver, and also for the more technically inclined, who welcome a rapid means of determining any two of the quantities

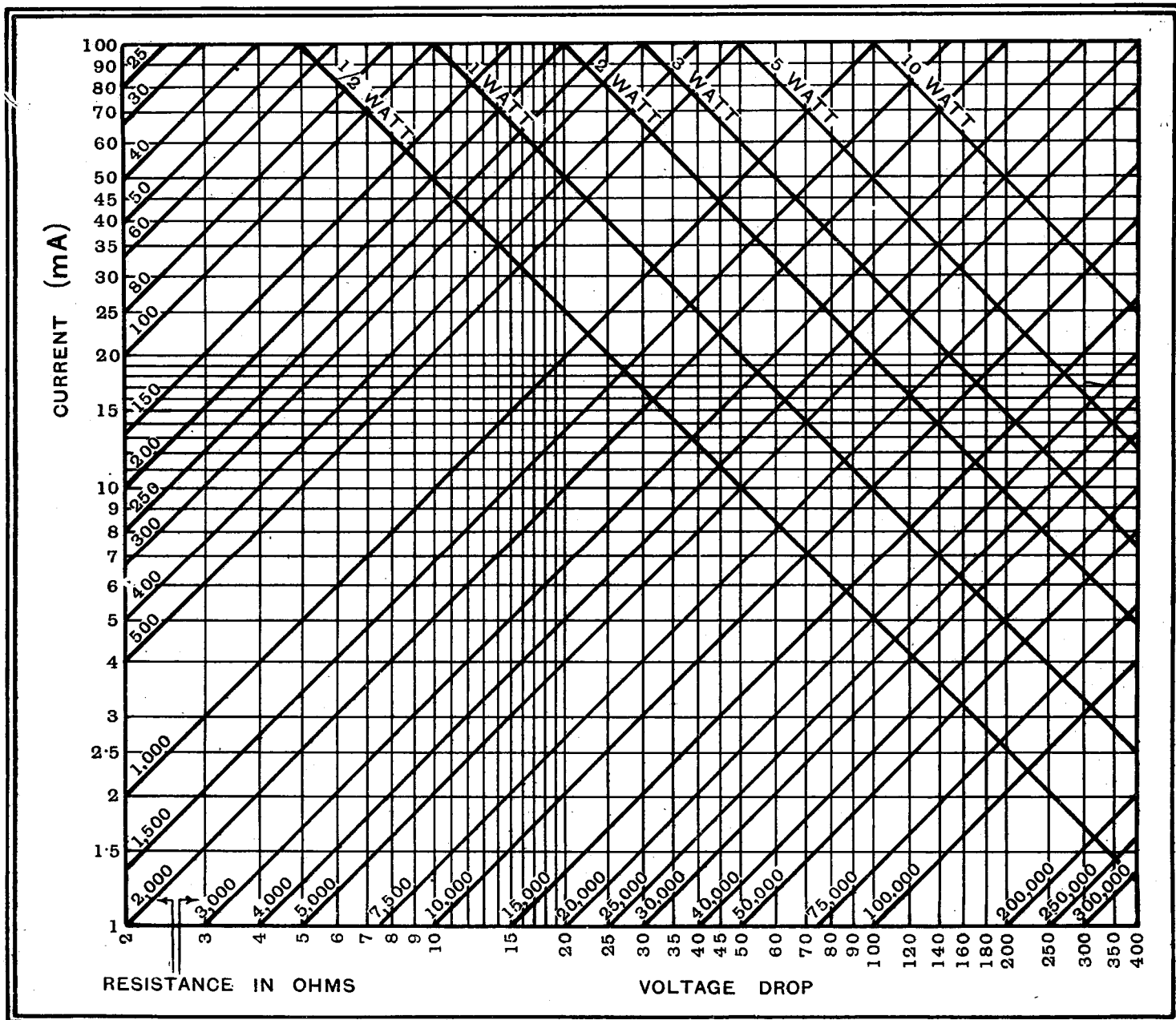

A ready reckoner for evaluating resistance values, voltage drop, current, and wattage rating.

What Wattage?

current, voltage, resistance and wattage when the remaining two are known. The method of using the chart will be clear from the following examples.

The most frequent problem that besets the designer of a modern set is the evaluation of the resistance necessary to drop a known voltage when inserted in a circuit which must carry a given current. At the same time, the necessary watts rating is required. Thus, suppose a resistance is required to pass 20 mA. and to drop 100 volts. We see from the intersection of the lines on the chart that 5,000 ohms is the required value, the necessary rating being 2 watts.

Now, suppose a valve is to be operated at 150 volts, at which voltage it passes 6 mA. The voltage available is 320 volts, and an anode resistance in the circuit has a value of 20,000 ohms. It is required to find the details of a decoupling resistance that will drop the necessary voltage. First, for the anode resistance we see from the chart that 120 volts are dropped in the

anode resistance, and the 1-watt size will be necessary. This leaves 50 volts to be dropped by the decoupling resistance. Again, from the chart the intersection of the lines representing 50 volts and 6 mA. show that 7,500 ohms is the nearest available resistance and the half-watt type will be adequate.

As a last example, suppose a half-watt 50,000-ohm resistance is available. By means of the chart we can say immediately that it cannot be used in a circuit passing more than 3 mA., or, alternatively, the maximum voltage that may be dropped across it is slightly greater than 150 volts.

The outstanding fact that emerges from the chart is that the new half-watt rating fills a definite need, for this rating is suitable for all points to the left of the half-watt line. Indeed, it looks as though there would be a definite place for a rating even smaller than half-watt, but perhaps we are expecting too much when we ask the manufacturers to apply their financial law to an even smaller size of resistance rating.

Brand or Band?

WIMBLEDON or Henry Hall? That is the question. Despite its machine-like precision, the B.B.C. Dance Band is very human, and the hearts that beat beneath those blue tunics are sensitive to a degree. Perhaps only those who have offered of their best to a dead microphone can appreciate the pathos of the Dance Band's case in respect of the interruptions to the afternoon dance music by Col. Brand's tennis commentaries from Wimbledon.

Playing to Itself

It happens again and again, while listeners thrill to the ball pats, that the band is playing to itself, for the red light remains on throughout the session. Mr. Hall is justified in believing that this promiscuous fading in and out upsets the artistic balance of his programmes, besides putting a damper on the enthusiasm of the Boys.

Only Once a Year

The B.B.C. points out that the regular programmes may be "broken into" by the running commentaries, but the boot is on the other foot. The regular programmes occasionally break into the running commentaries.

However, Wimbledon comes but once a year.

The Open Air Theatre

ACOUSTIC problems have always been the big obstacle to broadcasting from the Open Air Theatre, Regent's Park. To avoid all possibility of failure, the Open Air Players are coming to the B.B.C. studio on Sunday next, July 8th, to give what promises to be an exceptional performance of "Twelfth Night."

Among a brilliant cast are Anna Neagle as Olivia, Margaretta Scott as Viola, and Iris Hoey as Maria. The principal male members of the cast are:—Nigel Playfair (Sir Toby Belch, Uncle to Olivia); John Drinkwater (Malvolio); Jack Carlton and Leslie French (Fabian and Feste respectively); Dennis Hoey (Antonio, a Sea Captain); Clifford Evans (Sebastian); Jack Hawkins (Orsino, Duke of Illyria); and Ivor Harries and R. Kerr Carey, gentlemen attending on the Duke.

Controlled Criticism

THE futility of individual criticism" has led Herr Eugen Hadamovsky, director of German broadcasting, to prepare four questions, answers to which he requests listeners to send to their local stations.

Here are the four questions:—

1. Is my station entertaining or boring?
2. Is my station up to date?
3. Has my station an artistic standard?
4. Does my station fulfil my demands as a German Volksgenosse and National Socialist, or has it no policy?

By limiting criticism to these questions, Herr Hadamovsky claims that he will avoid the individual criticism that "loses itself in aesthetics and clings to liberalistic points of view."

BROADCAST BREVITIES

By Our Special Correspondent

Droitwich

LET us take up our *Wireless World* diary, turn to September 6th, and there mark in letters of gold: DROITWICH.

This is the day of days, when the new long-wave station enters upon regular service. The exact manner of inauguration is still under debate; the important point is that we shall then hear whether this long-awaited transmitter is a fit upholder of British prestige amid the welter of kilowatts in the European ether.

A Hypothetical Appointment

BURGHEAD, Morayshire, is somewhat premature in its rejoicings over the "forthcoming appointment" (*sic*) of the first Gaelic-speaking B.B.C. director to take charge of the new Highland transmitter.

According to the *Banffshire Advertiser*, "preference will be given to applicants possessing a knowledge of Gaelic language, literature, and song. They must also be acquainted with Highland life and culture, which the new station is designed to reflect and foster side by side with ordinary entertainment."

Highland Zeal

Unfortunately, Highland zeal is overreaching itself. Burghead will be nothing more than a high-power relay station operated like the other Scottish transmitters from headquarters at Edinburgh. The station may include a small talks studio.

The King to Broadcast

WHEN H.M. the King, accompanied by H.M. the Queen, opens the Mersey Tunnel, the largest under-water thoroughfare in the world, on July 18th, the Royal speech will be broadcast.

It is the rule, when His Majesty addresses the microphone, that all B.B.C. stations shall broadcast the speech, and this occasion will be no exception.

A Long Conversation

LAST week I listened to a telephone talk at Broadcasting House in which two minutes' actual conversation took nearly an hour to conduct. The speakers were using the private line between Portland Place and the B.B.C.'s Manchester headquarters. As happens every morning, the engineers were testing the "S.B." lines, using the private wire for verbal checks. Hence the fact that

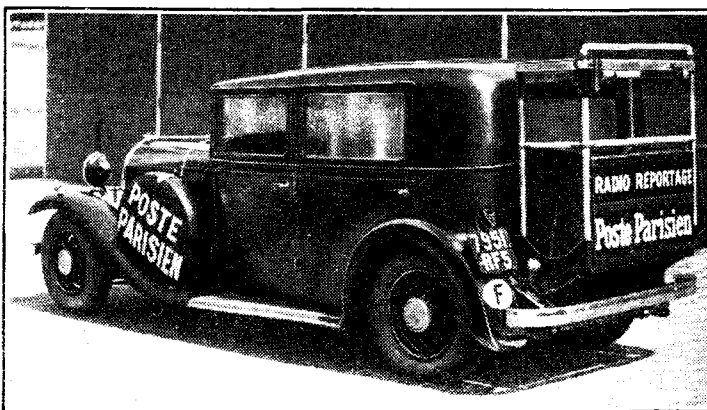

"O.B.s" IN FRANCE. One of the new "radio reportage" cars which *Poste-Parisien* is using to keep listeners informed of the progress of the "Tour de France" cycle contest. Commentaries will be given daily until the end of the month.

the two telephonists were unable to converse continuously for more than fifteen seconds or so.

Broadcasting by Telephone

The same difficulty is experienced in 'phoning to Scotland; sometimes, indeed, it is quicker to send a telegram. One energetic chief, who has occasion to speak to the various provincial headquarters in turn, has proposed a simultaneous telephony system whereby he could be switched through to all centres to convey the message "in one mouthful."

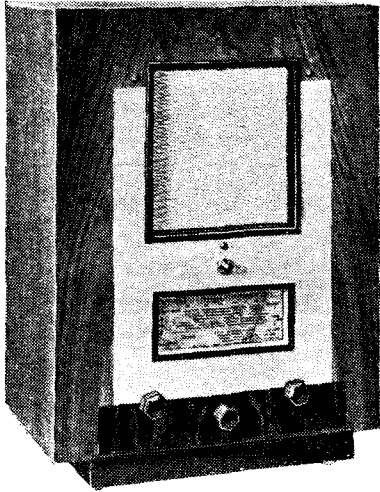

Ferranti Lancastria Superhet

FEATURES.—Type.—Table-model superheterodyne for A.C. mains **Circuit.—**Heptode frequency changer—variable-mu pentode I.F. amplifier—combined double diode pentode output valve. **Full-wave rectifying valve. Controls.—**(1) Tuning, with station and wavelength calibration. (2) Waverange switch. (3) Manual volume control and on-off switch. (4) Tone Control. **Price.—**£12 12s. **Makers.—**Ferranti Ltd., Hollinwood, Lancs.

High Selectivity and Freedom from Whistles

FOR a conservative firm which maintains a consistently high reputation for quality to have produced a mains superheterodyne selling at the modest price of twelve guineas is distinctly an achievement. The Ferranti Lancastria model has a satisfying performance on all counts; moreover, its low price is not brought about by the omission of desirable refinements.

One does not expect a multiplicity of valves in a low-priced receiver, but a total of three (omitting the rectifier), as fitted in this set, may at first sight appear to be small. However, two of the valves are of the multiple type, and a consideration of the circuit arrangement shows that no essential function is omitted.

At the input end of the set we have an inductively coupled band-pass filter with special provision for maintaining constant aerial coupling. Next comes a heptode frequency-changing valve, of which the connections are fairly normal, except that second-channel whistle suppression is obtained by feeding back energy through a coupling coil in the cathode circuit.

The succeeding I.F. stage embodies four circuits forming two band-pass filters; the special connections of the input tuning condenser should be noted.

The function of second detection is carried out by one diode; the other, connected in parallel, provides delayed A.V.C. voltages, which are fed back to both the frequency-changing and I.F. stages. Volume control

is effected by applying any desired proportion of the voltage which appears across the diode load to the control grid of the pentode section of the output valve. Tone control is carried out by manipulation of a variable resistance, in series with a large condenser, in the output circuit. The tuning indicator, which consists of a milliammeter (uncalibrated) is connected in series with the anode of the I.F. valve.

On the mechanical side, the chief feature of the set is the tuning scale, which might perhaps be better described as a tell-tale panel. In addition to the station calibration scale, which consists of a series of staggered dots corresponding to each channel, the panel also bears the tuning indicator and pointers showing the positions of the waverange switch, the volume control, and the tone control. Incidentally, the calibration of the model tested was found to be extraordinarily accurate.

The outstanding features of the Lancastria set are selectivity and freedom from second-channel whistles. Tested in central London, it was found that only one channel was lost on each side of the local stations. So far as more distant transmissions were concerned, selectivity was true "9-kilocycle." On the long waves, a good idea of the performance of the set can be conveyed by saying that Königswusterhausen and Radio Paris were receivable clear of interference from

Daventry, except for a little inevitable side-band splash when the tone control was set at "brilliant." By turning the control to "mellow," this interference totally disappeared; thus providing an excellent illustration of its real usefulness. In the matter of sensitivity, the set is well up to the average standard of its class; although its range is not exceptional, it is quite enough to ensure a really good choice of programmes.

There is a good average bass response,

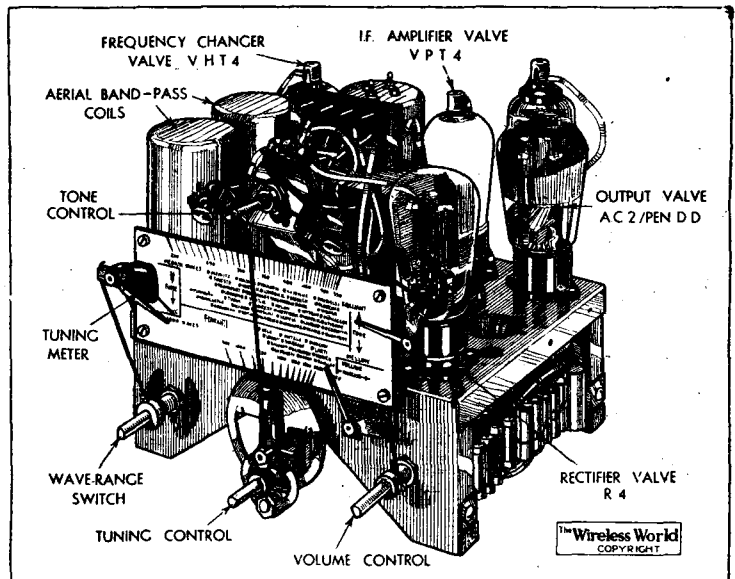

The "tell-tale" tuning panel is a special feature of the Lancastria set.

while, at the other end of the scale, reproduction of the upper register is well maintained up to about 4,000 cycles—of course, with the tone control set to "brilliant"—without obtrusive resonances. Tone control is rather drastic in its action: "mellow" is very mellow indeed, but that is hardly a fault.

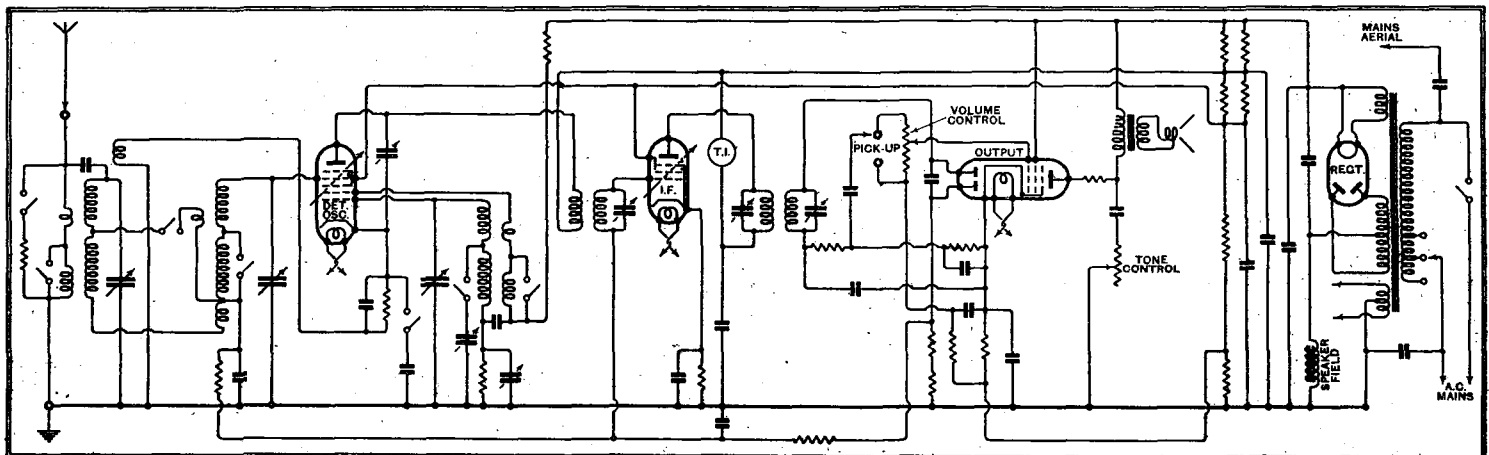

Ignoring the power rectifier and A.V.C. diode, there are five valve stages, but only three receiver valves.

Letters to the Editor

The Editor does not hold himself responsible for the opinions of his correspondents

Vibratory H.T. Generators

THE weakness of a buzzer interruptor used with a step-up transformer seems to be that of an excessive amount of power is absorbed in a buzzer winding. Again, if the interruptor be combined with the transformer, as in the ordinary induction coil, the inevitable large air gap reduces efficiency. To overcome these disadvantages, I have evolved the circuit arrangement shown in the accompanying diagram, which gives perfectly satisfactory results.

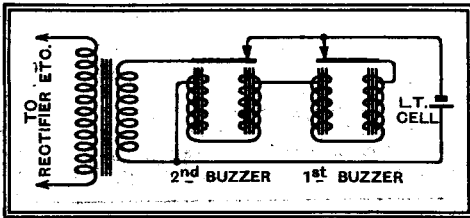

The intermittent current from the first buzzer passes through the coils only of the second, causing the trembler to vibrate, and the contacts of the second make and break the transformer primary current. Thus, the only resistance or impedance in the primary circuit is that of the interruptor contact.

It is desirable that both buzzers should have the same natural frequency, but I find that with care cheap buzzers may be suitably adjusted.
D. A. NEWTON.
Esher.

Car Radio

IN your issue of June 8th, 1934, under "Editorial Comment," we notice an article entitled "Car Radio—Why Copy America?"

The enclosed descriptive circular of the Sonora Auto-Home proves how thoroughly we agree with your article in every respect.* This set, designed, engineered, and created in France for conditions which exist to-day in Europe was first announced to us in full-page advertisements in various French magazines.

Your publication is read each week in eleven different departments of Sonora, and a large amount of interesting material is often gathered from it.

SONORA RADIO S.A.

Puteaux (Seine).

[* The circular describing the receiver indicates that it is a small six-valve super-heterodyne with A.V.C., operating on A.C. or D.C., or from the car accumulator when the required voltage is supplied by a vibrator.—ED.]

Broadcast Frequency Scale

I AM in complete agreement with your previous correspondents on the subject of a broadcast frequency response. I wrote to the B.B.C. early in 1933 making this suggestion, but received the standard reply given to Mr. Ogilvy.

In the interests of those who wish to ascertain that they are getting the most perfect reproduction of the B.B.C. programmes that is possible, I think that a weekly test should be made outside broadcasting hours, and giving standard modula-

tion at frequencies from, say, 30 to 5,000 cycles in some twenty logarithmic steps, allowing half a minute on each step, an announcement of each frequency, and the percentage modulation being made before each step.

There is no doubt that such a transmission would prove of inestimable value to the amateur, who could, by means of one of the low-reading rectifier meters now on the market connected in the set output, obtain the overall frequency response of his set in a most convenient manner—a test which would not otherwise be possible without very expensive laboratory apparatus.

Oxford.

H. WOODHEAD.

The Question of Quality

I HAVE read with interest your editorial comment on the question of quality in *The Wireless World* of June 8th.

I know that the public is supposed to prefer "mellow" reproduction, but it is my experience that if that same public is asked to choose between the so-called "mellow" reproduction and something really first-class, there is never the slightest doubt as to which is preferred.

First-class reproduction is, however, not easy to achieve—partly because of the cost and bulk of the necessary reproducing apparatus, but also to a very large extent owing to the difficulties in making a perfect transmission, which is absolutely essential. Anyone who has listened over a high-quality chain will know how the B.B.C. quality varies from one studio to the next—one transmission being very "tinny," and the next one following it deficient in top. Announcements are a further standing source of complaint, not only because the volume level is too high compared with orchestral

numbers, but also because the stressed vowel sounds are frequently characterised by an unnatural roughness which is caused by wave-form distortion in the microphone itself. When once the wave form has been distorted at the source and spurious harmonics introduced in this manner, the only way of ameliorating matters at the receiving end is by introducing a second fault—namely, cutting the top.

This also removes the frequencies causing the "tinny" in the case mentioned above, and makes the tone quality sound exactly the same as on the transmission which is deficient in top. A uniformly inferior reproduction is thus obtained, which is generally preferable both to the "tinny" reproduction and to that containing spurious frequencies produced by wave-form distortion. The fact that manufacturers have been forced to modify receivers having a good high-note response can thus be explained in a perfectly common-sense and scientific manner.

It is possible that the "tinny" transmissions are an attempt by the B.B.C. to correct for the top cutting which they unintentionally justified in the average set, and it would be interesting to know whether transmissions with an excess of high frequencies do not cause incurable "grasshopper noises" of much lower frequencies in any receiver situated where the field strength of the neighbouring carrier wave is appreciable.

The fact that really first-class transmissions do occur is proof that questions of wave-form distortion and frequency characteristics are being dealt with by the B.B.C.

When such transmissions are the rule instead of the exception, first-class receiving apparatus will come into its own, and the present-day wireless set be consigned to the scrapheap.

QUALITY.

London, S.E.19.

Gramophone Motor Hum

IN a letter on the above subject in your issue of May 25th, Mr. Gilbert Packman was good enough to mention a solution of this trouble which we have suggested to him.

May we say that since then we have asked Messrs. Garrard to come to our assistance. They have now produced for us a modified form of their well-known Inductor motor in which the stray A.C. field has been reduced to a very low level. This has been done by a modification to the windings, and not by the use of extra screening metal in the turntable. The hum induced into the pick-up when using this new motor is practically negligible even when the pick-up is followed by a high degree of low frequency amplification. Previously, when using the same pick-up—our D.P.2—it was no rare thing to get as much as 5 volts of hum appearing at the output terminals in the absence of the precaution mentioned by Mr. Packman.

The extra cost of this modified motor is not, however, negligible, though speaking for ourselves, we are only too glad to pay some shillings more for such a valuable contribution to really "clean" reproduction.

London, W.C.2.

H. B. DAVEY,

Managing Director,

E.M.G. Hand-made Gramophones, Ltd.

AN INVERTED LOUD SPEAKER

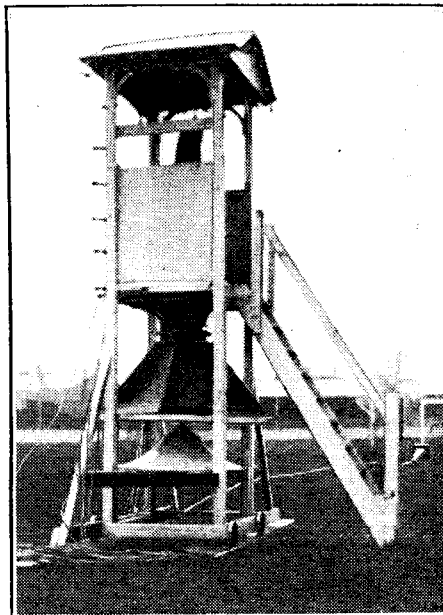

The control box at the Lea Bridge Dirt Track, showing the quadruple Voigt loud speaker with the horn flare immediately above a reflecting cone which distributes the sound evenly over 360 degrees.

Correspondence, which should be as brief as possible, should be addressed to the Editor, "The Wireless World," Dorset House, Stamford Street, S.E.1, and must be accompanied by the writer's name and address.

HINTS and TIPS

Practical Aids to Better Reception

IT is a matter of some importance that an amplifying valve—and particularly a modern high-power output valve—should never be run without sufficient grid bias, even for a short space of time. Failure to observe this precaution will result in the flow of an excessively high anode current, and the valve may be more or less seriously damaged.

Safety and Grid Bias

It will therefore be obvious that when planning an automatic bias system it is worth while to guard against the possibilities of an interruption in the supply of bias to output valves. Nowadays, cathode-circuit biasing, whereby each valve is biased by the flow of its own anode current through a resistor in series with the cathode, is almost universal, and, in addition to being more or less self-regulating, is probably the safest from other points of view. If, for example, the bias resistance should burn out, the valve will not be damaged by excessive anode current, for the very good reason that the anode circuit will be automatically interrupted. The arrangement also has the advantage of simplicity, which in itself reduces the possibility of failure.

Practically speaking, the only eventuality that can interrupt the supply of bias is a lack of continuity between grid and earth. More often than not there is only a single component connected between these points, and so it is an easy matter to assure oneself whether continuity exists.

A CERTAIN number of American pentagrid frequency-changing valves are being used in this country in conjunction with British valves of the normal indirectly heated type. The American valves have heating elements rated at 2.5 volts, while the others have the usual 4-volt heaters. Short of obtaining a special transformer with a $2\frac{1}{2}$ -volt L.T.

Low-voltage Frequency Changers

winding, it accordingly becomes necessary to insert a voltage-absorbing resistance in series with the $2\frac{1}{2}$ -volt heater.

Experience would indicate that there is a natural tendency, in the interests of safety, to make this limiting resistance rather too high in value. As a result, the frequency-changing valve either refuses to oscillate, or perhaps more often, the actual voltage applied to the heater is such that it only just oscillates. After a while, as emission falls off slightly, it is sometimes

found that the set takes an unduly long time to warm up to its work, or else that self-oscillation is unobtainable over the whole tuning range.

The ideal way of putting right shortcomings of this nature is to adjust heater voltage by altering the series resistance with an A.C. voltmeter as a guide. If a suitable instrument is not available it is generally safe to short-circuit two or three turns of the resistor in the event of failure to obtain self-oscillation.

ALTHOUGH a Single-Span receiver is not subject to second-channel interference of the usual type, it is a fact that in particularly difficult circumstances a few "whistles" may be encountered, as with an ordinary superhet. In the immediate vicinity of a powerful station it may happen that these whistles are caused by "beating" between

Suppressing Whistle Interference

harmonics of the oscillator and incoming signals from the local transmitter.

Fortunately, this trouble is not a difficult one to overcome. Probably the best cure is afforded by inserting in the aerial lead to the receiver a simple type of wave-trap to attenuate the local-station signals. In the case of a twin transmitter, it will be necessary to employ two such absorbing circuits, connected in series in the manner shown in Fig. 1. Full constructional details of a twin wave-trap of this type were given in *The Wireless World* for January 26th, 1934, under the title of "Eliminating Second-channel Interference." It may be pointed out, however, that a good deal of latitude is allowable in the construction of this wave-trap, and a satisfactory device can often be contrived with existing apparatus.

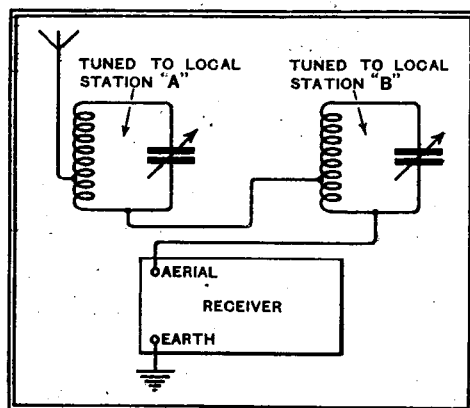
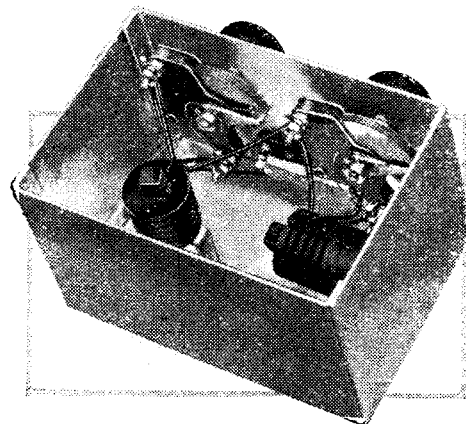

Fig. 1.—A simple form of twin wave-trap which affords the best possible protection against second-channel interference from two local stations.

In use, the circuit (or circuits) of the wave-trap are initially tuned accurately to the wavelength of the stations causing the interference, and no subsequent adjustment should then be needed.

Another point in connection with the operation of Single-Span sets may also be noted. The wavelength coverage of sets operating on this principle is determined by the precise value of the intermediate-frequency amplifier, which, of course, is governed, in turn, by the settings of the condensers which tune the I.F. coils. If, for example, the band of wavelengths covered is not wide enough, we have an indication that the intermediate frequency is too low. The remedy is to reduce the setting of all the I.F. tuning condensers—at a first approximation they may all be reduced to an equal extent—before carrying out the final operation of re-alignment.



Showing the disposition of components in a commercial version (Wearite) of the "Wireless World" Second-channel Whistle Suppressor. Space is saved by the use of iron-cored coils.

IT is worth while remembering that the "trimming" of the aerial input circuit of a receiver will probably need attention after making any considerable alteration to the position of the aerial—even if its length remain unchanged. We all know that the receptive power of an aerial may be improved by increasing its height, but in a case that was recently investigated the beneficial results of raising the "free" end of an aerial by about 12 feet was found to be altogether out of proportion to expectations. Stations that were originally barely receivable in daylight became audible at good programme strength after the alteration.

Altering the Aerial

Part of the improvement was, of course, due to the fact that stronger signals were being picked up by the higher aerial. But it was also found that when the aerial was in its original position the input circuit of the receiver was slightly out of alignment; the trimming condenser had been screwed home rather too far. As a result of raising the aerial, its capacity to earth had been reduced, and by pure good fortune it happened that the receiver became more accurately "ganged" than under the original operating conditions.

UNBIASED



By
**FREE
GRID**

Demolished
guttering by
a simple
process.

To All Concerned

I WONDER how many of you have found out to your cost, as I have, what a confounded nuisance electric clocks can be unless they are wired up on a special circuit of their own.

In the course of my experiments it not infrequently happens that all the fuses of the house get blown, including the main ones. Naturally this results in a stoppage of the electric clocks, and, unless I trudge round and restart them, the time-table of the whole household gets dislocated. Electric clocks of the self-starting type are no improvement, as when the fuses are restored they have to be reset to the correct time.

I have now solved the problem completely by putting in special wiring for my clocks and I strongly commend this idea to wiring contractors who are engaged in wiring new houses or rewiring old ones. To builders of new houses it should, in my opinion, make a strong selling point, as apart from anything else the extra wiring would help to strengthen the walls.

Built-in Aerial

SINCE my complaint about the lack of initiative shown by builders in not incorporating loud speaker points in every room of all new houses I have received many letters of approval from wiring contractors and other interested parties.

From my own experience I know builders to be about fifty years behind the times. In most cases they object to installing radio fittings; when the exception arises they do not call in a skilled technician, but leave the job to the plumbing department.

In a recent case which was brought to my notice a house-hunter had been persuaded to settle down in a particular district, though his heart yearned for a more salubrious one, solely because the builders had advertised that every house was equipped with a scientifically designed "built-in" aerial.

One would have thought that the least that the builders could have done was to

provide a mast at the end of the so-called garden and to have fixed a permanent lead-in insulator, but apparently profits were cut so fine that this would have turned a gain into a loss. They therefore resolved to stick the aerial in the loft.

The technical "expert" had evidently possessed sufficient knowledge to prevent them building the wire into the brickwork as originally intended, but not enough to prevent their running it parallel and in close proximity to the guttering, which got rid of about ninety per cent. of signal strength.

Acting on advice, the proud house-owner has demolished the guttering by the simple process of blowing on it, and while this has restored his signal strength it has brought in all the fun of the fair in the shape of trolley bus noises to which the gutter-spouting had acted as an effective screen.

An Olympia Problem

EXHIBITION time, like Christmas, is getting nearer every day, and it gives me something of a shock to realise that it is now less than two months ahead.

I must confess that I am very worried about the whole business this year. The fly in the ointment is, of course, the enormous success of last year's exhibition.

Last year business was so brisk that, according to reports given to newspapers by prominent manufacturers, the whole of their factory output was booked up to Christmas before the exhibition was an hour old. Before it had closed its doors several firms were booked up for two years ahead.



The baser sort.

It will be obvious to anybody but a born fool that it would be utterly futile for these firms to exhibit again this year, as they couldn't promise delivery of new models until they had completed all last year's orders at the end of 1935 or thereabouts, by which time the Olympia 1934 models would, in any case, be out of date.

So far as I can see there will be merely a handful of manufacturers exhibiting at this year's show, and these of the baser sort whose products failed to bring in many orders last year.

A New Clock

LIKE the Athenians of old, I am always intensely interested in anything new, and the B.B.C.'s experiment with time has firmly gripped my imagination. The one great obstacle to making it a complete success, in my opinion, has been the fact that clock dials have not been altered in sympathy.

It is therefore with delight that I acclaim the introduction of a new type 24-hour clock and watch which has recently been shown me. Many people are familiar with those timepieces which show the actual figures, such as "3.42," instead of using a dial and hands. The new clock is built on this principle, but it covers the whole twenty-four hours, showing "3.42" as "15.42," and so on.

I have been told that the B.B.C. is shortly to set an example by replacing all the clocks at Broadcasting House with this type, and it is hoped that a roaring trade will be done in them, providing, as they do, what the shops call "something

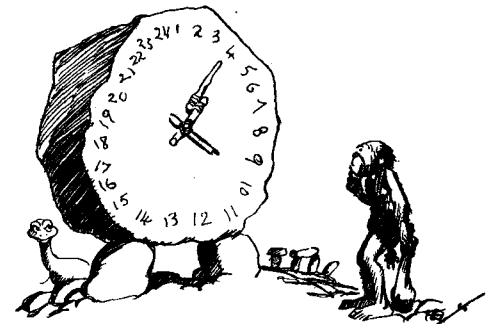

So antique.

different" as presents at weddings, birthdays and such like dismal functions. I hear also that many firms intend to incorporate this type of clock in the new receivers for Olympia.

As to the B.B.C.'s policy in regard to 24-hour time, my only feeling is one of surprise that they should foist on us something so antique. That it is antique there can be no doubt. I notice that my pre-war "Italy" Baedeker says: "In official dealings the old-fashioned Italian way of reckoning the hours from 1 to 24 has again been introduced. Thus 1 p.m. is *alle tredici*, 8 p.m. *alle venti*." If I were Director of the B.B.C. such Victorian tactics would not be permitted, but the whole method of reckoning time would be modernised by using the decimal system, the day being divided into ten hours, each consisting of ten minutes, and so on. Similarly, there would be ten days in a week, ten weeks in a month, and ten months in a year.

If we must preserve the ancient names, instead of using the number of the month, I would suggest that we name them appropriately by following the example of the last four months of the year. Thus the fifth month would be known as Quinquember, and so on. It is true that in theory the seasons would be somewhat upset, but in practice this would scarcely be noticed, as students of our climate know only too well.

POLAR

SPECIFIED

★ WITHOUT ALTERNATIVE ★

for the

UNIVERSAL SINGLE-SPAN

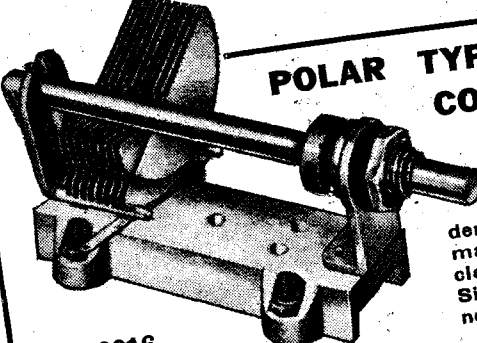

POLAR TYPE 'E' CONDENSER

Constructed on STEATITE base. All banks of vanes soldered together and made of chemically cleaned hard brass. Silent rotor connections.

.00016
5/-

Also made in 2-gang, Price 10/6

● SEND FOR POLAR CATALOGUE

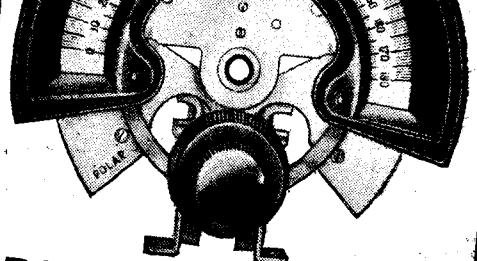

POLAR MICRO-DRIVE SEMI-CIRCULAR

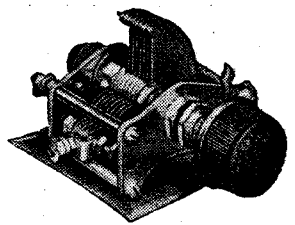

POLAR TYPE Q.J. SLOW MOTION REACTION CONDENSER

Constructed entirely in brass. Ball bearing spindle. Moving pointers. Supplied with knob

.0002
6/-

With two reduction ratios, 100 to 1 and 7 to 1, each operated independently by concentric knobs. Bevelled scale marked in 0-180 degrees. Moulded escutcheon. Lampholder. Complete with baseboard fixing bracket.

7/9

Also made in "Arcuate" and "Horizontal" types at 7/9 and Moving Scale at 6/8.

WINGROVE & ROGERS LTD.
188/189, STRAND, LONDON, W.C.2

Phone: Temple Bar 2244. Works: Old Swan, — LIVERPOOL.

Proved Best by the Test of COMPARISON...

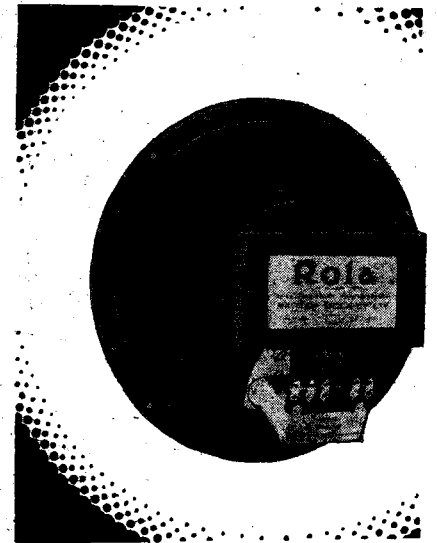

that is why

ROLA MODEL F7-PM29

(Price 60/-)

is the "Wireless World's" **SOLE SPECIFICATION** for the **UNIVERSAL SINGLE SPAN RECEIVER.**

An outstanding set deserves an outstanding speaker. Without one no receiver can achieve its highest standard of performance. The "Wireless World" has chosen Rola Model F7-PM29 **exclusively** for the Universal Single Span receiver because Rola speakers are "the world's finest reproducers" and the F7-PM29 is the finest of all Rola models. Backed by ten years of scientific research and practical experience, produced by the most modern speaker factory in Europe, Rola speakers are proved the best by every test it is possible to apply . . . and the most satisfactory test of all is one which you can apply yourself—the test of **comparison**. Ask your dealer to demonstrate a Rola speaker. Compare it with any other unit you care to select. You will find that for tonal brilliance and realistic reproduction Rola speakers stand absolutely alone. Ask your dealer to-day.

● ROLA EXTENSION SPEAKERS

There is a correct Rola Extension Speaker for practically all British Radio receivers. Rola speakers are used by nearly all British Radio Manufacturers. As it is highly desirable to have the speech coil impedance of the Extension Speaker similar to that of the speaker in the receiver the necessity for using Rola Extension Speakers is manifest. Write to-day for the Extension Speaker Broadsheet.

Write to-day for the Rola Folder.



THE BRITISH ROLA CO. LTD.
Minerva Road, Park Royal,
N.W.10.

Phone: Willesden 4322-3-4-5-6.

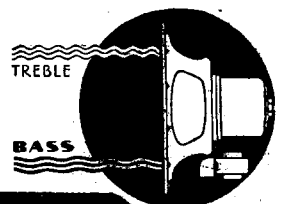

THE "W.W." PUSH-PULL QUALITY AMPLIFIER AS A COMPLETE P.A. SYSTEM !

Price of complete amplifier including Collaro motor and pick-up in specially designed walnut cabinet **£25** (illustrated below)

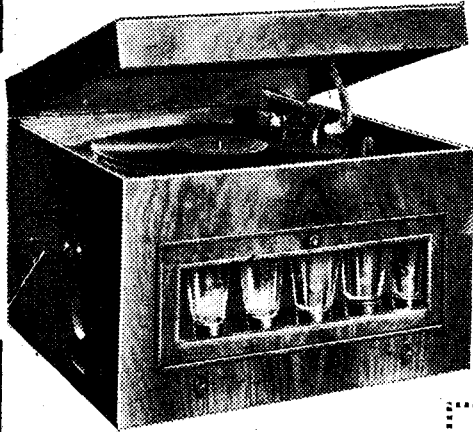

WE BELIEVE that a large section of listeners are waiting for an amplifier in which superlative quality of reproduction is put before everything else. The "W.W." Push-Pull Quality Amplifier is the nearest approach to this ideal, and can be relied upon to give an almost linear response from 20 to 10,000 cycles. The general fidelity of reproduction and the rendering of transients must be heard to be believed.

WE ARE PLEASED TO ANNOUNCE that we are including this amplifier as one of our standard productions for the coming season.

A double-diode triode is used as a phase changer, which permits of an input of gramophone or radio at will.



**18-20, NORMAN'S BUILDINGS,
CENTRAL STREET,
LONDON, E.C.1**

Phone: Clerkenwell 6206 (3 lines) Telegrams: Cityacco, Barb, London.

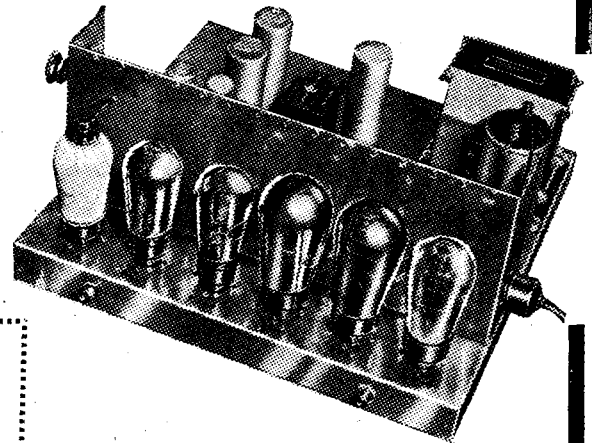

COME & LISTEN to the Push-Pull Quality Amplifier fed alternatively from a gramophone or radio source, at our Demonstration Rooms.

"AUSTIN"
RECEIVERS, RADIOGRAMS & CABINETS
will be more conspicuous than ever on the
Largest Stand at Olympia
and, of course, at
Glasgow & Manchester

"W.W." Readers who are desirous of constructing the Push-Pull Quality Amplifier, should send to us for complete price lists of the various components, including correctly drilled aluminium chassis as specified by the Designer.

First and Foremost!
CLIX
Specified for every one of the
"Wireless World"
**SINGLE-SPAN
RECEIVERS**

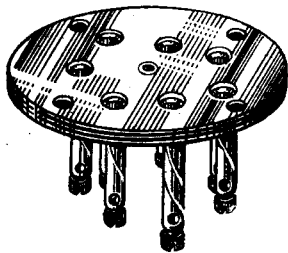

**Clix Chassis Mounting
VALVEHOLDERS**
7-Pin... 1/- 5-Pin... 9d.

The "Wireless World" also specifies Clix latest perfect contact component.

**THE CLIX
VALVE CAP
CONNECTOR**
Five required for the
Universal Single-Span
Receiver.

Obtainable from all dealers.

PRICE
1 1/2d.
EACH



Lectro Linx Ltd., 79a, Rochester Row, London, S.W.1.

THOMPSON'S (VICTORIA) LTD.
17, Strutton Ground, Westminster, S.W.1

Telephone: Franklin 6355.
Open every day until 7.30 p.m. (Saturdays 1.30 p.m.)
**ALL GOODS ON THREE DAYS' APPROVAL AGAINST CASH
OR C.O.D. (I.F.S. EXCEPTED).**

Read carefully to your advantage. Stupendous summer clearance. Wonderful bargains at amazing prices.

REGENTONE "UMELLO" A.C. MAINS ELIMINATOR with trickle charger, output 120 volt 20 m.a., 2 volt 1/2 amp., 27/6, post 1/-.
REGENTONE A.C. MAINS ELIMINATOR, type W.I.C., output 120 volt 20 m.a., 3 pos. tappings, 1 variable, 25/-, post 1/-.
B.T.H. UNIVERSAL GRAMOPHONE MOTOR complete with turntable for 100-250 volt mains, A.C. or D.C., list 3 Gns., our price to clear, 30/-, post 1/6.
THOMPSON'S PUBLIC ADDRESS TRANSVERSE CURRENT MICROPHONE (Eugene Reisz principle) on HEAVY PLATED TELESCOPIC stand, 55/-, post free.
HIGH GRADE P.A. MICROPHONE for home broadcasting and recording, etc., 35/-, post 1/-.
HIGHLY SENSITIVE BROADCAST MICROPHONE complete on heavy nickel plated stand, 17/6, post 9d.
TRANSFORMERS FOR ALL MICROPHONES, 5/6 extra.
G.P.O. SOLID BACK MICROPHONES, 4/6 each, post 6d.
DUBILIER 2 mf. 1,000 volt test Condensers, 1/9 each, post 3d.
DUBILIER 4 mf. 1,000 volt test, 2/6 each, post 3d.
HIGH GRADE (NON INDUCTIVE), 1 mf. 1,000 volt test, 1/4 each, post 3d.
Ditto, 2 mf. 1,000 volt test, 1/9, post 3d.
PHILCO 8 mf. ELECTROLYTIC Condenser, 400 v. working, 2/3, post 3d.
AEROVOX 8 mf. ditto, 400 volt working, 1/- each, post 3d.
VIKING FULL VISION DIAL, listed 8/6, to clear 2/6 post free.
VIKING DUAL APERTURE DIAL, list 8/6, to clear 2/3, post free.
VIKING DRUM DRIVE, listed 8/6, to clear 2/6, post free.
CELESTION P.M. MOVING COIL SPEAKERS, matched Pentode, Power or Push pull, listed 45/-, to clear 22/6, post 1/-.
ROTHERMEL P.M. SPEAKER, matched Pentode or Power, listed 27/6, to clear 15/6, post 1/-.
SONOCHORDE 2,500 ohm field MOVING COIL SPEAKER, matched Pentode, 11/6, post 1/-.
THOMPSON'S A.C. MAINS ELIMINATORS, output 150 volt 25 m.a., 3 pos. tappings, 25/-, post 1/-.
THOMPSON'S D.C. ELIMINATORS, output 150 volt 30 m.a., 3 pos. tappings, 10/-, post 1/-.
MAINS TRANSFORMERS by well-known makers, 300-0-300 60 m.a. 4-volt 2 amp., 4 volt 3 amp., 5/6, post 1/-; 185 volt 100 m.a. 4 volt 3 amp. C.T. for Westinghouse H.T.8, 5/6, post 9d.; 300 volt 60 m.a. 4 volt 4 amp. C.T. for Westinghouse H.T.9, 5/6, post 9d.
MAINS TRANSFORMERS for Westinghouse H.T.5, 3/9, post 6d.
MAINS CHOKES, 20 henry 40 m.a., 2/- each, post fd.; 30 henry 60 m.a., 2/9, post 6d.; 30 henry 80 m.a., 3/3, post 6d.
MARCONI MICROPHONE TRANSFORMERS, ratio 70 to 1, 4/6, post 9d.
BEAUTIFUL POLISHED WALNUT TABLE CONSOLE CABINETS, 17 x 14 1/2 x 9 1/2, 8/6, post 1/3. See also announcement in Classified Section.

Soldered contacts are better
ELECTRICALLY SOLDERED ARE BEST

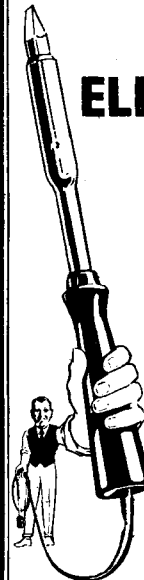

Switch on a Solon Electric Soldering Iron and in three minutes it is ready for use. It plugs into a lampholder.

Use a

SOLOON
TRADE MARK
ELECTRIC SOLDERING IRON

7/6

60 watts 7/6
125 22/6
(1 lb. 1 oz.)
240 watts 37/6
(2 lbs.)

If unable to obtain, send us the name of your nearest dealer.
W. I. HENLEY'S TELEGRAPH WORKS COMPANY LTD.
Y.M15 Dept.—HOLBORN VIADUCT—LONDON—E.C.1

BRITISH THROUGHOUT

MISCELLANEOUS ADVERTISEMENTS

NOTICES.

THE CHARGE FOR ADVERTISEMENTS in these columns is

12 words or less 3/- and 3d. for every additional word.

Each paragraph is charged separately and name and address must be counted.

SERIES DISCOUNTS are allowed to Trade Advertisers as follows on orders for consecutive insertions, provided a contract is placed in advance, and in the absence of fresh instructions the entire "copy" is repeated from the previous issue: 13 consecutive insertions 5%; 25 consecutive, 10%; 52 consecutive, 15%.

ADVERTISEMENTS for these columns are accepted up to **FIRST POST** on **MONDAY MORNING** (previous to date of issue) at the Head Offices of "The Wireless World," Dorset House, Stamford Street, London, S.E.1, or on **SATURDAY MORNING** at the Branch Offices, 19, Hertford Street, Coventry; Guildhall Buildings, Navigation Street, Birmingham, 2; 280, Deansgate, Manchester, 3; 26a, Renfield Street, Glasgow, C.2.

Advertisements that arrive too late for a particular issue will automatically be inserted in the following issue unless accompanied by instructions to the contrary. All advertisements in this section must be strictly prepaid.

The proprietors retain the right to refuse or withdraw advertisements at their discretion.

Postal Orders and Cheques sent in payment for advertisements should be made payable to **ILIFFE & SONS LTD.**, and crossed **& Co.** Notes being untraceable if lost in transit should not be sent as remittances.

All letters relating to advertisements should quote the number which is printed at the end of each advertisement and the date of the issue in which it appeared.

The proprietors are not responsible for clerical or printers' errors, although every care is taken to avoid mistakes.

Set Manufacturers' Surplus, Clearance and Bankrupt Stocks offered in any of these columns may not be Manufacturers' current lines. Radio components advertised at below the list price do not carry any manufacturer's guarantee.

RECEIVERS AND AMPLIFIERS, ETC.

- L. EASTWOOD** Sound System.
- R**EPRODUCTION that is Almost Perfect.
- T**YPE R32 2-stage Resistance Coupled Amplifier, having 3½-watt pentode in output stage, supplied in steel case, complete with B.V.A. valves and Rola M.C. speaker; price 7 guineas.—Write Dept. A., Pitfield St., N.1. Clerk. 7693. [6053]
- R**33. Radiogram, 4-valve, £15 R.I. converter, as new; sacrifice both, £22.—Popesgrove 3139. [6026]
- 2-VALVE** (Plus Rectifier) Mains Set, quality reproduction, oak cabinet, M.C., B.V.A. valves; £5/10.
- 3-VALVE** (Plus Rectifier) Ultra-selective S.G. Set, quality reproduction, B.V.A. valves, walnut cabinet; £7/10.
- 4-VALVE** (Plus Rectifier) 2 S.G. Set, chassis only, B.V.A. valves, pentode output; £5/10.
- 5-VALVE** Overhauled Columbia Portable, with new Cossor valves, oak cabinet, ideal holidays; 50/-.
- MICHAEL** Supervoxx (A.C.), twin speakers, and B.V.A. valves; bargain at 11 guineas.
- SURREY RADIO**, 37, Rosehill Park West, Sutton, Surrey. 'Phone: 4591. Demonstrate anywhere. [6025]
- D**EAL Direct with the Main Source of Supply and Save the Middlemen's Profits.—See Thompson's advert, on page 2. [6066]
- £6/15.**—Superhet A.C. 200-250, 2 H.F. pentodes and pentode output, in futuristic walnut oblong cabinet, M.C. speaker, unused, list £11/11; complete with valves.
- £4/10.**—200-250 A.C. band pass S.G.3, in attractive walnut case similar to Lotus, complete with valves and Rola M.C., 3-gang Radiophone, screened coils, listed £10/10, brand new; ditto table radiogram, Simpson turntable, Belling Lee pick-up, complete, for £5/15.
- 55/-.**—S.G.3 band pass battery receiver, as above, with P.M. Rola or Sonochoerde (without valves, batteries); listed £8/8; similar set S.G.3, 2-gang Polar, Ormond loud speaker, in identical cabinet, for 42/6.
- 67/6.**—Class "B" 4-valve S.G. band pass, as above (without valves, batteries), Magnavox P.M.; listed £10/10.
- 60/-.**—Class "B" 3-valve band pass, in superb horizontal two-colour walnut cabinet, Radiophone 2-gang in metres, Rola P.M. (without valves, batteries); listed £9/9.
- 70/-.**—Super Sixty superhet battery receivers, in beautiful walnut cabinets, standing on tables, with concealed frame aerials, complete with coils; listed £14/14.
- 25/-.**—2-valve battery, in superb 2-colour walnut cabinet, metal chassis.
- 55/-.**—S.G.3 band pass battery set, in attractive walnut case, complete with Rola or Sonochoerde P.M., 3-gang Radiophone.
- S**END for a Photo of Any of the Above; all c.o.d., carriage forward.—Kay, 167, City Rd., London, E.C.1. [6048]

PILOT

AUTHOR

KITS

Exact to Specification

EXPORT ORDERS Simply send full cash value plus a suitable amount for half carriage charges and any surplus will be immediately refunded. Packed free, we pay half carriage. Air Mail charges extra. P.E.T.O.-SCOTT, established in 1919, are the largest Radio-by-Mail House in the World. **Hire-purchase terms are NOT available to Irish or Overseas Customers.**

UNIVERSAL SINGLE SPAN

"KIT A" Comprising Author's Kit of first specified parts, less valves and cabinet. **£10.2.6**
Cash or C.O.D. Carriage Paid
Or 12 monthly payments of 18/6.

"KIT B" As for Kit "A," but including set of first specified valves. **£15.17.6**
Cash or C.O.D. Carriage Paid
Or 12 monthly payments of 29/-

KIT-BITS

You pay the Postman. We pay post charges on all orders over 10/-

- 1 P.E.T.O.-SCOTT Plymax Chassis, 12" x 15" x 2¼" - 9 9
- 1 Set of P.E.T.O.-SCOTT Coils 12 6
- 1 Set of 7 SPECIFIED VALVES 25 15 0
- 1 ROLA type P.T. P.M.29 Speaker with Transformer to give primary inductance of 4,400 ohms 23 0 0

SINGLE SPAN COILS

FULL COIL ASSEMBLY Complete set of 7 coils, ready wound and assembled in Ready-drilled Screens, complete with associated Eddystone, Polar and Colvern Condensers and Resistance. Cash or C.O.D. **47/6**
Carriage Paid
or 6/- deposit and 8 monthly payments of 5/9. With Mirror Drive 7/9 extra.

A.C. SINGLE SPAN

- RECEIVER KIT £7 10 0
- POWER UNIT KIT 25 2 6
- COMPLETE KIT including set of specified valves, but less cabinet £18 8 6

BATTERY SINGLE SPAN

- RECEIVER KIT £8 12 6
- OUTPUT KIT £1 13 9
- COMPLETE KIT including set of specified valves, but less cabinet £12 16 0

P.E.T.O.-SCOTT CO. LTD.
77 CITY RD., LONDON, E.C.1 'Phone: Clerkenwell 9406/7
West End Showrooms: 62, High Holborn, London, W.C.1. Est. 1919.

SOUND AMPLIFYING EQUIPMENT

for all purposes, with undistorted A.C. outputs from 2 to 150 watts—Heavy duty M.C. speakers, microphones, etc. Tannoy sound equipment is used whenever quality is the first consideration.

Consult—
THE
"SOUND
PEOPLE"

TANNOY

PRODUCTS
(GUY R. FOUNTAIN LTD.)
CANTERBURY GROVE
WEST NORWOOD,
LONDON, S.E.27,
and Branches.

Telephone: Streatham 6730 (3 lines).

Wherever Moving Coil Speakers are PRAISED AND ADMIRING, THE NAME

BAKER

IS ON THE TIP OF THE TONGUE, RECOMMENDED AND SOLD BY DEALERS EVERYWHERE

BAKER SELHURST RADIO LTD. SUSSEX ROAD, CROYDON

NUMBERED ADDRESSES.

For the convenience of private advertisers, letters may be addressed to numbers at "The Wireless World" Office. When this is desired, the sum of 6d. to defray the cost of registration and to cover postage on replies must be added to the advertisement charge, which must include the words Box 000, c/o "The Wireless World." All replies should be addressed to the Box number shown in the advertisement, c/o "The Wireless World," Dorset House, Stamford Street, London, S.E.1. Readers who reply to Box No. advertisements are warned against sending remittance through the post except in registered envelopes; in all such cases the use of the Deposit System is recommended, and the envelope should be clearly marked "Deposit Department."

DEPOSIT SYSTEM.

Readers who hesitate to send money to advertisers in these columns may deal in perfect safety by availing themselves of our Deposit System. If the money be deposited with "The Wireless World," both parties are advised of its receipt.

The time allowed for decision is three days, counting from receipt of goods, after which period, if buyer decides not to retain goods, they must be returned to sender. If a sale is effected, buyer instructs us to remit amount to seller, but if not, seller instructs us to return amount to depositor. Carriage is paid by the buyer, but in the event of no sale, and subject to there being no different arrangement between buyer and seller, each pays carriage one way. The seller takes the risk of loss or damage in transit, for which we take no responsibility. For all transactions up to £10, a deposit fee of 1/- is charged; on transactions over £10 and under £50, the fee is 2/6; over £50, 5/-. All deposit matters are dealt with at Dorset House, Stamford Street, London, S.E.1, and cheques and money orders should be made payable to Iliffe & Sons Limited.

SPECIAL NOTE.—Readers who reply to advertisements and receive no answer to their enquiries are requested to regard the silence as an indication that the goods advertised have already been disposed of. Advertisers often receive so many enquiries that it is quite impossible to reply to each one by post. When sending remittances direct to an advertiser, stamp for return should also be included for use in the event of the application proving unsuccessful.

Receivers and Amplifiers, Etc.—Contd.

- MARCONI** 60 Watt A.C. Amplifier, type P13, 110-250v., suitable for microphone, gramophone, or radio, in polished oak cases, complete with valves; £12/10 each.
- IGRANIC** 60 Watt A.C. Amplifier, 110-230 volts, metal chassis, complete with valves; £12/10.
- PHILIPS** 200 Watt A.C. Amplifier, 220 volts, double channel type, splendid condition, complete with Philips output valves; £25.
- G.E.C. P.A.**, 60 Watts, in teak cases; last few to clear, £2/10, components worth double!!!
- A**MPLION Exponential Horn Type Speakers, in water-tight cases, 6 volt field, £5; 230 volt A.C., £5/15.
- L**ARGE and Varied Stock of P.A. Amplifiers, microphones, speakers, converters, heavy duty chokes, transformers, meters, condensers, etc.; stamp for lists and prices; callers invited.
- H. FRANKS**, 23, Percy St., Tottenham Court Rd. W.1. Museum 8585. [6035]
- MARCONIPHONE** 276 7-valve A.C. Superhet, need one month, absolutely as new, list 22 guineas; price £16/10.—Newburys Radio, 46, Mayes Rd., Wood Green, N.22. [6059]
- 4-VALVE** Superhet Midgets 1935 models, A.C. or D.C., M.C. speaker, £3/19/6; 5-valve, £5/5, including valves; c.o.d.; write catalogue.—Royal, 5, Buckingham Rd., London, E.18. [5939]

- A**RMSTRONG.—Latest 6-stage superheterodyne chassis, Heptode frequency changer, A.V.C. £6/18/6, including Marconi valves, Royalties paid; Armstrong 3-pentode, 4-valve chassis, full band pass, £5/18/6, including valves.
- A**RMSTRONG.—Universal chassis, band pass, 3-tuned circuits; £5/18/6, including valves; any chassis 7 days' trial.—Armstrong Co., 100, King's Rd., N.W.1. [6051]
- O**PPORTUNITY!—G.E.C. "Superhet, 5" A.C. radiogram, £26/5, 15 guineas; "Arcadia" Console, £24/3, 14 guineas; McMichael Duplex "S.M.C." portable, £17/17, £12; all brand new, unused.—Particulars (bankrupt stock), 151, Wellingborough Rd., Northampton. [6043]

OUR Kit for "Wireless World" Quality Amplifier, complete in every detail, including valves, amplifier only, £8/10; feeder unit, 36/-; carriage paid; cash with order or c.o.d.; send for detailed list of components.—Ward, 2nd Floor, 45a Farringdon St., London, E.C.3. Holborn 9705. [5760]

PUBLIC Address Amplifiers—A.C. mains, three stage, 21 watts, undistorted A.C. output, complete with valves, £15; universal A.C./D.C. three stage, 7 watts output, complete, £13; guaranteed 12 months; trade supplied; deferred terms.—D. E. Clarkson, B.Sc. (Eng), 45, Manor Rd.; Wallington, Surrey. 'Phone: Wallington 3953 [6046]

MIDGET Receivers, brand new (ideal for actors, travellers, etc.), operate on any voltage 100-240 A.C./D.C., Emerson 5-valve chassis, moving coil speakers, pick-up terminals, M and L wave, sealed cartons, complete with valves, £3/15; the above chassis, incorporated in handsome figured walnut cabinet, (10x7½x5½), list 10 gns., at £4/6/3; carr. paid, cash with order or c.o.d.; Halson 4-valve superhets, 100-250 A.C./D.C., M.C. speaker, walnut cabinets, list 12 guineas, at £4/7/6; also (6 only) Sparton "63" 6-valve superhets, M.C. speaker, walnut cabinets (12½x7½x4½), 100-250 A.C./D.C., guaranteed over 70 stations, at £7/10, carr. paid, cash with order or c.o.d.; demonstrations only 12.30-1.30 or 7.30-9 p.m.—Degallier's, 4, Coryton House, 21, Upper Marylebone St., London, W.1.

MAINS EQUIPMENT.

VORTEXION Leads Again.
VORTEXION Specified Single Span Model, 350-100 m.a., 4v. 5a. C.T., 4v. 2.5a. C.T., 4v. 1a. C.T.: 25/-. less terminals, 23/-. less 5-year guarantee 21/-; power chassis, complete, £3/10; steel chassis only, 7/6; also normal model, shrouded, at 16/-. special shrouded choke 12/6.
VORTEXION—Quality amplifier or super monodial, 425-0-425, 120 m.a., 4v. 6-8a. C.T., 4v. 3a. C.T., 4v. 1a., 4v. 1a., super shrouded, core size 2 1/4 in. x 1 1/2 in., 2 1/2 regulation primary engraved insulated terminals, weight 14lb., 26/-, carriage 2/-; normal shrouded, 22/-; open type, 20/-, post 1/3; speaker field replacement choke, 16/-; special output transformer, to "W. W." spec. 12/6.
VORTEXION 7-30h. 120 m.a. Choke, 215 ohms, in die cast shrouding to match; 12/6.
IMITATED, but unequalled. Good enough for a "Wireless World" specification is good enough for you.
VORTEXION Cost Little More than the Cheapest, but unequalled by the dearest.
VORTEXION Standards Despatched by Return.
VORTEXION A.C./34 used by author in construction of A.V.C. Three, as illustrated; 18/-.
GUARANTEED 12 Months, and within 5% normal and 2 1/2% super models, neat shrouding, with detachable feet, as used by Government Departments, etc.; any model guaranteed 5 years at extra cost of 2/-.
A.L.L. Secondaries Centre Tapped.
VORTEXION.—250-0-250 60 m.a. 4v. 1 to 2a., 4v. 2 to 4a., open type, 10/-; shrouded, 12/6; post 9d.
VORTEXION.—Ferrocart III, 350-0-350, 60 m.a., 4v. 2.5 C.T., 4v. 3.5 C.T.; open type 13/6, shrouded 16/-; post 9d.
VORTEXION.—Super model for H.T.8 or 9 or 10, 4v. 1 to 2, 4v. 2 to 4; open type 14/6; shrouded 16/6; post 9d.
VORTEXION.—350-0-350, 120 m.a., 4v. 2 to 5a., 4v. 2 to 4a., 4v. 2.5a.; open type, 14/6; shrouded, 16/6; super shrouded model, weight 11lb., 4 filaments to specification, 21/-; post 1/3.
VORTEXION.—400 or 450 or 500v. 120 m.a., 4v. 2 to 5, 4v. 2 to 5, 4v. 2.5a.; open type, 19/-; shrouded, 23/-.
VORTEXION.—400 or 450 or 500, 150 m.a., 4v. 4a., 4v. 2.5, 4v. 2, 4v. 2, 4v. 2, core size 2 1/4 x 1 1/2 in., a super job, 2% regulation, 35/-; shrouded, with terminals; less terminals, 30/-; open type, 26/-; post 1/3.
VORTEXION Auto Transformers to B.E.S.A. Specification, 100, 110, or 120v. to 200, 220, or 240 volts, 60 watts, 9/-; post 9d.; 120 watts, shrouded, 12/6, open type 10/6, post 1/-; 200 watts, shrouded 16/6, post 1/-; 2,000 watts, £4/10.
VORTEXION 1,000-watt Transformers; £4/10, carriage free.
VORTEXION 30h. at 60 m.a. Chokes, 5/6; 40h. at 60 m.a., 8/6; 30h. at 150 m.a., 200 ohms, 10/6 open type, 12/6 shrouded
VORTEXION Transformers Made to Your Specification; price according to wattage, 6v. filaments same price unless wattage grossly exceeded; special quotations by return.
VORTEXION (S. A. BROWN), 182, The Broadway, Wimbledon, S.W.19. Tel.: Liberty 2814. [5901]
SERADEX Products Specified for
UNIVERSAL Single-Span Receiver; full details to be announced next week.
SERADEX Coils for Above Receiver, with cans, condensers, etc.; £2/12/6; detailed specifications on request.
SERADEX Loud Speakers; full details announced next week.
TREVOR PEPPER, 575, Moseley Rd., Birmingham. [6054]
SPECIAL Offer: 1,000 Tantalum strips, 5/2 in. x 1-16 in., suitable for trickle chargers; 1/3 each.
TANTALUM for A.C. Chargers, H.T. and L.T.—Blackwell's Metallurgical Works, Ltd., Garston, Liverpool. [5039]
DEAL Direct with the Main Source of Supply and Save the Middlemen's Profits.—See Thompson's advert. on page 2. [6063]
SOUND SALES, Ltd., Transformers and Chokes specified "Wireless World"; lists free.—Tremlett Grove, Highgate, N.19. [0401]
HOYNE'S Transformers, fitted with tapped and screened primaries, filaments, all centre tapped, stout cast aluminium clamps and clearly marked terminal strips are fitted to all models; write for list.
HOYNE'S Components are Guaranteed for One Year; one type only manufactured, the best, as used by many well-known set manufacturers after testing all others.
HOYNE'S—"W.W." transformers, wound strictly to specification of author.
HOYNE'S—Push-pull quality amplifier transformer, 25/-, post 1/3; 7/30 henrys choke, 9/6, post 9d.; 20 henrys, 7/6, post 9d.
HOYNE'S—Push-pull quality amplifier, complete to "W.W." specifications, wired and fully tested, less valves: £5/2/6
HOYNE'S—Single span, 15/-, post 1/-; choke, 10 henrys, 7/6, post 9d.
HOYNE'S—Everyman A.C. super transformer, 12/6, post 1/-; choke, 10 henrys, 7/6, post 9d.
HOYNE'S—A.V.C. Straight Four transformer, 18/-, post 1/3; choke, 26 henrys, 120 m.a., 140 ohms, 9/6, post 9d.
HOYNE'S—A.V.C. Three transformer, 12/6, post 1/-; choke, 30 henrys 60 m.a., 7/6, post 9d.
HOYNE'S New Monodial Transformer; 24/-, post 1/3.
HOYNE'S.—250-0-250v. 60 m.a., 4v. 1 to 2a., 4v. 2 to 4a., 10/-, post 9d.; with extra 4v. 1 to 2a. winding, 12/6, post 1/-.
HOYNE'S.—Ferrocart III, 350-0-350v., 60-70 m.a., 4v. 1 to 2a., 4v. 2 to 4a., 12/6, post 1/-; with extra 4v. 1 to 2a. winding, 13/6, post 1/-.
HOYNE'S.—350-0-350v., 120 m.a., 4v. 2 to 3a., 4v. 4 to 6a., 4v. 1a., 4v. 1a., 18/-, post 1/3.
HOYNE'S.—400 or 450 or 500v., 120 m.a., 4v. 2 to 3a., 4v. 2 to 5a., 4v. 1 to 2a., 18/-, post 1/3.
HOYNE'S.—500-450-0-450-500v., 140 m.a., 4v. 2 to 4a., 4v. 4 to 6a., 4v. 2a., 4v. 2a., 27/6, post 1/3; weight 1 lb.
HOYNE'S Transformers, built to specifications up to 1 K.V.A. keenest prices, best materials and workmanship; quotation by return.
M. J. HOYNE, Offices and Works, 8a, Gladstone Rd., Wimbledon, S.W.19. Tel.: Liberty 3303. [5889]

HARTLEY-TURNER RADIO LTD.

beg to announce that the
HARTLEY-TURNER LOUD SPEAKER, KIT SETS and GRAMOPHONE AMPLIFIERS

will not be reduced in price during 1934

Our policy is to offer only that apparatus which is good as can be made; this implies the individual attention of skilled craftsmen and the large amount of hand-work in Hartley-Turner products results in cost of manufacture being high. A good workman has to be paid well, otherwise imperfect goods are liable, sometimes inadvertently, to be sold.

Additions to our products will be revealed at Olympia and we look forward to meeting old customers and also those enthusiasts to whom "REALISTIC REPRODUCTION" is of vital interest, but who have not yet become possessors of our apparatus.

HARTLEY-TURNER RADIO LTD., Thornbury Rd., Isleworth, Mdx. TELEPHONE: HOUNSLOW 1854.

EXPERIMENT! Try a "DYTAN" For THREE DAYS at OUR EXPENSE

ARE YOU CONTENT to have ugly wires and poles when you can hook up the "DYTAN" (Dynamic Tuned Antenna), on back of set and enjoy excellent reception? Gives fine tone and selectivity, reduces static, ends dangers from lightning and shorts. Simple to fix. No upkeep costs. Ideal for all H.F. radios. With sets of lesser sensitivity, gives extra pickup and act as wavetraps if used with existing aerial. 3 x 5 ins. 7/6 complete, post free. Satisfaction or money back.



HEARING IS BELIEVING. For a 3-days Free Trial of the "DYTAN" merely snip out this advertisement and send it to us with your name and address on a postcard. If for any reason the "DYTAN" does not suit your set, return it to us without further obligation. Otherwise remit 7/6 in full payment.

From Sole European Distributors: E. M. BERRIMAN (Dept. 7) 7, Broadway, Ludgate Hill, London, E.C.4.

BATTERY CHARGER. Will handle 50 accumulators in series at once, with sliding resistance and meter. In steel cubicle. TRADE PRICE £8 8 0 net. Terms arranged, Models for A.C. and D.C. mains, also H.T. chargers with Westinghouse or valve rectification. Chargers made specially to order. Send specification for Quotation.
FEL-EGTRIC RADIO, Garden St., SHEFFIELD

EX-B.B.C. ENGINEER

having purchased an established business desires to meet gentleman with a view to partnership. Write, BOX 797, "Wireless World."

AMERICAN TYPE VALVES

Philco Valves — all with a definite guarantee — are suitable for all American makes of radio sets.
Philco Type 80—Full Wave rectifier 350 volts, 125 m/a — Price 8/- 6A7, 2A7 and 1A6 Heptodes at 16/-
Write for Full Price List or for price of special type required giving the maker's type number.
The Philco Radio and Television Corporation of Gt. Britain Ltd., Valve Dept., Perivale, Middlesex, Phone: Perivale 3344

Mains Equipment.—Contd.

A.C. or D.C. Chargers for 2 to 200 Cells at Low Prices; all sizes; Brown's Generator, battery superseder for H.T. for 2v. or 6v. input, 37/6 and 52/6; television and sewing machine universal motors, 25/-; lists.—Electradix Radios, 218, Upper Thames St., E.C.4. [0398]
PARAMOUNT Mains Transformers are Equal to Any, yet unequalled in price; guaranteed for 12 months, and manufactured from the finest British materials; they are fitted with mrt aluminium shrouds and frames, all filaments centre-tapped; finest quality insulating paper between each layer, and thoroughly tested before leaving our works.
PARAMOUNT 500-0-500v. or 450, or 400, 120 m.a., 4v. 5a., 4v. 4a., 4v. 2.5a., shrouded, screened primary, 21/-; open, 18/-; post 1/3.
PARAMOUNT Single Span 350-0-350v. 100 m.a., 4v. 5a., 4v. 2.5a., 4v. 1a., shrouded, screened primary, super regulation, 18/6, post 1/-.
PARAMOUNT 350-0-350v. 120 m.a., 4v. 2.5a., 4v. 2-4a., 4v. 2-5a., shrouded, screened primary, 16/-, post 1/-.
PARAMOUNT 250-0-250v. 60 m.a., 4v. 1-2a., 4v. 2-4a., 10/-; shrouded, 12/-, post 9d.
PARAMOUNT Chokes 30h. 60 m.a., 5/-, post 9d.; 20h. 120 m.a., 8/-.
PARAMOUNT Auto-transformers 100-120/200-250v. or vice versa, 60 watt 8/-, 120 watt 10/-, shrouded 12/-, post 9d.
PARAMOUNT Guaranteed Electrolytic Condensers, 4-0-4 mid. 500v. peak, 3/6, post 3d.
PARAMOUNT for H.F.8, 9, or 10 4v. 1-2a., 4v. 2-4a., 15/6, shrouded, post 1/-.
PARAMOUNT—Write for details of our super induction 5-valve receiver, with Rola moving coil speaker, Colvern Ferrocart coils, Polar condensers, and variable Mu valves; price £9; there is no greater value on the market, irrespective of price.
PARAMOUNT Mains Transformers, manufactured by Brock & Salter, 66, Hartfield Rd., Wimbledon, S.W.19 (one minute from Wimbledon Station). Tel.: Liberty 3226. [5998]
A.C. Eliminators.—A limited supply of H.T. units, 200-250 volts 40-60 cycles, 160 volts 25 m.a. output, 3 tappings, also suitable for P.P.P. and Class "B," incorporating "Westinghouse metal rectifier," "Dubilier condensers," wire wound resistances, fully guaranteed 12 months; order now; 30/-, carriage paid.—Acton Manufacturing Co., 60, Craven Park Rd., N.W.10. [6041]

CABINETS.

MANUFACTURERS' Clearance.
ULTRA "Panther," a modern cabinet, with contrasting figured walnut veneer panels, 20x17x11, 13/6; pedestal type, 35x22x12, 30/-, undrilled; photo sent on request.
SET and Speaker Cabinets; 5/- upwards.
RADIOGRAM Cabinets; 37/6 upwards.
SPEAKER Cabinets; 4/6 upwards.
SEND Particulars of Your Requirements (giving size of set, etc.), or call and make your choice from our stocks of over 100 different types; from 3/6 to £4/10.
REFER to Previous Advt. for Detailed List of Bargains.
H. L. SMITH and Co. Ltd., 287-9, Edgware Rd., London, W.2. Tel.: Paidd. 5891. [6052]
PLAYING Table, with record storage, 3ft. high; 50/-; Bond, 8, Petersham Rd., Richmond, Surrey. [6038]
DEAL Direct with the Main Source of Supply and Save the Middlemen's Profits.—See Thompson's advert. on page 2. [6062]
ILLUSTRATED List of Radio-Gramophone Cabinets at Bargain Prices, and descriptive literature of the Howe box baffle, recommended by the B.B.C., post free.—Gilbert, Cabinet Maker, Swindon. [0431]

DYNAMOS, ETC.

HOLTZER-CABOT Converter, 120 volt D.C. to 250 volt A.C., 5 amps., trip starter, 5-inch voltmeter and ammeter; £3, or offers.—"Radiocraft," Whitley Bay. [6024]

LOUD-SPEAKERS.

27/6 !!!—Brand new B.T.H.-R.K. speakers, 6v. field, suitable for P.A. work, etc.
£2/7/6 !!!—B.T.H. speakers, as above, for 100-250v. A.C., complete with field rectifier.
MAGNAVOX D.C.152 (9in. cone), 22/6; Magnavox 154 (6 1/2 in. cone), 18/3; all with hum-bucking coils, power or pentode transformers and 2,500 or 6,500-ohm fields; Magnavox P.M.254, 18/-.
ATTENTION to All Orders Within 24 Hours; carriage ward; cash with order or c.o.d.
WARD, 2nd Floor, 45, Farringdon St., London, E.C.4. Telephone: Holborn 9703. [5723]
DEAL Direct with the Main Source of Supply and Save the Middlemen's Profits.—See Thompson's advert. on page 2. [6067]
VAUXHALL—Magnavox permanent magnets, universal, suitable for Class "B," power or pentode, 6in. cone 15/6; 7in. cone 17/6; 10in. cone 23/-; mains energised 2,500 or 6,500, 10in. cone 23/-; 7in. cone 15/3; brand new, with humbucking coils; state power or pentode transformer; Blue Spot P.M.29M, suitable for Class B. pentode, super power and power, 21/-; unused manufacturers' stock; immediate delivery, carriage paid, cash with order or c.o.d.—Vauxhall Utilities, 163a, Strand, W.C.2. Temple Bar 9338. [6008]

TRANSMITTING APPARATUS.

RADIOMART.—See under Components, or send for list G5N.1, 19, John Bright St., Birmingham. [6056]
VALVES.
ALL Types of Brand New American Valves in Stock; first-class makes, guaranteed.
247, 235, 851, 89, 19, 46, 59, 6A7, 15, 42, 83, 43, 12/-, 25Z5, 14/6; U.X.171A, U.X.199, U.X.280, U.X.245, U.X.226, U.Y.227, 7/6; U.X.250, U.X.210, U.X.231, 17/6; U.X.867 photoceels, 25/-; various transmitting valves in stock; post paid; cash with order or c.o.d.
WARD, 2nd Floor, 45, Farringdon St., London, E.C.4. Phone: Holborn 9703. [5722]

Valves.—Contd.

FREE—List of American and non-ring valves and many others, bargains.—Epton, 93, New Road, Chingford, S.4. [5987]

SURPLUS Valves—All brand new; battery types, 2-volt, H.F.2, L.F.2, L.P.2, 1/9; super power, P.P.2, 2/6; screens and pentodes, 3/9; A.C. mains, 4-volt 1 amp., general purpose, 3/3; power, 4/3; screens and pentodes, 4/6; full wave rectifiers, 3/6; postage paid, cash with order, or c.o.d. over 10/—Clarion Radio Valve Co., 885, Tyburn Rd., Erdington, Birmingham. [6032]

PREMIER SUPPLY STORES announce the Purchase of the Complete Stock of a World Famous Continental valve manufacturer; all the following standard main types fully guaranteed, 4/6 each; H., H.L., L. power, medium, high, low mag., and variable mu screen grids, one, three and four Watt A.C. output, directly heated pentodes, 250v. 60 m.a. full wave rectifiers, d.c. types, 20v. 18 amp., filaments, screen grid H., H.L. power.

THE Following Types, 5/6 each; 350v. 120 m.a., full wave rectifier, 50v. 120 m.a. full wave rectifier, 2½ Watt indirectly heated pentode.

THE Following American Types, 4/6; 250, 112, 171, 210, 245, 226, 47, 46, 24, 35, 51, 57, 58, 55.

PREMIER SUPPLY STORES, 20 and 22, High St., Clapham, S.W.4. [6011]

COMPONENTS, ETC., FOR SALE.

R. WALL'S RADIO, 33, Chancery Lane, London, W.C.2 (nearest Tube: Chancery Lane; bus 67 passes door, or tram to Savoy St.). Holborn 3529. Open Saturday afternoon. Close 7 p.m., Saturday 5 p.m., Thursday closed 1 o'clock.

BRITISH Radiophone Volume Controls, with mains on-off switch, new, 5,000, 10,000, 15,000, 20,000, 50,000, 100,000, 2/6 each.

BRITISH Radiophone Radiopacks, 2H.F., 30/-; B.P. superhet 110 kc/s, 30/-; postage 1/3; sets British Radiophone 3-coil units on base, with terminals, wave change, switch and knob, 2 H.F., 8/9; B.P. superhet 110 kc/s, 8/9; postage 9d.

FERROCART Coils, G1-2-8, 25/-; G10-14-8, 25/-; all with mains switch.

T.C.C. 0-1 Non-inductive Tubular Condensers, 10d. each, 350v.; T.C.C. electrolytic 15 mfd., 50v., 1/4. new; T.C.C. 0.01 mica, type M, 1/-; T.C.C. 0.0001, type M, 5d.; H.M.V. condenser blocks, 250v. working, 4x4 mfd., 3/6; 4x4x1x1½ mfd., 4/-; T.C.C. 0.1x0.1, 450v. working, 1/6.

HELSPY Non-inductive Condensers, bakelite cased, 4 m.f., 250v.w., 3/-; Ryall's 4 m.f., 250v.w., 2/-; 750v.w., 6/8; Dubilier 2 m.f., 250 v.w., 1/6; Dubilier electrolytic, 450v. peak, 3/-; 8 m.f. ditto, 4 m.f.

UNIKNOBS, Polar 2-gang, new, brown, 8/-, with cover, 9/6; Polar disc drive, complete with Polar No. 4 0.0005 condenser, listed 9/-, 4/- the two; R. and A. type output transformers, 18-23-32-1, new, 5/-; Paxolin formers, with guides, 1in., 8d.; R.I. Hypermite transformers, 6/-, second-hand; R.I. Paraleed transformers, 5/-, second-hand.

RADIOPHONE Disc Drives, less escutcheon, fit ½in. spindle, read 0-100 from left to right; 1/6 post free. [6033]

PREMIER.

PREMIER SUPPLY STORES Offer the Following Set Manufacturers' Surplus New Goods at a Fraction of the Original Cost; all goods guaranteed perfect, carriage paid over 5/-, under 5/- carriage forward, I.F.S. and abroad, carriage extra.

SPECIAL Offer of P.M. and Energised M.C. Speakers, from well-known gramophone manufacturer.

TYPE 10971G, 9in. diameter, 115 ohm field, 120-200 m.a., with power output transformer, handle 4 watts; 17/6.

TYPE 10971C, 9in. diameter, 2,000 ohm field, 40-70 m.a., Pentode transformer, handles 4 watts; 17/6.

TYPE 10955F, 9in. diameter, 11,650 ohm field, 20-30 m.a., auditorium type power transformer, handles 10 watts; 30/-.

TYPE 10955H, 9in. diameter, 115 ohm field, 350-400 m.a., auditorium type Pentode transformer, handles 10 watts; 30/-.

TYPE 4480B, 9in. diameter, permanent magnet, handles 4 watts, 7 ohms speech coil, 13/6; Multi ratio transformer, 4/6 extra.

ELIMINATOR Kits, including transformer, choke, Westinghouse metal rectifier, T.C.C. condensers, resistances and diagram, 120v., 20 m.a., 20/-; trickle charger 8/- extra; 150v., 30 milliamps, with 4v. 2.4 amps C.T. L.T., 25/-; trickle charger 6/6 extra; 250v., 60 milliamps with 4v., 3.5 amps C.T. L.T., 30/-; 300v., 60 m.a. with 4v., 3.5 amps, 37/6; 200v., 100 m.a., 39/6.

PREMIER Chokes, 40 milliamps, 25 hys., 4/-; 65 milliamps, 30 hys., 5/6; 150 milliamps, 30 hys., 10/6; 60 milliamps, 80 hys., 2,500 ohms, 5/6; 25 milliamps, 20 hys., 2/9.

ALL Premier Guaranteed Mains Transformers have Engraved Terminal Strips, with terminal connections, input 200-250v., 40-100 cycles, all windings paper interleaved.

PREMIER H.T.7 Transformer, output 135v. 80 m.a. for voltage doubling, 8/6; 4v. 3-4a., C.T. L.T., 2/- extra; with Westinghouse rectifier giving 200. 30 m.a., 17/6.

PREMIER H.T.8 and 9 Transformers, 250v., 60 m.a., and 300v. 60 m.a. rectified, with 4v. 3-5a. and 4v. 1-2a. C.T. L.T. and screened primary, 10/-; with Westinghouse rectifier, 18/6.

PREMIER H.T.10 Transformer, 200v. 100 m.a., rectified, with 4v. 3-5a., and 4v. 1-2a. C.T. L.T. and screened primary, 10/-; with Westinghouse rectifier, 18/6.

PREMIER Mains Transformers, output 250-0-250v. 60 m.a., 4v. 3-5a., 4v. 2-3a., 4v. 1-2a. (all C.T.), with screened primary; 10/-.

PREMIER Mains Transformers, output 350-0-350v. 90 m.a., 4v. 3-5a., 4v. 2-3a., 4v. 1-2a. (all C.T.), with screened primary; 10/-.

PREMIER Auto Transformers, 100-110/200-250v. or vice versa, 100-watt; 10/-.

L.T. Transformers, 4v. 3a. C.T., 6v. 2a. C.T., 9v. 1a., 12v. 1a., 5/6 each; 4v. 3-5a., 22v. 1a., 8/6 each; 10v. 3a., 14v. 4a., 10/- each.

SPECIAL Offer of Mains Transformers, manufactured by Philips, input 100-120v. or 200-250v., output 180-0-180 volts 40 m.a., 4v. 1 amp., 4v. 3 amps., 4/6; 200-0-200v., 4v. 1a., 4v. 3a., 4/6.

(This advertisement continued in third column.)

ELECTRADIX

SALE OF A £1,000 LABORATORY EQUIPPED FOR ELECTRICAL RESEARCH & TESTING.

BARGAINS

A wonderful collection of the Highest Grade British Apparatus all to be sold at sacrifice prices.

NO REASONABLE OFFER REFUSED.

Campbell Vibrating A.C. **GALVO**, unifilar. Tinsley Box Type Reflecting A.C. **GALVO AND SCALE**, 3in. x 4in. x 8in. New Cambridge Vibrating A.C. **GALVO**, bifilar; list £23. A Tinsley Moving Coil Ballistic **GALVO**, A Fine Laboratory Moving Coil **GALVO**; Tripod lens tube. Sullivan vertical Marine **GALVO**, suspended moving coil; mirror gives deflection of .05 micro-amp.; with Universal shunt box. A Kelvin Electrostatic **VOLTMETER**, 40 v. to 160 v. Ferranti ditto, 50 v. to 150v., new. Everest panel type ditto, 8in. dial, 1,000 v. to 6,000 v. Siemens ditto, 8in. dial, 2,000 v. to 10,000 v. X-Rays Ltd. vertical ditto, 4in. dial, 6,000 v. to 100,000 v. A Portable A.C. sub-standard **VOLTMETER**, 0-100 v. and 0-400 v.

Large Hot Wire **AMMETER**, 14in. dial, 150 amps. A Portable sub-standard 2-range Hot Wire **AMMETER**, A.C., 1 amp. and 5 amps. A ditto, ditto **AMMETER**, 0-5 amps. Elliott Works Test A.C. **AMMETER**, 8in. dial, ranges 5a, 25a, 100a and 400a, **OSCILLATOR**. All mains 5 valve steel case 24" high. **FREQUENCY TUNING FORK**, electrically maintained, 12in. vertical type; adjustable frequency.

SPECTROMETER, by Adam Hilger, with prisms for Spectrum Wavelengths, Type D1/D2; list £53. Set of **FREQUENCY METERS**, switchboard type, 47/52 cycles, 90/105 cycles, 260/280 cycles, 310/380 cycles, 500/600 cycles. Two Portable **FREQUENCY METERS**, 200-300 cycles. A Portable **FREQUENCY OSCILLATOR**, 10-40 kilocycles, with meter. A Paul **FREQUENCER**, 80 to 800 cycles, portable. A Panel **FREQUENCY METER**, 50 to 90 cycles, 6in. dial.

Nalder Recording Chart **AMMETERS**, 5 amps., D.C. type. A nearly new Elliott Recording Chart **VOLTMETER**, 0 to 250 v. D.C. A **MICRO-AMMETER**, recording at timed intervals on clock chart by relay. A Nalder Multi Range **TESTING SET**, 2 dials; ranges—volts: 75 m.v., 3 v., 30 v., 150 v., 600 v.; current—15 m.a., 1.5 amps., 150 amps., 1,200 amps. Nalder **AMMETER A.C.** Portable sub-standard **DYNAMOMETER** type Moving Coil, 0-50 amps. Elliott **DYNAMOMETER** type 2-Coil Universal **VOLTMETER**, portable sub-standard; reading, 0-15 v. and 0-300 v. A.C. and D.C. Evershed Portable H.T. **VOLTMETER**, 0-1,500 v. D.C. Moving Coil, new. Elliott Moving Coil Switchboard **MILLI-AMMETER** 8in. dia. reading 0-2 m.a. N.C.S. **VOLTMETER** Moving Coil C.T., Portable, 6in. scale 1.5-0-1.5 volts and 150-0-150 volts. Ditto, ditto, single range, 0-300 volts. A Standard 300-ampere Shunt, res. .0005 ohm.

64in. dial, special open scale Siemens A.C. **VOLTMETER**, 600 v. Cambridge **PYROMETER**, meter only, 200 micro-amps. def. Silvertown Portable **TESTING SET**, with **GALVO**. **CAPACITY BRIDGE**, .00001 to 10 mfd., with oscillator box. Evershed Bridge **MEGGER**, 500 volts 40 megs, with 0 to 10,000 decade resistance. Evershed Bridge **MEGGER**, less res. 500 volts 40 megs. Evershed Direct Reading Capacity **MEGGER**, .005 to 1 mfd. Evershed **MEG**, mains type, 250 volts 20 megs., aluminium case. N.C.S. **OHMMER**, 500 volts ½ to 20 megs.

Weston Thermo **MILLI-AMMETER**, M.C. 0-125 m.a. Weston Central Zero **GALVO MICRO-AMMETER**. Turner 6in. dial Thermo **AMMETER**, 0-10 amps. Standard **INDUCTANCE**, .001 Henry in mahogany case, 2 ohms. Sullivan and other sub-standard Laboratory **CONDENSERS**, range to .0005 mfd. Standard **FIXED CONDENSERS**, 6in. brass case, top plug, Marconi Precision Laboratory **RES. BOX**, 1 to 110 ohms. G.P.O. Standard type **WHEATSTONE BRIDGE**, to 10,000 ohms; with Griffen Galvo. Wheatstone 6-dial H.R. Bridge, Paul type with **GALVO** in centre, polished mahogany case. Gambrell 10,000-ohm Plug type Wheatstone Bridge, with **GALVO** and N.P.L. Certificate. Brand new Griffen 30 Wheatstone Bridge and Weston Galvo/ Sub-divided Ohm Box in steps of .05 to 10 ohms. Several Unipivot **MICRO-AMMETERS**, various ranges:

Sullivan Lab. Standard Heterodyne **WAVEMETER**, with valve, 8 ranges and charts, 150 metres to 16-20 kilometres, with coupling coil; N.P.L. Standard. Gambrell Type "D" Buzzer pattern **WAVEMETER**, polished mahogany case, 8in. x 8in., range to 500 metres, with calibration charts. Sullivan **WAVEMETER**, aluminium case, 12in. x 6in., 300 to 16,000 metres, with calibration charts. **SPEECH TRANSMISSION** Test Bridge, Model MS225, by Western Electric, G.P.O. Model. Gold Leaf Electroscope, Portable type, 3in. dial. **ANEMOMETER**, 6-dial, Pocket type, reading 1 to 1,000,000 metres, by Stanley.

Moving Coil Relays, in 3in. x 4in. x 8in. brass case, make contact on ¼ m.a. Ditto, Weston make, in 3in. x 4in. x 8in. case, with window. A.C. Contactors, Remote Control type, enclosed, 250 v. 15 amps. Isenthal Voltage Regulator (Automatic). Siemens High-speed Relay. Sullivan Sensitive Relay Moving Coil, operates on a few micro-amps. A Tinsley-Anson Neon-valve Trigger Relay; list £12. Hill-Barnard **SPHYGMO-METER**, to 250 mHg.

Brand new Synchronophone, £28 Octocross, 16mm. mains, **PROJECTOR**, with 400ft. spool, lamp and motor. Several Sound Heads, complete with photo-films. Film Printing Machine, electrically driven, 110-volt D.C. motor, wooden cabinet, 27in. x 19in. x 10in., fitted sprockets and brackets for film spool, asbestos lined lamp-house and adjustable lamp bracket. Ensign 16mm. Kinécram Movie Camera, new in case, 16mm. Projector Ottway Camera, Gun type, long range, twin exposures on 35mm. film. Campro 35mm. Movie **CAMERA PROJECTOR**, suitcase type.

Write for Price List and full particulars
The cheapest House for Meters, Mikes & Switchgear.

ELECTRADIX RADIOS,
218, Upper Thames Street, London, E.C.4

Telephone: Central 4611.

Components, Etc., for Sale.—Contd.

(This advertisement continued from first column.)

SPECIAL Offer Manufacturers' Type Transformers, 350-0-350 100 m.a., 4v. 1a., 4v. 2a., 4v. 3-5a., 10/-; input 200-250 A.C.; 350-0-350 120 m.a., 4v. 2-3a., 4v. 2-4a., 100-120v. input only, 5/-.

WESTERN ELECTRIC Mains Transformers, 300-0-300v. 65 m.a., 4v. 1-2a., 4v. 2-3a., 8/6; 500-0-500v. 150 m.a., 4v. 3-5a., 4v. 2-3a., 4v. 2-3a., 4v. 1a., C.T., 4v. 1a. C.T., 19/6; 1,000-0-1,000v. 250 m.a., 4v. 3a. C.T., 4v. 3a. C.T., 49/6, 2,000-0-2,000 150 milliamps, 49/6.

PREMIER L.T. Charger Kits, consisting of Premier transformer and Westinghouse rectifier, input 200-250v. A.C., output 8v. 12 amp., 14/6; 8v. 1 amp., 17/6; 15v. 1 amp., 19/-; 6v. 2 amp., 27/6; 30v. 1 amp., 37/6, 2v. ½ amp., 11/-.

COLLARO Gram. Unit, consisting of A.C. motor, 200-250v. high quality pick-up and volume control, 49/-; without volume control, 46/-.

B.T.H. Trusped Induction Type (A.C. only) Electric Gramophone Motors, 100-250v.; 30/- complete.

B.T.H. Gramophone Motors, 100-250 volts A.C. or D.C., specially recommended for D.C., complete; 30/-.

EDISON Bell Double Spring Gramophone Motors, complete with turn-table and all fittings, a really sound job; 15/-.

SPECIAL Offer of Wire Wound Resistances, 4 watts, any value up to 50,000 ohms, 1/-; 8 watts, any value up to 15,000 ohms, 1/6; 15 watts, any value up to 50,000 ohms, 2/-; 25 watts, any value up to 50,000 ohms, 2/6.

WIRE Wound Potentiometers, 15,000 ohms, 1/6; 50,000 ohms, 2/-; 500,000 ohms, 3/-; 1,000 ohm wire wound semi variable resistances, carry 150 m.a., 2/-.

CENTRALAB Potentiometers, 50,000, 250,000, 1.2meg. any value, 2/-; 200 ohms, wire wound, 1/-.

POLAR Star, manufacturers' model, 3-gang condensers, fully screened, 7/6; with trimmers.

ORMOND and Polar All-brass 0.0005 Condensers, with knob dial, 2/-; with slow motion drive, 3/-.

AMERICAN Triple Gang 0.0005 Condensers, with trimmers, 4/11; Utility Bakelite 2-gang 0.0005 screened with uniknob trimmer, 3/8; Polar Bakelite condensers, complete with knob, 0.00015, 0.00035, 0.0003, 0.0005, 1/-.

ORMOND Condensers, 0.0005 2-gang semi-shielded, 2/6; brass vanes, with trimmers, 3/6.

MAGNAVOX D.C.152, 2,500 ohms, 17/6; D.C.154, 2,500 ohms, 12/6; D.C.152 Magna, 2,500 ohms, 37/6, all complete with humbucking coils; please state whether power or Pentode required; A.C. conversion kit for above types, 10/-; Magnavox P.M. 7in. cone, 18/6.

AMPLION Loud Speaker Units, 1/6; complete with 12in. cone and chassis, 3/11.

RELIABLE Canned Coils with Circuit, accurately matched, dual-range, 3/- per coil; ditto, iron cored, 3/6.

RELIABLE Intervalve Transformers, 2/-; Cyldon capacitors (double trimmers), 1/-; multi ratio output transformers, 4/6.

WESTERN ELECTRIC Condensers, 250v. working, 1 m.f., 6d.; 2 m.f., 1/-; 4 m.f., 2/-; 400v. working, 1 m.f., 1/-; 2 m.f., 1/6.

T.C.C. Electrolytic Condensers, 550v. working, 650v. peak, 8 m.f., 4/-; 4 m.f. or 8 m.f., 440v. working, 3/-; 15 m.f. 50v. working, 1/-; 25v. working, 25 m.f., 1/3; 6 m.f. 50v. working and 2 m.f. 100v. working, 6d.; 16-4 m.f. 250v. working, 8/6.

T.C.C. Condensers, 250v. working, 2 m.f., 1/9; 2 m.f. 1,500v. working, 6/-; 4 m.f. 1,500v. working, 10/-.

H.M.V. Condensers, 400v. working, 4x4x1x1x1x1x0.1 x0.1x0.1x0.1, 6/-; 4x2x1x1x1x0.5, 4/6.

DUBILIER Condensers, 2 mfd., 1,200v. working, 4/-; 8 mfd. dry electrolytic 450v. working, 3/-.

VARLEY Constant Square Peak Coils, band pass type BP.7, brand new in maker's carton with instructions and diagram, 2/6.

VARLEY H.F. Intervalve Coils BP.8, band pass, complete with instructions in original cartons, 2/6.

SCREENED H.F. Chokes by One of the Largest Manufacturers in the Country, 1/9.

PREMIER British-made Meters, moving iron, flush mounting, accurate, 0-10, 0-15, 0-100, 0-250 m.a., 0-1, 0-5 amps., all at 6/-.

LARGE Selection of Pedestal Table and Radiogram Cabinets, by best manufacturers, at a fraction of original cost, for cables.

THE Following Lines 6d. each, or 5/- per dozen.—Chassis valve holders, 5-, 6-, or 7-pin, screened screen grid leads; any value 1-watt wire end resistances, wire end condensers, 0.0001 to 0.1 trimming condensers, Bulgin 3-amp. mains switches.

PLEASE Send for Fully Illustrated Catalogue.

PREMIER SUPPLY STORES, 20, High St., Clapham, S.W.4. Telephone: Macaulay 2188. Nearest Station, Clapham North Underground. [6010]

GILBERT INDUSTRIES, Ltd.

PARCEL Containing 6 gross All Brass Screws, in useful B.A. wireless sizes such as 4 B.A. x 1in., 6 B.A. x ¾in., etc., etc.; they include round, cheese and countersunk heads, and with every parcel we include 1 gross assorted nuts free, 5/-; post paid.

GILBERT INDUSTRIES, Ltd., 519, London Rd., West-cliff-on-Sea, Essex. [5997]

WOBURN RADIO'S Clearance Sale:—

DUBILIER 2 mfd. Condensers, 500v. test, 1/2, 1,000v. test, 1/4; H.F. chokes, 9d.; binocular chokes, 1/-; chassis valve holders, 4-5-pin, 2½d.; tubular condensers, 0.01, 0.02, 5d.; Eston iron-cored coils, 2/3; Polymet 0.001 tag condensers, 2/-; dozen; Edison 0.02, 0.05, 0.06, 5d.; Radiophone straight-line drives, with escutcheon, 3/9; Radiophone toggles, 6d. on-off switches, 2-pt., 4d.; 3-pt. 5d.; A.T.F. 16/6; O.P.M. 3C, 12/6; Ferranti Class B unit, 25/-, with B.V.A. valve, 32/6; Colvern Ferrrocarts G1 and 3, with switch 26/6; Seradex resistors, 1½ watt, 100, 250, 350, 500, 750, 1,000, 1,500, 2,000, 2,500, 5,000, 7,500, 10,000, 15,000, 20,000, 25,000, 30,000, 40,000, 50,000 60,000, 75,000. 0.25, 0.5, 1 and 2 meg., 4½d. each; Westinghouse L.T.1 rectifiers 6v. 0.25 amp., 4/6; also 6v. 1 amp., 6/6.

W.R.C. Eliminators: 150v. at 30 m.a., 3 positive H.T. tappings, D.C. model, 9/9; at A.C. model, 21/-; A.C. model, with trickle charger, 32/6; all guaranteed 12 months (post 1/- extra).

LET US Quote for Kits and Components; trade enquiries invited.

WOBURN RADIO Co., 9, Sandland St., W.C.1. Holb 7289. [6022]

Components, Etc., for Sale.—Contd.

SOUTHERN RADIO'S Bargains.—Set manufacturer's guaranteed surplus. VARIABLE Condensers.—Lotus 3-gang 0.0005, 12/6; Lotus 2-gang, 0.0025, 8/6; Lotus Dyblock single, 0.0005, 4/9 (list 9/6); all these condensers are complete with dials, escutcheons, knobs, fully screened with trimmers, and boxed; Hydra block condensers, 16 mfd. (2+2+2+2+1+1), 1,000v. D.C., 7/- each; Dubilier 4 mfd. (2+1+1), 1,000v. D.C., 2/9; 4.5 mfd. (2.25+2.25), 1,000v., for mains noise suppression, 3/-; fixed 4 mfd., 2/5; 2 mfd., 1/6; 1 mfd., 1/-; Utility Midget 2-gang variable condensers, 0.0005, with concentric trimmers, 3/5; T.C.C. 0.1+0.1, 1/3 each. SPEAKERS.—Blue Spot permanent magnet, with universal transformer for power, super power, pentode and Class B; 25/- (list 39/6). G.E.C. Stork Speaker, in cabinet; 19/6 (list £3/15). BLUE Spot Genuine 100U Inductor Speaker on Chassis; 13/6 (list 39/6). S.T.400 Kits, all specified proprietary components; £2/19/6 (list £4/17/6). EKCO A.C. Eliminators, each new and boxed, in original sealed cartons, type K25, with trickle charger, 25 milliamps, 39/6 (list £5 7/6); type A.C.25, 33/6 (list £3/17/6); type K.12 with trickle charger, 37/- (list £3/17/6); Ekco trickle chargers, type T.C.I., for 2-4 and 6-volt accumulators, 20/- (list 42/-). IGRANIC Superhet Coils, set of 4 (1 Osc., 2 I.F. with pig tails, 1 I.F. plain); 12/6 (list 50/-). IGRANIC Band Pass 3 Coils Unit, iron-cored, screened on base, with switch; 14/- (list 33/-). LISSEN Superhet 3 Coils Unit, screened, ganged on base with wave change and filament switches; type L.N.5181, for battery or mains; 12/6 (list 30/-). VARLEY Constant Square Peak Coils, complete with all accessories, new, boxed, B.P.5; 2/4. VARLEY H.F. Inter-valve Coils B.P.6, 2/3. IGRANIC Tuning Unit, known as "Igranipak" brand new and complete with all accessories for A.C. mains; 27/- (list 57/6). VALVE Class B Superhet Chassis, made by Plessey, wired ready for use, with 5 Mullard valves, new, in sealed cartons; £3/17/6 complete (list £12/12); valves alone are priced £3. FRAME Aerials.—Lewcos dual wave superhet, 9/- each (list 27/6). PICK-UPS.—Marconi No. 19 (1934), 22/6 each (list 32/6); Celestion latest improved type W8 (1934), 16/9 (list 35/-); all new and boxed. READY Radio Instamat Transformers, for matching any valve to speaker; Junior model, ratios 1:2, 1:1, 1 1/2:1, 2:1, 3:1, 7/6 (list 27/6); Senior model, ratios 10:1, 12 1/2:1, 14:1, 16:1, 20:1, 25:1, 12/6 (list 37/6). RECEIVERS.—3-valve screen-grid Ejector Super, complete with valves, Exide batteries and accumulator, Celestion moving coil speaker, contained in magnificent walnut cabinet; £3/10 (list £10). OSRAM Thirty-Three Music Magnet, complete with G.E.C. speaker, two Osram screen-grid and Osram power valves in moulded bakelite-walnut cabinet; £3/12/6 (list £9/9); in original sealed cases. READY Radio Meteor Screen-grid 3-valve Kits, all specified components new, in sealed cartons; 25/- less valves; with 3 Mullard valves 42/6 (list £5 7/6). Kit as Above, complete with magnificent walnut cabinet and Celestion perm. mag. speaker; less valves, £3/5; with 3 Mullard valves, £4/2/6 (list £8/17/6). Cossor "Melody Maker" 3-valve A.C. Kit, model C "336", including cabinet, 4 Cossor valves (including rectifier), power unit, and all components; £4/17/6 (list £9/15); new in sealed cartons. MAINS Transformers.—Full list of mains transformers and chokes sent free. MISCELLANEOUS.—Rotorohm volume controls, all values, 3/- each, with switch, 3/3 (list 10/6); Westinghouse metal rectifiers, H.T. 6, 7, 8, 9/3 each; Ferranti inghouse 20 mfd 60 m.a., 6/9 each; Ready Radio L.F. transformers, 5-1, 3-1, 3/3 (list 8/6); Lewcos superhet 8-way bases, complete with valve holders, grid leak, fixed condenser type "48," 2/- each; Lissen base turntables, 1/6 (list 5/-); Lissen H.F. chokes, 1/6 (list 5/-); Lewcos coils, B.P.F./R., 4/-; T.B.F./C., 3/3; O.S.C./126 (Extensor), 3/3; T.O.S./R., 3/3. ALL Goods Guaranteed and Sent Carriage Paid; hundreds of other bargains in stock. BRANCHES at 271-275, High Rd., Willesden Green, N.W.10, and at 46, Lisle St., W.C.2. Please send all post orders to 325, Euston Rd., N.W.1. SOUTHERN RADIO, 523, Euston Rd., London, N.W.1 (near Warren St. Tube). Phone: Museum 6324. [5991] PEARL and PEARL Bargain List A Free—190, Bishopsgate, London, E.C.2. [0421] THE Following Unused Set Manufacturers' Surplus, all goods guaranteed perfect, immediate delivery. "FERROCART" Coils, G1, G2, G3, with switch, 27/6; G11, G12, G13, G14, with switch, 33/6; Colverdynes, 7/6; brand new Radiopaks, all types, 35/- DUBILIER Resistors, 1 watt type, 7d.; 2 watt type, 1/3; Marconi K19 pick-ups, 22/6. WESTINGHOUSE Rectifiers, H.T.8, 9/6; H.T.9, H.T.10, L.T.4, L.T.5, 10/9; transformers (Regentone) for H.T.8 or H.T.9, 4 amp. L.T., 7/6. TRANSFORMERS, 350-0-350V. 60 m.a., 4v. 4a., 4v. 2a., 12/6; A.C. and D.C. eliminators, first-class make, tappings, S.G., detector, power (150v. 25 m.a.), A.C. type with Westinghouse rectifier, 25/-; D.C. type, 12/- DUBILIER or T.C.C. Electrolytic Condensers, 8 mfd. or 4 mfd., 500v., 50v. 0.0 mid., 3/6; B.T.H. pick-up tone arms 3/-. CARRIAGE Paid, cash with order or c.o.d.; send for list. WARD, 2nd Floor, 45, Farringdon St., London, E.C.4. Telephone: Holborn 9703. [5724] UP-TO-DATE Components for Sale, cheap.—"Sunnyside," 56, Oaklands Av., West Wickham, Kent. [6044] FERRANTI A.F.15.C. Class B driver transformer, unused; 15/-, c.o.d.—Hayman, 8, Terrapin Rd., S.W.17. [6039] DEAL Direct with the Main Source of Supply and Save the Middlemen's Profits.—See Thompson's advert, on page 2. [6064] RADIOLAB Complete Valve and Set Tester, as new; £7/10, or near.—Smith, 128, Brighton Rd., South Croydon, Surrey. [6037]

Components, Etc., for Sale.—Contd.

UTILITY SALES Co. Offer the Following Surplus Goods, all new and boxed and fully guaranteed. CELESTION P.M.M.W. Speaker, list 45/-; 17/6. EKCO 1/2 amp. 2-4-6 volt L.T. Charger, list £27/6; 17/6; also A.C. 25, 31/6; K.25, 35/8. MAINS Transformers by Standard Cable Co., primary 200-240 secondary 0-0-500, 60 m.a., 4v. 3a. ct., 4v. 2a., very strongly recommended; 6/6. ALL Our Goods are Delivered Within 24 Hours—carriage paid. UTILITY SALES Co., 27a, Sale St., Paddington, London, W.2. [6058] MAINS RADIO DEVELOPMENT COMPANY Offer the Following New Lines; guaranteed surplus. EADY Radio, boxed spaghetti resistances, 10,000, 15,000, 20,000 25,000 ohms, 9d. per dozen. T.C.C. 0.5 mfd. condensers, 250v. working, no fixing lugs, 6d.; A.T.C., 0.1x0.1 mfd., 450v. working condensers, 10d.; Mikado 0.0005, 0.002 mfd. condensers, 1d. each. READY Radio, L.F. transformers, 3-1, new and boxed, 2/9; Lotus 0.00015 differential reactions, boxed; 10d. CABINETS, tasteful walnut, 16in.x11in.x6 1/2 in. back, speaker fret, 2/9; stamp for list of clearance lines. MAINS RADIO DEVELOPMENT COMPANY, 4-6, Muswell Hill Rd., London, N.6. Tudor 4046. [6034] BIRMINGHAM RADIO MART'S Special Summer Reductions; buy now and save money; "no junk." RADIOMART.—Single-span formers, 11in.x2in., seven for 10d.; 100 mmfd. micros, 1/3; get our list for other gear. RADIOMART.—Igranite smoothing chokes, 20-10hy., 260 ohms, 100 m.a., Stalloy core, impregnated interleaved windings; 2/9. RADIOMART.—Utility screened 2-gang 0.0005 super bakelite, fitted Uniknob trimming disc drive; 2/11. RADIOMART.—Magnum radiogramophone dissolvers, 2/9; A.L.D. ditto, 3/6; Igranite, 10/6; tapped pentode chokes, 3/11. RADIOMART.—Bargain offer: one dozen Bellinglee bakelite terminals, 5 gross assorted B.A. screws; 5/- RADIOMART.—B.T.H., P.A., and speaker field replacement resistances, 1,000, 1,070, 2,100 ohms, 100 m.a.; 1/- each. RADIOMART.—New boxed Telsen electrolytics, 500v. working, 4 or 6 mfd., 2/9; 8 mfd., 3/-; 6 mfd., 275v., 2/3. RADIOMART.—Genuine Electrad Royalty 50,000 potentiometers, 1/6; Dubilier 1 mfd., 500 vt., 10d. RADIOMART.—T.C.C. 440v. electrolytics, 3/-; Dubilier 4 mfd., 200v. dry, 1/6; Hellesen 435v., wet, 2/3. RADIOMART.—New Western Electric G.P.O. microphones, 2/9; Western supersensitive insets, 9d. RADIOMART.—Celestion special 37/6; 2,500, fitted universal (including push-pull) transformer, humbucker, 16/6; Magnavox D.C. 144 humbucker, pentode, 16/6. RADIOMART.—Lanchester, £4; super smoothed mains units, 200v., 40 m.a., Westinghouse rectified, £1. RADIOMART.—Slekton, 6/6; super screened coils, 180-2,300 metres, gang accurately with S.G.3 circuit, 3/3; pair, 5/9. RADIOMART.—Amplion special, 21/-; 4-pole units, tapped power and pentode, 4/9; Amplion portable type, 1/6. RADIOMART.—Dozen colour coded resistances wire wound, our assortment, 3/-; Igranite tapped pentode chokes, 5/11. RADIOMART.—Visual tuning meters (10 m.a.), exceptionally neat, 5/9; Government milliammeters, flush, moving coil, 10, 25, 50, and 100 m.a., 16/6. RADIOMART.—T.C.C. 250v. A.C. equivalent 400v. D.C. working, 4x4x4 (12 mfd.), 3/9; T.C.C., soiled, 1,500v.t., 2 mfd., 2/6; 4 mfd., 3/6. RADIOMART.—Wearite Midget 30 ohm potentiometer, the ideal hum-dimmer, 10d.; Lissen ditto, 8d. RADIOMART.—These are Chokes!! Igranite C.T. constant inductance, 20hy. at 150 m.a., 200 ohms weight, 8 lb., 16/6; 20hy. at 700 m.a., 140 ohms weight 12 lb., 22/6; listed 45/- and 80/- RADIOMART.—Igranite Igranitor Cassimount dual range coils, 3/6; Igranite stripped Midget 20hy. chokes, 1/6. RADIOMART.—Utility 1934 bakelite tuning and reaction condensers, 0.0005, 10d.; 0.0005, 8d.; 0.0002, 0.0001, 6d.; differentials, 0.0003, 1/6. RADIOMART.—Cadmium chassis 5-valve, 1/6; 4-valve chassis 1/-; postage 6d. extra. RADIOMART.—Radiophone straight line dials illuminate—ours have oxidised escutcheons, knob, 3/6. RADIOMART.—British Radiophone super 5,000, wire wound logarithmic potentiometers, 2/-; 15,000, with switch, 2/6. RADIOMART.—Igranite boxed nickel-core 3-1, 5-1 transformers; list 10/6, 3/11; Igranite, 8/6; parallel feed, 2/11. RADIOMART.—Phileo Class "B" driver transformers, boxed, 2/9; valve-holder, baseboard, 9d.; chassis-mount, 7d. RADIOMART.—T.C.C. 25 mfd. electrolytics (bias), 25v., 1/6; Radiophone valve screens, 4d. RADIOMART.—2 1/2 x 2 1/2 mfd., 1,000v., ideal suppression mains interference or straight 4 1/2 mfd.; 2/6. RADIOMART.—Telsen boxed differential condenser, with knob, 0.0001, 0.00015, 1/-; 0.0003, 0.00035, 1/3. RADIOMART.—Met-Vick boxed H.F. chokes, really efficient, 1/-; Utility snap switches, 9d. RADIOMART.—0.1x0.1 mfd., 450v. non-inductive, across primary, cures modulation hum, 1/- RADIOMART.—Colvern 5-watt wirewound potentiometers 2,500, 15,000, 1/6; Magnum 25,000, 1/9. RADIOMART.—GSN1, offers the following short-wave equipment, accredited Hammarlund agents. RADIOMARK.—Brown ribbed 1 1/2 in. x 2 in. glazed stand-off insulators, 6d.; Frequentite valve-holders, 9d. RADIOMART.—Super all-brass 0.0001 short-wave variable, pigtail, 1/9; half-amp. H.W. meters, 5/6. RADIOMART.—Raymart H.F.C. 10-100 metres, 9d.; Ormound loss microvariables, 1/9. RADIOMART.—Microvariables, 15, 40, 100 mmfd., 1/3; Utility neurovernia's, 1/3; 400 potentiometer, 6d. RADIOMART.—June list now ready; most comprehensive published; stamp essential; orders 6/-, post free. RADIOMART, The Square Dealers, 19, John Bright St., Birmingham. [6049] 10,000 Motors, suitable for trains, Meccano, motor boats, etc., 6 or 12 volts A.C. and D.C., new; 3/- each, postage 6d. extra; worth 15/-.—Plater, 92, Umfreville Rd., Harringay, N.4. [6057]

Components, Etc., for Sale.—Contd.

MILDMAY RADIO EXCHANGE Offers the Following sound and perfect; cash with order or c.o.d. EKCO Type R.G. 23 Radiograms, for D.C. mains only, listed 1933 list at £24/5; brand new, in sealed boxes as received from the makers, with valves, satin finished walnut cabinet, fitted with moving coil speaker and electric motor with automatic stop and start, separate radio and gramophone controls and provisions for external loud-speaker; limited number, £10 each. SPECIAL Offer of the "Twentieth Century" Valve and Set Tester, complete with all leads and full working instructions, no outside batteries required other than a 4-volt accumulator when testing emission of A.C. valves, a complete and universal tester that will do the work of an expensive instrument; offered at the price of 20/- each; listed 1934 list at £2/5. EKCO Mains Units. TYPE K12, suitable for sets of 1-3 valves having an output of 150 volts 12 m/amps, and incorporating a charger for 2-, 4- or 6-volt accumulators; listed at £3/1/6; our net price 37/-; A.C. 200/250-volt. TYPE A.C.25, output 150 volts 25 m/amps, having 4 tappings, 2 variable; listed at £3/17/6, 33/6 each, boxed. TYPE K25, as above but with charger for 2-, 4- or 6-volt accumulators; listed at £5/7/6, our price, new and boxed, 42/6 each, boxed. SPECIAL Offer Ultra Type 55 P.M. Moving Coil Loudspeakers, complete with output transformers and in sealed boxes; listed £4/10, our net price 35/- each. SPECIAL Offer Ready Radio S.T.400 Cabinets, in beautifully finished figured walnut, to take both set and speaker; being offered at 10/- each. LOTUS Remote Controls, complete relay for 2 rooms, comprising relay jacks and plugs with 24 yards of 4-strand cable, 8/6 each; listed at 30/-. LOTUS A.C. Mains All Power Units, giving H.T., L.T. and grid bias, complete and brand new, for mains of 200-250 volts 40-100 cycles; £1/17/6 each. SPECIAL Offer Ferranti Inductor Dynamic Speaker S Chassis, equal and, in fact, better than cheap moving coils; 20/- each. EKCO D.C. Mains All Power Unit, giving H.T., L.T. and grid bias, 4 H.T. tapping, for 200-250-volt mains, 50/-; ditto, for A.C., 50/- THE Above Post or Carriage Paid. PHONE Clissold 5601. OPEN All Day Thursday, closed all day Saturday. 24, Mildmay Grove, London, N.1. [5983] RADIO CLEARANCE Offers the Following Manufacturers' Surplus of Components at Bargain Prices. MAINS Transformers, input 200-250v., output 320-0-320 at 60 m.a., 4v. at 3 1/2 amps. C.T., 4v. at 2 1/2 amps C.T.; 8/6 each. MAINS Transformers, input 200-250v., output 320-0-320 at 70 m.a., 4v. at 6 1/2 amps. C.T., 4v. at 2 1/2 amps C.T., shrouded, terminal type; 10/6 each. MAINS Transformers, input 200-250v., output 320-0-320 at 70 m.a., 4v. at 4 1/2 amps. C.T., 4v. at 2 1/2 amps C.T., shrouded, terminal type; 9/6 each. COILS.—Set of Band Pass Coils for S.G.3 matched manufacturers type; 4/6 per set. COILS.—Set of coils for 5-valve superhet, matched set of 3, manufacturers' type; 4/6 per set. INTERMEDIATE Frequency Transformers, 110 kc/s; 3/- each. SWITCHES (Platform type) Suitable for Band Pass, medium, long and gram.; 2/- each. VOLUME Controls by G.E.C., 8,000 ohms, log wound with switch; 2/6 each. 8 mfd. Electrolytics by Dubilier, 500 volt peak; 2/6 each. 2 mfd. Condensers, by Wego, type G.B.; 1/6 each. REACTION Condensers, 0.0003, Polar; 1/- each. 3-GANG Condensers, Plessey, with 110 kc/s section, complete with drive, scale and knob for superhets.; 10/6 each. PARALLEL Feed Transformers, by well known manufacturer, ratio 6-1; 3/- each. ALL Lines Post Free in U.K. RADIO CLEARANCE, 94, High Holborn, W.C.1. Telephone: Holborn 4631. [5925] CHARGING Dynamos, 20v. 8a., 32/6; 50v. 5a., 35/-; 50v. 15a., 70/-; 100v. 3a., 45/-; resistances or shunt regulators, any capacity, 12/6.—Below. WALL Telephones.—Magneto calling, 12/6; pedestal telephones, 7/6; microphones, 1-, 2/6 and 4/6; hand telephones, 4/6; Morse keys, 2/6; buzzers, 2/-.—Below. FLEXIBLE Drives, transmit 1h.p., 2/6; 15in. Emery wheels, new, 7/6; 1 1/4hp. 110v. D.C. motors, 10/-; ditto, fitted water pump, 35/-; 1/4hp. 220v. D.C. motor, 30/-; large Verner time set circuit-breaker, fitted 28-day clock, new, 50/-.—Below. GALPIN, 75, High Rd., Lee, S.E.13, London. Cash with order or c.o.d. [6061] SCREENED Coils Will Give You Greater Selectivity; aluminium coil screens, with base, size 3 1/2 in. high, 2 1/2 in. diameter; price 1/6 each.—M.P.R., Ltd., Romford, Essex. [0428] NEWPORT SURPLUS STORES Offer Their Whole Stock at Less Than Cost Price; no reasonable offer refused for any component.—24a, Newport Court, Charing Cross Rd., W.C.2. [6047] R.K. Senior, D.C., 55/-; A.F.5.C., 17/6; both scarcely used; Celestion E.8 2,500 ohms, boxed, slightly soiled, 18/6; Marconi "Ideal" transformer, 5/6; J.B.S.L.I. dial, unused; 3/9.—Bateson, 13, Rochester Sq., N.W.1. [6042] LONDON'S Greatest and Oldest Surplus Clearance Depot; everyone's surplus requirements, no matter how small or large; we have them at the lowest price in the country; we defy competition.—Thompsons (Victoria), Ltd., 17, Strutton Ground, Westminster, S.W.1. [6031]

Components, Etc., for Sale.—Contd.

VAUXHALL.—Radiophone Radiopaks, only few left, hand-pass or R.F. superb, 117 kc/s or 110 kc/s, with Lucerne wavelength, station named scales, medium and long, complete with volume control; 32/6.

VAUXHALL Radiophone I.F. Transformers, with terminals, 6/-; Radiophone volume controls, with switch, all values, 3/6.

VAUXHALL.—Benjamin Class B driver transformers, ratios 1-1 and 1½-1, 6/6; Radiophone Class B, ratio 1-1, 10/-.

VAUXHALL.—Radiophone gramophone switches, 3/6; pick-ups, various clarion, etc., from 14/-; B.T.H. or Collaro gramophone motors, 32/6, with pick-up and volume control; £2/12 complete.

VAUXHALL.—Scales for Lissen Skyscrapers, Lucerne stations named and metres, 2/6 pair; Clix valve-holders, various condensers, resistors, etc.; send postcard for lists.

CASH with Order, post paid over 2/6; or c.o.d.; all goods unused manufacturers' surplus; guaranteed perfect.

VAUXHALL UTILITIES, 163a, Strand, W.C.2. Phone: Temple Bar 9338. [6007]

PIONEER RADIO Offers Ericsson 3-1 L.F. Transformers, list price 17/6, new and guaranteed; our price 2/3, post free U.K.; Varley Constant Square Peak Band-Pass Coils, type B.P.5, complete with switch, brand new, in maker's original carton, with full instructions and diagrams, list price 15/-; our price 2/4, post free U.K.; Polar 3-gang Star Minor Condenser with trimmer, brand new, list price 18/9, our price 7/- each, post free U.K.; Collaro Electric Gramo. Motor, A.C., 200-250, with pick-up and volume control, auto start and stop, brand new, listed at £4, our price 47/6, carriage paid; Celestion Energised M.C. Speaker, 2,500 ohms, model D.C. 2054, with universal transformer, list price £2/5, our price 12/6; bankrupt set manufacturers' stock.

PIONEER RADIO, Coptic St., London, W.C.1. Museum 9606. [0425]

ULTRA Panther Table Console Cabinets, magnificent walnut finish, 21½×17½×11in., price 13/6, post 1/6. Ultra Lynx pedestal cabinet, polished walnut finish, 33½×18½×10in., 22/6, post 2/-; metal chassis, 14½×6½in., 9d., post 6d.; 4-valve, drilled ready for use, 13½×9½in. ditto, 1/-, post 9d.; cadmium plated 4-valve chassis, 13½×9in., drilled ready for use, 2/- each, post 6d.; electric light and power check meters, 5, 10 and 20 amps., useful for keeping a separate check on all electricity used, earn their cost over and over again, listed £4, to clear, all in good working order, 4/6, post 1/3; accumulators, by well-known makers, a wonderful bargain, 2 volt 45 amps. 4/6, post 6d.; 2 volt 20 amp. 2/9, post 6d.; iron core dual wave coils 1/10, post 3d.; Morse tapping keys 2/6, post 6d.; Western Electric 1 mid. condensers, 4d. each, post 2d.; general purpose wire for aerials, earth and gardens, etc., 50/70 feet, 6d., post 4d.; watch pattern microphones 1/9, post 3d.; Burndep 2-valve a.c. sets, complete with speaker, Westinghouse rectified, 37/6 (less valves), post 1/6; Westinghouse L.T. rectifiers, 6 volt 1 amp. 6/6, post 6d.; ditto, 6 volt, ½ amp., 5/-, post 6d.; Westinghouse H.T.5 3/6, post 4d.; see also advertisement on page 2.—Thompson's (Victoria), Ltd., 17, Stratton Ground, Westminster, S.W.1. Telephone: Franklin 6355. [6069]

MISCELLANEOUS.

EVERYTHING for Movies.—Cameras and Projectors from 20/-; screens from 5/-.

ILLUSTRATE ENTERPRISES, 159, Wadour St., London, W.1 (facing Film House, Oxford St. end); not a shop, but a warehouse packed with motion-picture equipment; your inspection invited. Phone: 6889 Gerrard; free parking facilities. [5936]

DEAL Direct with the Main Source of Supply and Save the Middlemen's Profits.—See Thompson's advert. on page 2 [6065]

EMPLOYERS are Searching for Skilled Draughtsmen and First Class Engineers, all branches; our special postal training will make you suitable.—Dept. 92, The Bennett College, Ltd., Sheffield. [6068]

AMBITIOUS Men.—Qualify for a well paid post by studying at home with the T.I.G.B. Write to-day for "The Engineer's Guide to Success," 152 pages, free, which contains the widest selection of engineering and wireless courses in the world, and shows you how to become A.M.I.E.E., A.M.I.Mech.E., A.Rad.A., etc. State branch, post or qualification that interests you.—The Technological Institute of Great Britain, 82, Temple Bar House, London, E.C.4. (Founded 1917. 19,000 successes.) [6029]

PATENT AND TRADE MARK AGENTS.

A. MATHISEN, Chartered Patent Agent; patents, designs and trade marks.—First Avenue House, High Holborn, London, W.C.1. Holborn 8950. [5284]

GEE and Co. (H. T. P. Gee, Patent Agent for Great Britain, U.S.A., Canada, etc., Mem. R.S.G.B. A.M.I.R.E.), 51-52, Chancery Lane, London, W.C.2 (2 doors from Government Patent Office). Phone: Holborn 1525. Handbook free. [0001]

REPAIRS.

METROPOLITAN RADIO SERVICE Co., for car radio, installation and service.

REPAIRS to all British and American Receivers, American valves (all midget types), transformers re-wound.—Metropolitan Radio Service Co., 1021, Finchley Rd., Golders Green, London. Speedwell 3000. [5995]

MAINS Transformers Rewound; prompt service; satisfaction guaranteed; prices on request.—The Sturdy Electric Co., Wesley Terrace, Dipton, Newcastle-on-Tyne. [5992]

HENRY FORD RADIO, leading service specialists for H. American receivers, also British, trade work particularly; estimates free.—56, Howland St., Tottenham Court Rd., W.1. Museum 5675. [0434]

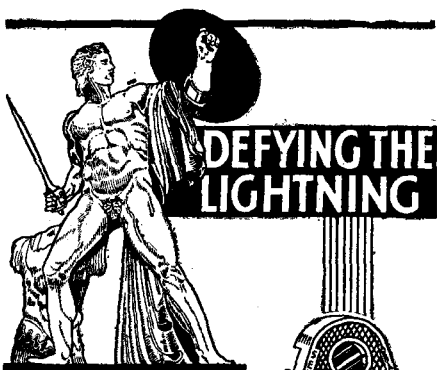

DEFYING THE LIGHTNING

ACHILLES & AJAX

both heroes of the Trojan war on the Greek side had, according to ancient legends a wonderful contempt for the forces of nature. They each are accredited with having "Defied the Lightning."

Thunderstorms need have no terrors for you if you fit the Bulgin Snap - Action Lightning Switch. Complete Protection can only be secured by the combined use of a FUSE, a SWITCH and a SPARK-GAP. All are included in this switch. **FREE £100 INSURANCE**



A. F. BULGIN & CO., LTD. ABBEY ROAD, BARKING, ESSEX.

SEND FOR THE BULGIN 80-PAGE CATALOGUE No. 153 "W." Enclose 2d. Postage.

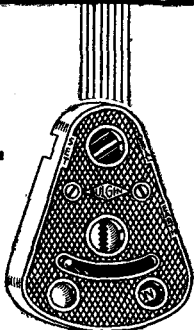

LIST NO 599
2/6
EACH

FOR PUBLIC ADDRESS WORK IN LARGE HALLS OR IN THE OPEN AIR

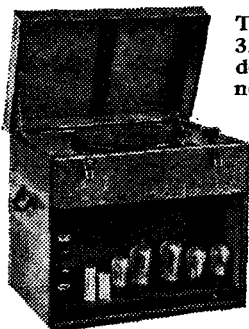

This amplifier (type 322) has been specially designed to meet the needs of clubs, political organisations, societies, etc. With an undistorted output of approximately 22 watts, its performance leaves nothing to be desired both in accuracy of tone and ability to handle large volumes. The 322 is

an all-purpose equipment as efficient as it is adaptable. Price, complete with gramophone motor and pick-up in stout oak case and Savage mike on short stand - **£40**

Send to-day for particulars of this and other Savage Amplifiers.

SAVAGE SOUND SYSTEM

W. BRYAN SAVAGE, 56/58, CLERKENWELL ROAD, E.C.1.

Repairs.—Contd.

OLD Sets Transformed to All Mains Universal A.C. D.C. with New High Voltage Valves, powerful, clear, hum-free reception guaranteed; prices 10/- per socket, plus price of valves; no extra parts charged for.—Sablons Radio, 69, Sister's Ave., London, S.W.11. [5837]

REPAIRS to Moving Coil Speakers, cones and coils fitted or rewound. Eliminators and transformers quoted for. Loudspeakers, l.f. and speech transformers, 4/- each. Post free. Trade invited. Satisfaction guaranteed. Prompt service.—Loud-speaker Repair Works, 5, Balham Grove, London, S.W.12. Battersea 1321. [0394]

TUITION.

YOUTHS trained for all branches wireless profession. Britain's leading college. Training fee payable after appointment. Students boarded. London representative for interviews. Prospectus free.—Wireless College, Colwyn Bay. [0388]

ELECTRIC CLOCKS.

SPECIAL Offer.—Superior A.C. main electric clock movements, 200-250v, 50 cycles, drive up to 10-inch hands; 16/6, post 6d.—Write details, Ebury Bridge Radio Co., 33, Ebury Bridge Rd. Sloane 8407. [5963]

EXCHANGE.

A STUNNING Allowances Made for Components and Receivers in Part Exchange for new goods, large selection of second-hand sets and components always in stock.—Zenith Radio Service, 17, Park St., Guildford. [0423]

DEAL With the Firm that Gives You the Highest Possible Allowance in Exchange, sets or components; prompt attention and deliveries.—Mildmay Radio Exchange. Phone: Clissold 5001. 24, Mildmay Grove, London, N.1. [5985]

EXTENDED PAYMENTS.

EASY PAYMENTS.—We supply you direct, by easy payments, components, accessories, and sets, any make; 10% down, balance spread over 12 months; any radio goods ordered c.o.d. despatched same day.—Send list of requirements to London Radio Supply Co. (established 1925), 11, Oat Lane, London, E.C.2. [0337]

FINANCIAL PARTNERSHIPS.

WIRELESS Engineer Required to Design and Control Manufacture; moderate investment.—Box 863, c/o The Wireless World [6040]

ACTIVE Partnership Desired in Established Extending Radio Business; capital £200; first class commercial experience.—Box 862, c/o The Wireless World. [6045]

WANTED.

WANTED.—Back issues *Radio News*, *Radio-craft*.—Box 850, c/o The Wireless World. [6030]

SPOT Cash for New or Used Modern Components.—Economic Radio Co., 96-98, South Lambeth Rd., S.W.8. [5964]

WANTED, good class radio components, sets, meters, speakers, etc.; spot cash paid; bring or send to North London Radio Service, 64, Hampstead Rd., N.W.1. [6060]

SET Analyser Wanted.—Preferably with valve oscillator or separate, must be good make and first class condition; full particulars and price to Box 843, c/o The Wireless World. [6028]

HIGH-CLASS Radio Parts and Sets Wanted for Cash, new or second-hand, any quantity, we pay up to one-third of the retail value for class goods; send yours, stating reasonable price; cash by return (no junk, please); dealers' obsolete stocks also purchased, any amount; van and representative will call for any reasonable lots.—Mildmay Radio Exchange, 24, Mildmay Grove, London, N.1. Phone: Clissold 5001. [5984]

SITUATIONS VACANT.

RADIO Engineers Required, with sound electrical and radio training, and with previous experience on test apparatus and cathode ray oscillograph design and construction.

WRITE, stating age, experience, and salary required, to Box 861, c/o The Wireless World. [6056]

VACANCY on Staff of Permanent Magnet Department for a Technical and Designing Engineer, preference given to applicants with experience in design of loud speakers and full knowledge of permanent magnet applications; apply in writing, giving full particulars of qualifications, age and salary required, to James Neill and Co. (Sheffield), Ltd., Napier St., Sheffield. [6027]

SITUATIONS WANTED.

YOUNG Man, with private connection in Middlesex and Surrey, would represent good firm, sales, installations, and most repairs; own equipment and car.—Box 860, c/o The Wireless World. [6055]

CRANLEY SINGLE-SPAN COILS
52/6 per set of Seven.
Wired and Assembled Complete with Condensers, and Can^s as specified, and Micro Dial. Coils only, per set of 7, 12/6.
W.W. Single-Span Transformer, 35/-, 10 hry. Choke, 12/6
W.W. Q.A. Amplifier Transformer, 57/6.
W.W. Multi Ratio Output Transformer, 50/-.
TRADE SUPPLIED.
CRANLEY RADIO LTD., 32, Craven Park Road, Harlesden, N.W.10 Phone: Willesden 3473.

INDEX TO ADVERTISEMENTS.

PAGE	PAGE	PAGE
Ardente	Columbia Graphophone Co., Ltd.	Ostar-Ganz (Eugen J. Forbat)
Automatic Coil Winder & Electrical Equipment Co., Ltd. Front Cover	Cranley Radio, Ltd. 7	Peto-Scott Co., Ltd. 3
Baker "Selhurst" Radio	Dubilier Condenser Co. (1925), Ltd. Back Cover	Philco Radio Corporation, Ltd. 4
Barber & Colman, Ltd. 3	Earl Manufacturing Co., Ltd.	Pitco, Ltd.
Baxter, Stavridi & Craies, Ltd. Inside Back Cover	Edison Swan Electric Co., Ltd.	Player's
Benjamin Electric Co., Ltd. iii	Electradix Radios	Rothermel, R. A., Ltd.
Berriman, E. M. 4	Ever Ready Co. (Great Britain), Ltd.	Savage, W. Bryan
British Blue Spot Co., Ltd.	Fel-Ectric Radiy	Shaftesbury Supplies
British Institute of Eng. Technology	Ferranti, Ltd. Front Cover	Tannoy Products
British Insulated Cables, Ltd. Inside Back Cover	Hartley-Turner Radio, Ltd. 4	Telegraph Condenser Co., Ltd. Inside Front Cover
British Mairs Unit Co.	Heayberd, F. C., & Co.	Telsen Electric Co., Ltd. Front Cover
British Pix Co., Ltd.	Henley's, W. T., Telegraph Works, Co., Ltd. 2	Thompson's (Victoria) Ltd. 2
British Rola Co., Ltd. 1	Institute of Wireless Technology	Ward & Goldstone, Ltd.
Bulgin, A. F., & Co., Ltd. 7	Lectro Linx, Ltd. 2	Westinghouse Brake & Saxby Signal Co., Ltd. Inside Back Cover
Burne-Jones & Co., Ltd.	London Radio Supply Co.	Wingrove & Rogers, Ltd. (Polar) i
Burton, C. F. & H., Ltd. Front Cover	Lyons, Claude, Ltd.	Wright & Weaire Ltd. iii
Bryce, W. Andrew, & Co.	Mains Power Radio Ltd.	362 Radio Valve Co., Ltd.
Cabaret Electric Co., Ltd.	National Institute of Radio Engineering	
Celestion, Ltd.		
City Accumulator Co., Ltd. 2		

<p>OSTAR-GANZ UNIVERSAL</p> <p>BUILD UP YOUR SINGLE SPAN WITH HIGH VOLTAGE VALVES</p> <p>Ostar-Ganz H.F. Pentode and Pentagrid Valves are the Valves you need to build the most up-to-date sets. Instructions free. Ostar-Ganz Valves are all made on the famous Universal High Voltage System with indirectly heated Cathodes. No Mains Transformers, Barretters or Cut-down Resistances, as required with any other type.</p> <p>UNIVERSAL KITS for the Home Constructor. With full size lay-out and instructions which enable Amateurs to build the most up-to-date sets to entire satisfaction.</p> <table border="0" style="width: 100%;"> <tr> <td>Universal Highmu 3</td> <td>£8 0 0</td> <td>Universal 5-Valve Super Radiogram</td> <td>£15 15 0</td> </tr> <tr> <td>" 4</td> <td>8 10 0</td> <td>" Highmu 4-Valve Radiogram</td> <td>12 12 0</td> </tr> <tr> <td>" 5-Valve Super</td> <td>11 11 0</td> <td>" Amplifier, 4-5 watt output</td> <td>5 5 0</td> </tr> <tr> <td>" 8-Valve Super</td> <td>18 18 0</td> <td>" 8-3</td> <td>8 8 0</td> </tr> </table> <p>E. J. FORBAT, 28/29, Southampton St., Strand, W.C.2. 'Phone: Temple Bar 8608</p>	Universal Highmu 3	£8 0 0	Universal 5-Valve Super Radiogram	£15 15 0	" 4	8 10 0	" Highmu 4-Valve Radiogram	12 12 0	" 5-Valve Super	11 11 0	" Amplifier, 4-5 watt output	5 5 0	" 8-Valve Super	18 18 0	" 8-3	8 8 0	<p>WE CLAIM THAT</p> <p>our Universal AC/DC sets fitted with the latest type Ostar-Ganz Universal High Voltage Valves are the most up-to-date receivers on the markets.</p> <p>ALL-WAVES-ALL-MAINS-ALL-ELECTRIC</p> <p>Receivers and Amplifiers.</p> <p>Our Receivers also supplied in CHASSIS form, thus making it possible to fit into your own cabinet and use your own speaker.</p> <p>Also at little cost WE UNDERTAKE TO CONVERT any type and any make of set to a most up-to-date and Powerful All-Mains Receiver with the famous Ostar-Ganz Universal High Voltage Valves.</p> <p><i>For full details and terms apply to:</i></p> <p>UNIVERSAL HIGH VOLTAGE RADIO Ltd., 28-29, Southampton St., Strand, London, W.C.2</p>	<p>Temple Bar 4985.</p>
Universal Highmu 3	£8 0 0	Universal 5-Valve Super Radiogram	£15 15 0															
" 4	8 10 0	" Highmu 4-Valve Radiogram	12 12 0															
" 5-Valve Super	11 11 0	" Amplifier, 4-5 watt output	5 5 0															
" 8-Valve Super	18 18 0	" 8-3	8 8 0															

The First Aero Weekly in the World

"FLIGHT" is the recognised leading authority on aviation. Sections are devoted to:

Private Flying, Work of the Clubs and Schools, Commercial Aviation, Airlines and Airports, Royal Air Force news, The Work of R.A.F. squadrons.

A special staff of highly competent aerial photographers ensures that "Flight" contains the finest photographs of aviation in all its aspects.

Illustrated descriptions of new aircraft, aero engines and equipment, British and Foreign, appear regularly, as well as helpful articles giving the latest information for Club members and amateur pilots.

"Flight" is the official organ of the Royal Aero Club of the United Kingdom.



EVERY THURSDAY 6D.

From all Newsagents and Bookstalls

Subscription

British Isles - - - - 33/-
Other Countries - - - - 35/-

FLIGHT
The AIRCRAFT ENGINEER AND AIRSHIPS

FLIGHT PUBLISHING CO. LTD., DORSET HOUSE, STAMFORD ST., LONDON, S.E.1

W.W.11

Printed in England for the Publishers, LIPFEE & SONS LTD., Dorset House, Stamford Street, London, S.E.1. by The Cornwall Press Ltd., Paris Garden, Stamford Street, London, S.E.1. "The Wireless World" can be obtained abroad from the following: UNITED STATES: The International News Co., New York. FRANCE: W. H. Smith & Son, 248, Rue Rivoli, Paris; Hachette et Cie, Rue Réaumur, Paris. BELGIUM: W. H. Smith & Son, 71-75, Boulevard Adolphe Max, Brussels. AUSTRALIA: Gordon and Gotch, Ltd., Melbourne (Victoria), Sydney (N.S.W.), Brisbane (Queensland), Adelaide (S.A.), Perth (W.A.) and Launceston (Tasmania). NEW ZEALAND: Gordon and Gotch, Ltd., Wellington, Auckland, Christchurch and Dunedin. INDIA: A. H. Wheeler & Co., Bombay, Allahabad and Calcutta. CANADA: Imperial News Co., Toronto, Montreal and Winnipeg; Benjamin News Co., Vancouver; Gordon and Gotch, Ltd., 132, Bay Street, Toronto. SOUTH AFRICA: Central News Agency, Ltd.



THIS SIGN . . .

in the theoretical diagram of a receiver means that a Westinghouse Metal Rectifier is incorporated. But, to those who look further than mere theory, it means much more . . . a constant undeteriorating high tension supply, with no replacements or renewals. It stands for reliability . . . which is just another way of saying



METAL RECTIFIERS

The Westinghouse Brake and Saxby Signal Co., Ltd.,
82, York Road, King's Cross, London, N.1.

COUPON
Please send me 44-page text book "The All Metal Way, 1934" relating to Westinghouse Metal Rectifiers and their uses. I enclose 3d. in stamps.

Name.....
Address.....
W.W. 6734

B.I. RESINKOR SOLDER AND CORALINE PASTE

are two aids to efficient soldering. B.I. "Resinkor" Solder is a solder with just the right quantity of resin embedded in it. It is invaluable for the soldering of electrical connections, particularly on fine work. "Resinkor" can be supplied in coils, on reels, or in cut lengths as required, in all diameters down to 20 s.w.g. B.I. Coraline Soldering Paste is suitable for copper, brass, tin, iron and lead and for electrical connections except the jointing of paper insulated cables. It is quite easy to apply, even in the most awkward corners, and once having been applied it does not run off the work, nor does it dry. It gives off no spray and is very economical.
Supplied in 1-oz., 2-oz., ¼-lb., ½-lb., 1-lb. and 7-lb. tins.

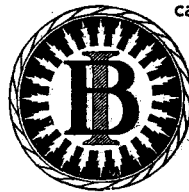

BRITISH INSULATED CABLES LTD.
Cable Makers and Electrical Engineers
PRESCOT, LANCS.
Telephone No. PRESCOT 6571.
London Office: **SURREY HOUSE, EMBANKMENT, W.C.2**
Telephone No. Temple Bar 4793, 4, 5 & 6.

NOW ON SALE!

RADIO RECEIVER MEASUREMENTS

By Roy M. Barnard, B.Sc., A.M.R.E.

Although primarily designed for the benefit of the radio service engineer, this concise handbook is also of practical value to the amateur experimenter.

It describes the methods of measuring receiver performance and provides provisional standards as a basis for judging performance. Measurements of sensitivity, selectivity and fidelity are explained at length and the interpretation in estimating receiver performance is carefully set out.

Details are given of up-to-date methods of receiver testing with full descriptions of commercial signal generators and their application to the adjustment of modern superheterodynes and "straight" receivers.

Complete with fifty-three illustrations and diagrams, summaries of method, four appendices and a general index.

PRICE 4/6 net
By post 4/9

From all booksellers or direct from the Publishers.

ILIFFE & SONS LTD., DORSET HOUSE, STAMFORD STREET LONDON, S.E.1
W.W.19



AND HAVE THE BEST RADIO-GRAMPHONE

In these days the ordinary radiogram quickly becomes obsolete. The Apollo-bureau playing desk is always up-to-date. Plus a good set it costs about £3 less than a radiogram, and it has storage for 80 records, scoring in convenience as well as economy. It is a beautiful job in finely polished walnut. With latest silent running Garrard induction motor and Goldring weight-adjusted pick-up as standard.



APOLLO BUREAU PLAYING DESK £5.19.6

Any other motor or pick-up fitted by arrangement. Cabinet only, £2.10.0. Complete, 12 monthly payments of 11/-. Order direct or through dealer or write for further details.

BAXTER STAVRIDI & CRAIES Ltd
4, BUNHILL ROW, LONDON, E.C.1.

OUTSTANDING RESISTANCES

Special quotations to Set Manufacturers and Industrial users.

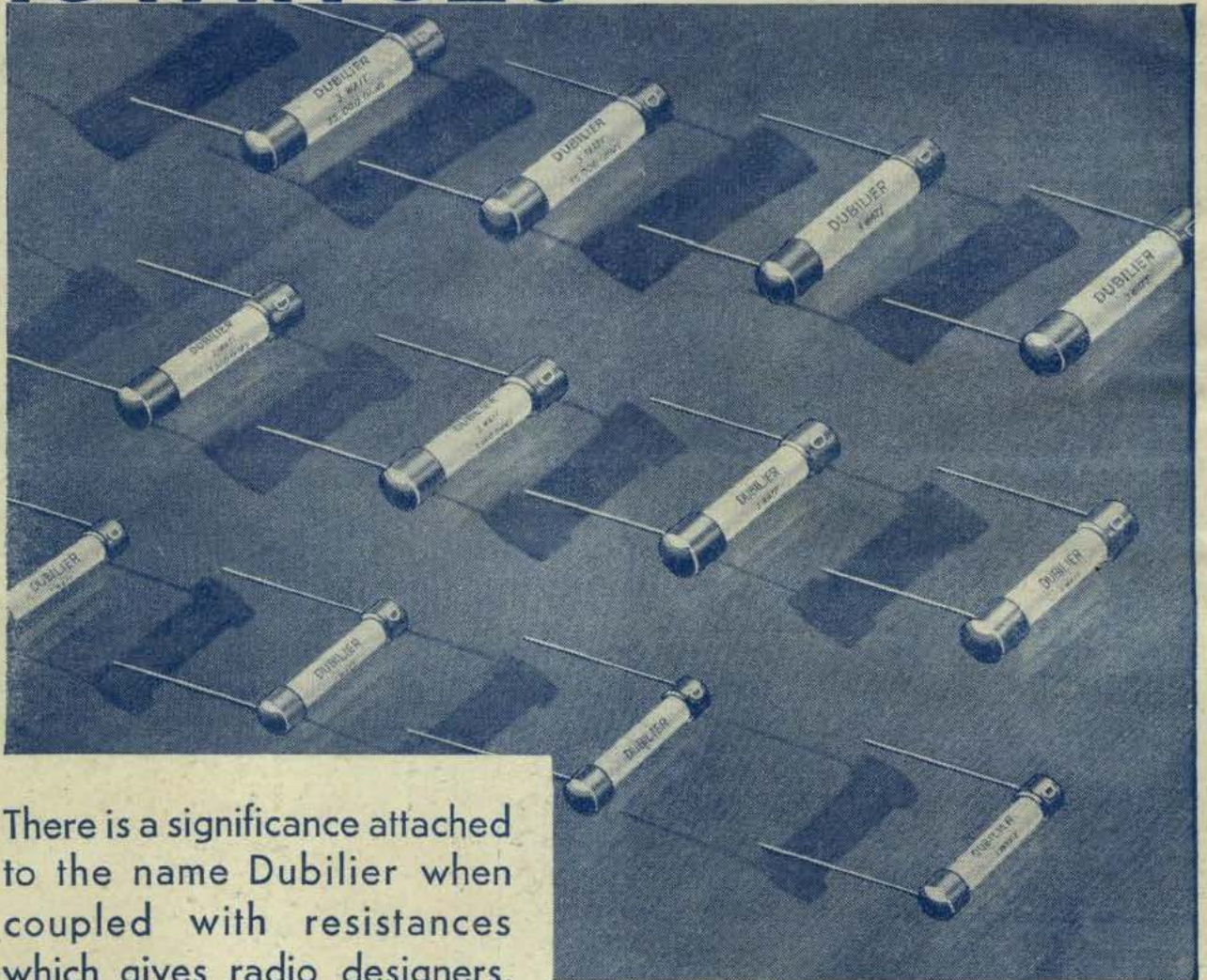

There is a significance attached to the name Dubilier when coupled with resistances which gives radio designers, manufacturers and constructors the confidence they have sought for years, and the assurance of utmost reliability. Dubilier—the 100% British Resistances—have an unrivalled reputation for reliability. They assure trouble-free reception to the listener and a minimum of servicing to the manufacturer, yet cost no more than others.

One Watt 1/-

Two Watt 2/-

Three Watt 3/-

DUBILIER RESISTANCES

DUBILIER CONDENSER CO. (1925) LTD., DUCON WORKS, VICTORIA ROAD, NORTH ACTON, W.3.

The Wireless World

4^D

THE PRACTICAL RADIO JOURNAL

with

Complete Foreign Programmes

Friday, July 13th, 1934.

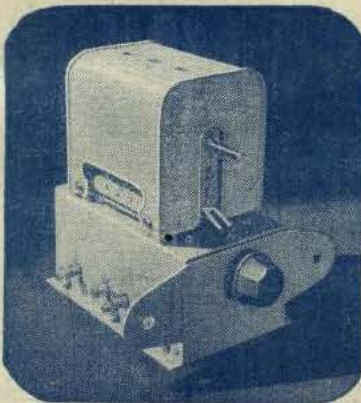

The most compact, efficient tuning unit of all

Like all Colvern products, the "Colpak" is built to a very high standard of engineering precision, and as it incorporates Ferrocart Coils, the utmost degree of selectivity and sensitivity is ensured. Every "Colpak" unit is carefully tested and ideally matched. Specify a "Colpak" for your set. Type "V" (illustrated)

62/6.

Made under licence from patents—Hans Yogi.

COLPAK FERROCART TUNING UNIT

You can depend on

COLVERN

COLVERN, LTD., ROMFORD, ESSEX. London Depot: 180, King's Cross Rd., W.C.1.

RADIOPHONE for RELIABILITY - a Component for Every Need

Complete Range of VOLUME CONTROLS

from 4/-

and

Q.M.B. SWITCHES

from 1/3

There is nothing to equal Radiophone for Quality and Lasting Efficiency.

BRITISH RADIOPHONE LTD., ALDWYCH HOUSE, LONDON, W.C.2.

TELSEN D.R. TRANSFORMER

—the L.F. Transformer with a STRAIGHT LINE



CHARACTERISTIC

which gives UNIFORM AMPLIFICATION over the entire range of audio-frequencies. The spaced layer windings are impregnated with a non-hygroscopic material of very low specific inductive capacity which absolutely eliminates all possibility of shorted turns or breakdowns due to large magnetic surges

D.R.3 (ratio 3-1)
D.R.5 (ratio 5-1)

8/6

Announcement of the Telsen Electric Co., Ltd., Aston, Birmingham.

TELSEN FOR EVERYTHING IN RADIO

WHATEVER THE RECEIVER

USE

T.C.C.
ALL-BRITISH
CONDENSERS

AND BE SURE



The Telegraph Condenser Co., Ltd., Wales Farm Road, N. Acton, London, W.3

Your BATTERY SET

can give you

"MAINS" VOLUME

without extravagant H.T. consumption

COSSOR CLASS "B" VALVES



KINGS OF THE AIR

COSSOR 240 B.

Filament volts 2.0; Filament amps 0.4; Anode volts 150 max; Max. Anode Current Swing 50 mA.; Max. Peak Applied Signal (Grid to Grid) 40 volts; Static Anode Current at $V_a=100$, $V_g=0$ (each half) 1.5 mA.

Price **14/-**

COSSOR 220 B.

Filament volts 2.0; Filament amp. 0.2; Normal Anode volts 120; Max. Anode Current Swing 35 mA.; Max. Peak Applied Signal (Grid to Grid) 40 volts; Static Anode Current at $V_a=100$, $V_g=0$ (each half) 1.25 mA.

Price **14/-**

By fitting a Class "B" Output Stage you can convert your present Battery Set into an up-to-date Receiver. The conversion is not difficult and, by using a Cossor Class "B" Valve, you will be able to obtain "mains volume" with little, if any, increase in H.T. consumption. Full details of this remarkable system of L.F. amplification will be sent you if you return the coupon below.

FREE! 72-page WIRELESS BOOK

From cover to cover this Cossor 72-page Wireless Book is packed full of useful and interesting information—latest circuits—explanations of technical terms—how a superhet works, etc. Send at once for free copy. Please use the coupon.

USE THIS COUPON



To A. C. COSSOR LTD., Melody Dept., Highbury Grove, London, N.5.

Please send me free of charge, a copy of Booklet B.21 which gives full details of Class "B" Amplification and include also a copy of the Cossor 72-page Wireless Book.

Name

Address

W.W. 13/7/34.

B.21 & B.V.33

5222

The Wireless World

THE
PRACTICAL RADIO
JOURNAL
24th Year of Publication

No. 776.

FRIDAY, JULY 13TH, 1934.

VOL. XXXV. No. 2.

Proprietors: ILIFFE & SONS LTD.

Editor:
HUGH S. POCOCK.

Editorial,
Advertising and Publishing Offices:
DORSET HOUSE, STAMFORD STREET,
LONDON, S.E.1.

Telephone: Hop 3333 (50 lines).
Telegrams: "Ethaworld, Watloo, London."

COVENTRY: Hertford Street.

Telegrams: "Cyclist, Coventry." Telephone: 5210 Coventry.

BIRMINGHAM:

Guildhall Buildings, Navigation Street, 2.
Telegrams: "Autopress, Birmingham." Telephone: 2970 Midland (3 lines).

MANCHESTER: 260, Deansgate, 3.

Telegrams: "Iliffe, Manchester." Telephone: Blackfriars 4412 (4 lines).

GLASGOW: 26B, Renfield Street, C.2.

Telegrams: "Iliffe, Glasgow." Telephone: Central 4857.

PUBLISHED WEEKLY. ENTERED AS SECOND
CLASS MATTER AT NEW YORK, N.Y.

Subscription Rates:

Home, £1 1s. 8d.; Canada, £1 1s. 8d.; other
countries, £1 3s. 10d. per annum.

*As many of the circuits and apparatus described in these
pages are covered by patents, readers are advised, before
making use of them, to satisfy themselves that they would
not be infringing patents.*

CONTENTS

	Page
<i>Editorial Comments</i>	17
<i>Universal Single-Span Receiver</i> ..	18
<i>Home-Made Signals</i>	21
<i>Broadcasting Under Hiller</i>	22
<i>Broadcast Distribution (Concluded)</i>	24
<i>New Apparatus Reviewed</i>	27
<i>News of the Week</i>	28
FOREIGN PROGRAMME	
SUPPLEMENT, pp. I—XXIV	
<i>Broadcast Brevities</i>	29
<i>Readers' Problems</i>	30
<i>Sunbeam "Midget," Model 22</i> ..	31
<i>Letters to the Editor</i>	32

EDITORIAL COMMENT

Transmitter Distribution and Quality

Power in Relation to Number of Stations

AFTER a succession of international conferences on broadcast station distribution in Europe, the position at last shows some signs of stability. We do not hear so much as in the past of new stations opening up and causing heterodyne interference with transmitters already established. Big increases in power are, however, still taking place and threatening to cause permanent daylight as well as night interference, because their daylight range is now so much greater, so that, although some agreement seems to have been reached with regard to limiting the number of stations, these increases in power are creating a new problem.

It would seem possible that some formula might be arrived at whereby increases in power of stations in kilowatts in any country might be related to the total number of channels allotted, and, where substantial increases in the power of one or two stations takes place, some sacrifice in channels occupied by stations of lesser power should be made by the country concerned. If, for example, the power of a transmitter is increased by 30 kilowatts, then a channel occupied by a 5 or 10 kilowatt station should be given up.

Quality should be the aim of all the broadcasting authorities of Europe as the first consideration after an adequate service to cover each country has been established, and it would seem that the surest way by which a wider transmission frequency can be brought about so as to improve quality, would be by reducing the number of stations so that the separation can be greater,

even though the power of the remaining stations were increased.

Several manufacturers of receivers in this country are now discussing in their publicity literature the merits of higher quality reproduction, and this new attitude should be encouraged in every possible way.

Some Continental countries have not yet begun to appreciate the importance of quality and are satisfied with a restricted frequency band, but we may expect that this state of affairs will gradually be remedied, and it is surely up to this country to lead the way in the campaign for better quality.

No Name

Makers Should Label Their Sets

IT is interesting to note that an increasing number of the new receivers bear the maker's name in some suitable style on the cabinet. We have often wondered in the past why it was that so many manufacturers appeared to prefer that their products should go out to the public anonymously, or at least, identifiable only if a trade mark is recognised.

In the course of our contact with readers, we have constantly found that owners of sets who have come to us for advice about them have been unable to tell us the make, because the cabinet carried no indication of the origin of the set. It is understandable in some instances that a manufacturer might not be proud enough of his product to label it, but in the case of manufacturers of repute every set sold should act as a permanent advertisement, so that the owner's friends, when they have been duly impressed with the performance, will make a note of the manufacturer's name for their own guidance when choosing a new receiver.

The Universal Single-Span Receiver

Constructing and Adjusting the New Set

By W. T. COCKING

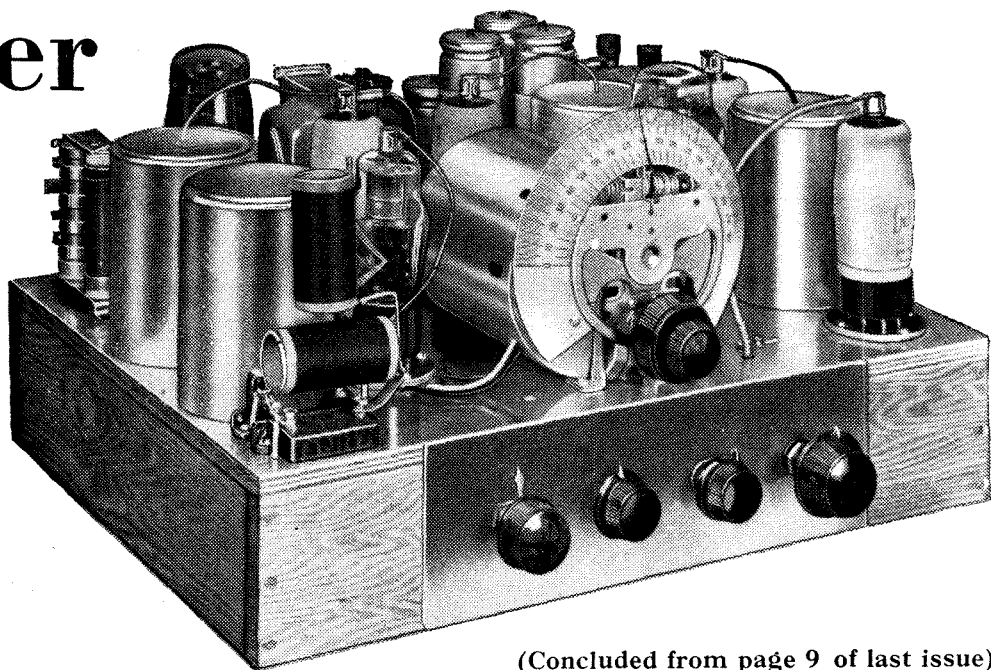

(Concluded from page 9 of last issue)

BOTH the receiver and the mains equipment are assembled on a single chassis built from metal-covered plywood, for a two-unit construction gives little advantage in the case of a "Universal" receiver. The assembly of the various components on the chassis is straightforward, and only one or two points need special mention. The connection to the negative side of the four electrolytic condensers C27, C28, C33 and C34 is made by their contact with the metal base upon which they are mounted. The chassis, however, is not at the same potential as negative H.T., so that the condenser cans must be insulated from the chassis proper.

The difficulty is got over by cutting through the metal covering of the base all round the four condensers in such a way that they are in contact with a disc of metal which is insulated from the remainder of the chassis by the gap which has been cut and by the plywood base. The two electrolytic condensers C29 and C30 must also have their cans insulated from the chassis, and this is accomplished by mounting them on the underside of the base, which is not metal covered, on a metal bracket. This bracket should be screwed to the wood with short screws so that there is no risk of them coming into contact with the metal covering the other side of the base.

The wiring should be carried out as nearly as possible in accordance with the drawing which accompanies this article, and it should not be forgotten that in the case of the HL.DD.1320 the precise heater connections are not unimportant. The makers recommend that one particular diode be used as the detector, and that the heater connections be made in a certain way in order that the fullest im-

munity from mains hum may be attained.

The coils can be purchased ready built, if desired, or they can quite easily be home-made. The coils used in this receiver are in every way the same as in the original Single-Span set, so those requiring information on their construction are referred to *The Wireless World* for April 27th, 1934.

It may be remarked that the coil L3 is secured to the frame of the tuning condenser by two nuts and bolts. Over the one-hole fixing bush of this condenser are placed, first, the base of the large screening can, and, secondly, the mounting bracket supplied with the dial, the whole assembly being secured by the large nut from the condenser. The padding condenser C is mounted on the screen base by two small brackets in such a manner that its adjusting screw can be reached by inserting a screwdriver through one of the slots in the screen.

If the receiver is to be used on both A.C. and D.C. mains a permanent-magnet-type loud speaker should be used, for the rectifier cannot supply sufficient current for energising a field winding. In cases where the set is to be employed only on a D.C. supply, however, there is no objection to the use of an energised speaker, and it should have a field of suitable resistance for direct connection to the mains. Whatever speaker be used, its transformer must be of such ratio that the primary impedance is 4,400 ohms.

Unless the set is worked from A.C., one might expect to be able safely to omit the rectifier valve. This is not the case, however, for on D.C. it serves to protect the electrolytic condensers from damage. If the rectifier were not in circuit, and the set were connected to a D.C. supply with reversed polarity, the electrolytic condensers would be destroyed.

Initial Voltage Adjustments

The mains resistance R21 is tapped so that any mains between 200 volts and 250 volts can be used, the adjustment being in 10-volt steps. The connection should be made to the appropriate tapping point, bearing in mind that the full resistance must be included for 250 volts. A table of voltages and currents is given in this article, but it must be remembered that the divergencies to be expected are greater than usual. Not only are the usual differences in valves and components of the same nominal type likely to be encountered, but the mains voltage and the nature of the supply also affect the readings which will be obtained. The figures, therefore, should be taken as no more than a guide to the values likely to be found in practice.

The initial adjustments are few in number and readily carried out. Owing to the chassis being at mains potential it is necessary to exercise care in making the adjustments, and it is a wise plan to make a saw-cut in each of the four knobs controlling the I.F. trimmers in order that a screwdriver may be used to operate them. The first step is to set each trimmer at maximum, that is, with its plates fully enmeshed, and make a pencil mark on the underside of the base opposite the pointer on the knob, so that the position

THE latest version of the Single-Span receiver is basically the same as earlier models, but its power supply circuits have been modified to permit of operation interchangeably on A.C. or D.C. supplies. Theoretical considerations affecting design were discussed last week; the present article deals with the practical details of construction and adjustment.

The Universal Single-Span Receiver—

of the trimmer can always be determined without having to remove the coil screen. Take this pencil mark as 180 degrees on an imaginary scale and set C20 at 130 degrees, rotating it in an anti-clockwise direction. A rough division by eye is sufficiently accurate. In the same way set C17 at 135 degrees, C12 at 170 degrees, and C11 at 135 degrees. Screw C7 fully home, and then unscrew it one complete turn.

Trimming the I.F. Circuits

The set can now be switched on, and it should prove possible to tune in some station, and the four I.F. trimmers can be adjusted for maximum signal strength. A milliammeter should now be connected in the anode circuit of one of the controlled valves, or a low-range voltmeter in parallel with R18, so that trimming can be carried out with the aid of a visual tuning indicator. On tuning in a signal, the meter reading will decrease unless the signal is very weak, and the stronger the signal the greater will be the fall of current, so that trimming for minimum current indication of the meter is the same as trimming for maximum signal strength.

Find a moderately strong signal and tune it in as accurately as possible, keeping the set close to the oscillation point by means of reaction without letting it actually oscillate. Then adjust C20 for maximum signals. It may be necessary, if oscillation is to be avoided, to reduce the setting of the reaction condenser C14 as this circuit comes into resonance. Then adjust C17 in exactly the same manner, and, lastly, C11. The set is now trimmed, but if the best performance is required it will pay to repeat the process again, slightly retuning the signal by the main tuning control. The only other adjustment is to C7. If the dial settings are too high, or 2,000 metres cannot be reached, unscrew C7 a little further. On the other hand, if the dial settings are too low, and particularly if long-wave stations can be received at two different dial settings, C7 must be more fully screwed up.

The only other point which might cause difficulty is in the precise frequency to which the I.F. circuits have been adjusted. If the specified components have been used and the trimming instructions carefully followed, their frequency should be quite close to 1,600 kc/s. In general, small divergen-

A full-size blue print of the wiring diagram is available from the Publishers, Dorset House, Stamford Street, London, S.E.1. Price 1s. 6d. post free.

cies have no effect on the performance whatever, but will only affect the dial settings somewhat, for as the intermediate frequency is increased so the total portion of the dial occupied by the 200-2,000 metres band is lessened. Should it so happen, however, that the circuits are lined up to a frequency equal to two or three times that of a powerful local station, it may be found that there is a whistle on every station. If this effect should be found in any case, it is a simple matter to remedy it by re-trimming the circuits at a slightly different frequency.

Except in the case of weak signals, or where a poor aerial is used, reaction will make little difference to volume, since the increase in sensitivity which it brings about is offset by the action of A.V.C. It makes quite a large difference to selectivity, how-

to possess adequate sensitivity for the reception of all musically worth-while Continental transmitters when used with an aerial of average efficiency, and this without pressing reaction to the limit. Some of the stronger Continental stations, in fact, are receivable at good strength with reaction at minimum. Under this condition, of course, selectivity is not high, and the local station spreads by some seven channels. The quality of reproduction is outstandingly good.

True and Apparent Selectivity

The effect of applying reaction is greatly to increase selectivity, but owing to the simultaneous increase in sensitivity the spread of the local is not reduced unless a station is tuned in which is strong enough to bring A.V.C. into action. This makes the feel of the set a little unusual, and the apparent selectivity is much lower than the true selectivity under suitable conditions. If the set be used at night when distant transmissions are fairly

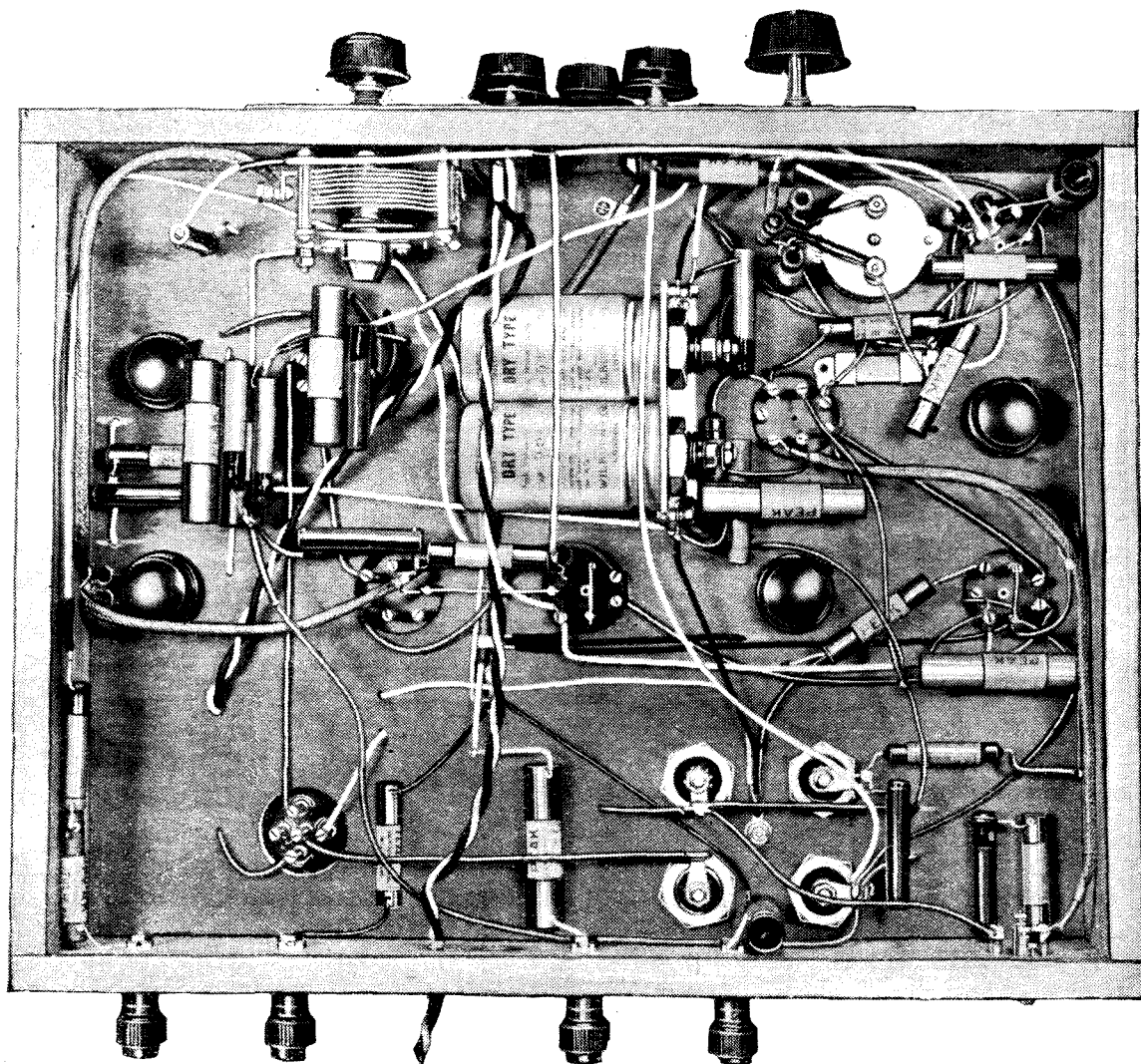

The underside of the baseboard, where most of the wiring is concentrated.

ever, and will be found very valuable when interference is at all rife. This property of variable selectivity is exceedingly valuable, for it enables the best quality consistent with the prevailing interference to be always obtained.

Thorough testing has shown the receiver

strong, it is not difficult to receive stations only three channels away from the local without interference, whereas with the weaker signals prevailing during the daylight hours seven channels is about the limit.

The quality of reproduction proved

LAY-OUT AND PRACTICAL WIRING PLAN

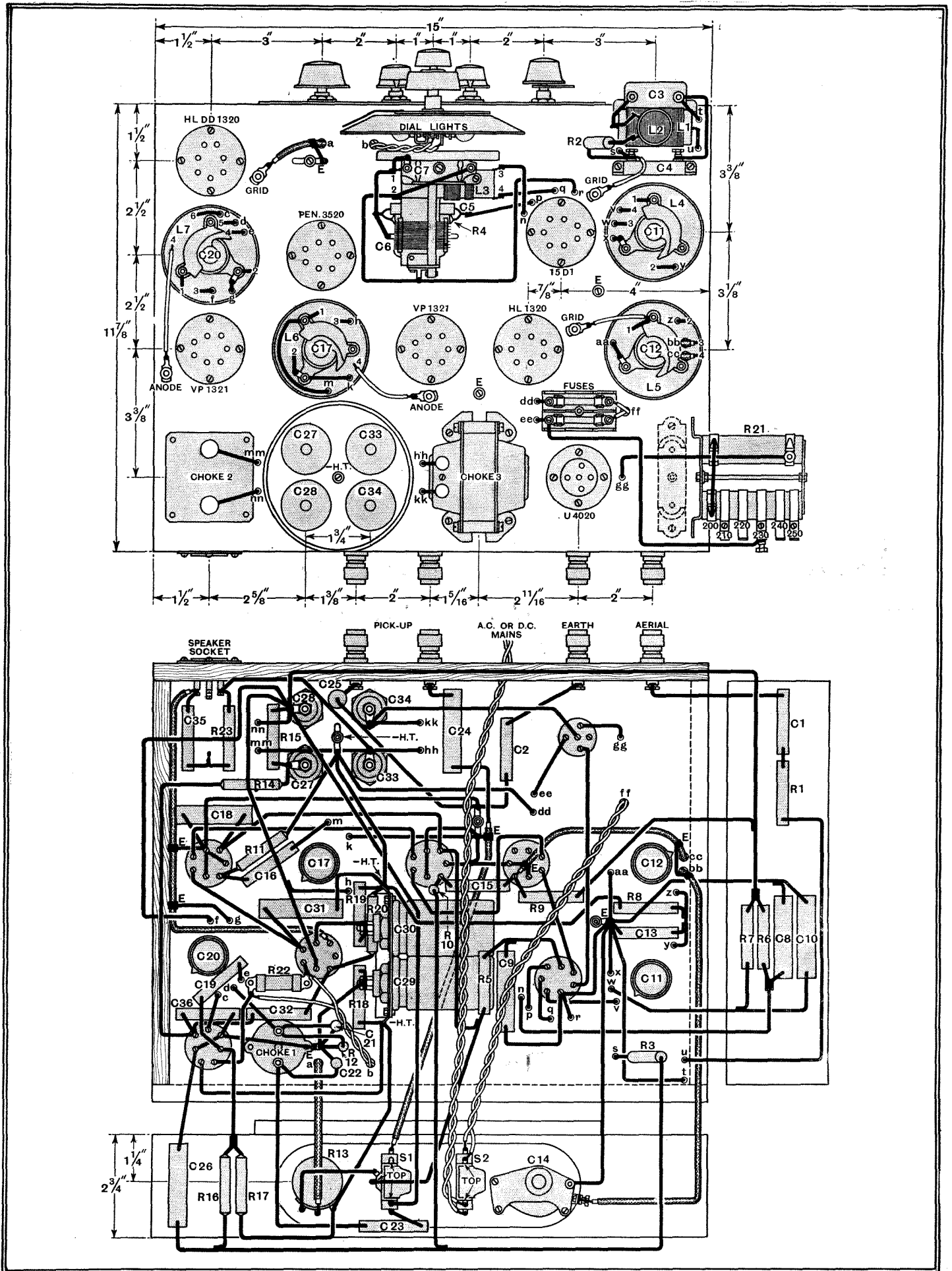

The complete practical wiring plan ; the upper drawing indicates connections above the baseboard and also shows positions of components.

The Universal Single-Span Receiver—highly satisfactory, and the volume is adequate for most purposes. The unusually good conditions prevailing as regards quality are to be attributed partly to the moderate degree of sideband cutting in the tuned circuits, and partly to the characteristics of the particular output pentode employed. This valve does not re-

quire a high value of load impedance, with the result that matching to the loud speaker is facilitated, and it is capable of quite a large output for a moderate anode voltage.

VOLTAGES AND CURRENTS.

Valve.	Anode Volts.	Screen Volts.	Grid Bias.	Anode Current.	Screen Current.
F.C. 15 D. 1—				mA.	mA.
Tetrode	145	50	-1.6	1.6	1.75
Oscillator	90	—	—	2.0	—
Buffer HL. 1320	70	—	-1.6	1.1	—
1st I.F. VP. 1321	145	145	-1.6	4.2	1.4
2nd I.F. VP. 1321	145	145	-1.6	6.5	1.4
Det. HL. DD. 1320	55	—	-1.6	0.5	—
Out. Pen. 3520	150	145	-5.1	29.5	5.1

quire a high value of load impedance, with the result that matching to the loud speaker is facilitated, and it is capable of quite a large output for a moderate anode voltage.

Mains hum proved to be negligible, and, indeed, inaudible. It may be remarked, however, that with a receiver of this type,

chokes and a pair of fixed condensers, but it has not been thought worth while to include it in the receiver itself, since it will only prove necessary in rare cases.

A specimen receiver built to the specification described in this article is available for inspection by readers at 116, Fleet Street, E.C.4.

Home-Made Signals

Building and Using a Simple Modulated Oscillator

By EDMUND J. KING

THE advantages of having available a source of "home-grown" signals, of which the wavelength and strength may be adjusted at will, need hardly be stressed. A simple valve oscillator has its uses for testing purposes, but as the output is unmodulated, its scope is severely limited. The self-modulating oscillator to be described has been used by the writer for a considerable time with great success; it has, indeed, been invaluable in many ways, and has been found to be extremely certain in operation.

As will be seen from the accompanying diagram, a pentode is employed as an oscillator, modulation at an audible frequency being produced by the periodic discharge of a condenser through a grid leak. The actual oscillator circuit is of the Hartley type, with centre-tapped coils.

Arrangements are made to apply, by means of an attenuator, varying proportions of the output to the receiver or circuits under test. The attenuator actually consists of a potentiometer fed through a very small two-plate condenser (NC in the diagram) which is actually an old neutralising condenser. To avoid misleading results, it is important that the oscillator should be completely shielded, and that the output from the attenuator should be passed to the set through a shielded lead; in practice, terminal A and the metal braiding of the connecting wire (ter-

minal B) are joined respectively to aerial and earth terminals of the receiver under test.

Both sides of the variable condenser are "live," and therefore its spindle, and incidentally that of the attenuator potentiometer, must be insulated.

The size of the screening box will depend upon the components used, and it is not difficult to make an extremely com-

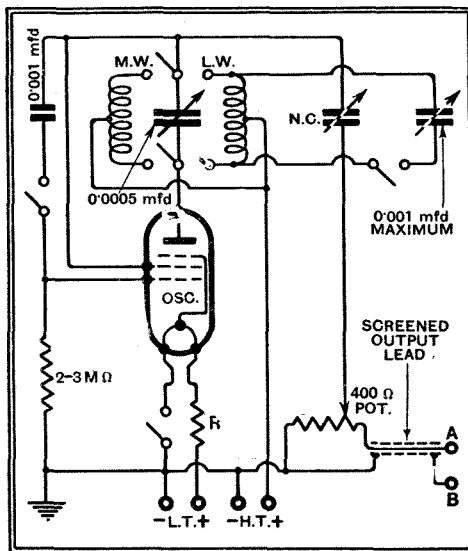

The complete modulated oscillator: the attenuator is useful for making comparative tests.

FOREIGN BROADCAST GUIDE

FRANKFURT-AM-MAIN

(Germany).

Geographical position: 50° 6' N.; 8° 40' E.

Approximate airline from London: 396 miles.

Wavelength: 251 m. Frequency: 1,195 kc/s
Power: 17 kW.

Standard time: Central European (coincides with B.S.T.).

Standard Daily Transmissions:

B.S.T.: Continuous transmission throughout the day; 05.50 and 06.15 (ex. Sun. and Mon.), physical exercises; 06.15 (Sun.) con.; 06.55 con.; 08.20 (ex. Sun. and Mon.) physical exercises; 12.00 con.; 18.00 talks, plays, etc.; 20.00 main evening programme; 22.20 Time Signal, news, sport; closes down at approx. 01.00 (ex. Sun. and Mon.), when dance music is given until 02.00 (Mon. and Tues., respectively).

Announcer: Man.

Interval signal: Three bars from The Watch on the Rhine (Die Wacht am Rhein), as under:



Call: *Hier Reichsender Frankfurt*, if from own studio; *Hier Reichsender Stuttgart*, when relaying from Stuttgart.

Usually closes down by playing *Deutschland Ueber Alles* and the *Horst Wessel Lied* (Nazi Marching Song).

Relays: Freiburg (5 kW.), Kaiserslautern (1.5 kW.) Kassel (1.5 kW.) and Trier (2 kW.) on common wave of 251 m (1,195 kcs.).

compact instrument. Care must be taken to provide reasonable spacing between the coils and the metal work, but otherwise the internal lay-out is not important.

Existing coils can often be modified for use in the oscillator, but those who wish to make their own can wind them on an ebonite former of 2½ ins. diameter, the medium-wave winding consisting of about 60 turns of No. 28 D.S.C., and the long-wave winding of a total of 240 turns of No. 36 D.S.C., equally disposed in four adjacent slots. This is on the assumption that the normal broadcast wave-ranges are to be covered; with the help of an additional semi-variable condenser of 0.001 mfd., which may be switched in at will, the usual intermediate frequency range of superheterodynes is also covered.

Oscillator Calibration

If it be decided to prepare an accurate calibration of the tuned circuit, precautions must be taken to ensure that all factors which might influence the frequency are constant; H.T. and L.T. voltages, grid leak value, attenuator feed condenser and attenuator resistance will affect calibration if allowed to vary. However, variations of frequency through adjustment of the attenuator are fortunately negligible for most practical purposes.

A Mazda pentode valve, type Pen. 220, was used, the resistance R in the filament circuit being necessary for absorbing surplus voltage when the filament is fed from a two-cell dry battery, as is very convenient for intermittent work. An ordinary 4½-volt dry battery is sufficient for H.T. purposes.

Broadcasting under Hitler

An Instrument of Government Propaganda

By "WANDERING WAVE"

NO listener can stand undiluted propaganda, and this is the main reason why entertainment and instruction still find a place in the German broadcast programmes. Nevertheless, the broadcasting system has been an instrument of propaganda ever since the advent of the Hitler Government.

The steady changes in the system culminated in the entire reorganisation pro-

COMPLETE reorganisation to cope with changes in political power—this is the story of German broadcasting during the past twelve months. Our correspondent, a resident in Germany, gives first-hand impressions of the working of the new regime and describes how the Hitler Government, with the aid of trained "radio officers," ensures that Government broadcasts are brought within the reach of everyone in the country.

claimed on April 1st last. On that day the nine broadcasting companies were dissolved and the holding company, the Reichsrundfunkgesellschaft, became the one and only broadcasting organisation over the whole country. The individual stations became branch offices under the title of "Reichssender," and the company providing the news became a department in the Ministry of Propaganda.

This sweeping reform was only possible after the dissolution of the individual German Federal States by Herr Hitler in January, 1934.

The Post Office formerly owning 51 per cent. of the shares in the broadcasting organisations (the other 49 per cent. being in the hands of the Federal States) relinquished these in favour of the Propaganda Ministry, which also took possession of the remaining 49 per cent. Thus, under Hitler, the Ministry for the Enlightenment of the People and Propaganda is sole owner of the German broadcasting organisation. The Post Office has, however, retained the work of collecting the fees and operating and installing transmitters and cables. For this service it retains about half of the licence fees, the remainder being passed on to the Propaganda Ministry.

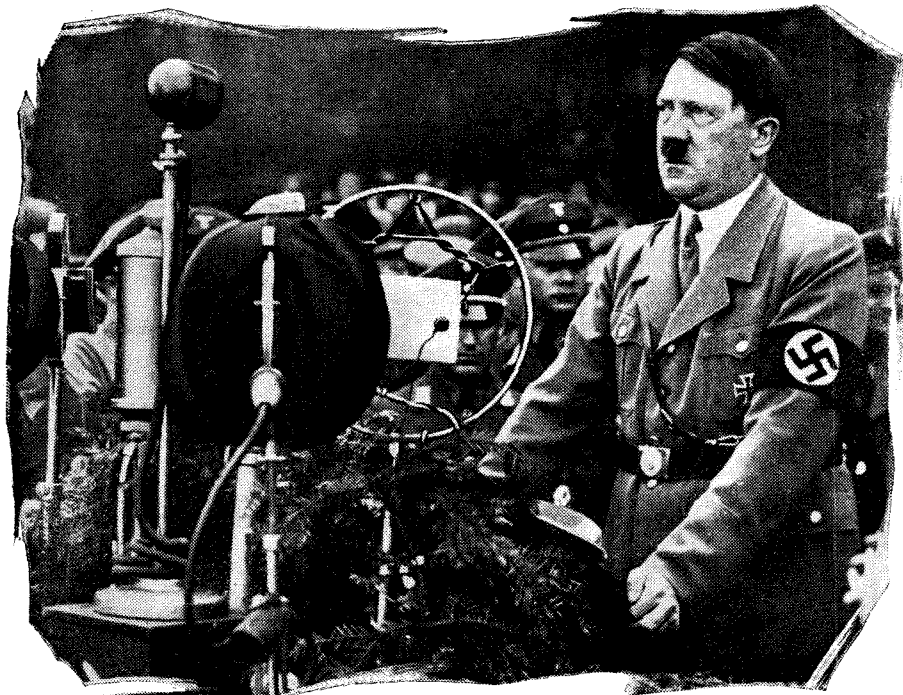

Herr Hitler facing the customary battery of broadcast, public address and film microphones.

Dr. Goebbels, the Minister of Propaganda, is thus the ultimate head and sole controller. So far as political control is concerned his work is simple; everything that is not National Socialist is automatically rejected, the country having only one political opinion.

In a sense German broadcasting is organised along the same lines as the

British system, with the exception that the R.R.G. has not the political independence of the B.B.C. In Germany, Herr Hitler has proclaimed the slogan: "Every German a Listener," this declaration conforming to his policy of using broadcasting as a direct link between Government and people.

To put this slogan into practice it was necessary to ensure that every German should have good reception, and listening had to be organised. On every great political occasion, when the German people expect to hear a Government announcement, an army of National Socialist "Funkwarte," or radio officers, all over the country install receivers and public address equipment wherever the masses will gather. At least half the population gathered in front of loud speakers on such occasions as the May Day demonstrations in 1933 and 1934, the great Hitler speech before the elections in November, 1933, and the proclamation of the second year's campaign against unemployment last March. In some places traffic was entirely stopped, shop doors were closed and factories became idle.

Increasing Local Range

Transmission was also reorganised, the Government deciding to increase the power of the broadcasting stations to the maximum internationally permitted, i.e., 100 kilowatts on the medium, and 150 kilowatts on the long waves. Further to increase the efficiency of the stations, anti-fading aerials were provided for new high-power transmitters, and those stations having older types of aerials will shortly



The "Deutschlandsender"—Berlin's 100-kW. station—with its anti-fading aerial.

Broadcasting under Hitler—

obtain new ones. These anti-fading aerials increase the local service range by about one-third, while distant reception is not impaired.

The power of the relay stations is also being increased, and in places where reception of the high-power transmitters is not sufficient further relays are being provided which work on national or international common waves.

This programme of expansion will be completed by the end of 1934. Already Hamburg, Berlin, Munich and Stuttgart have 100-kilowatt transmitters operating on the anti-fading type of aerial. Work is progressing to increase the power of Heilsberg, Breslau and Langenberg stations from their present 60 kilowatts to

with the means for good and inexpensive reception by creating the "Volksempfänger," or "People's Receiver," while the system of transmitters just described

nisable. These signals are produced in various ways; at one time it was intended to make use of the talking film, but since visiting America the R.R.G. research en-

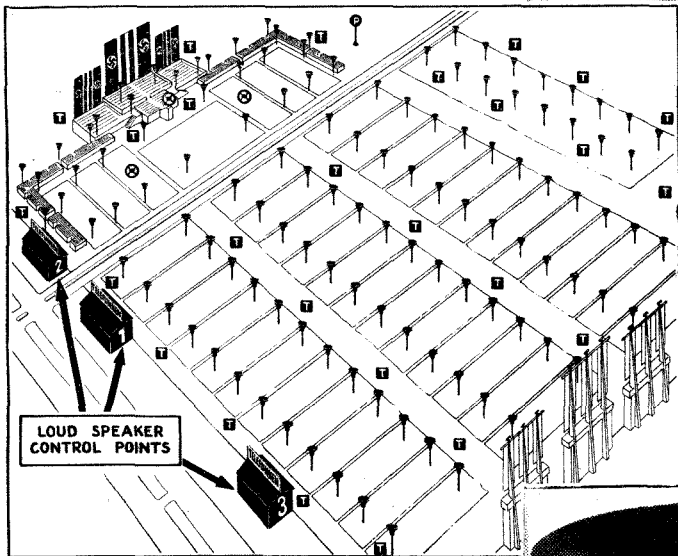
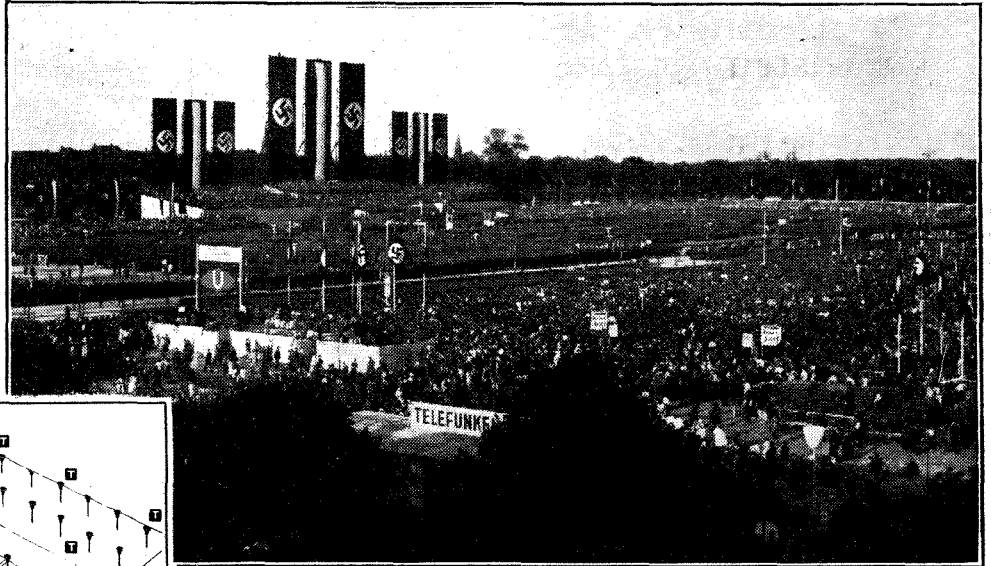

Public address on a gigantic scale—the May Day celebrations in the Tempelhofer Field, Berlin, in May last. The plan shows the disposition of the new Telefunken "mushroom" speakers, which are illustrated below.

100 kilowatts and at the same time to provide these stations with the new type of aerial. Leipzig, which already has 120 kilowatts, will shortly obtain the new aerial. At Stettin, Dresden and Königsberg, the old relays have been replaced by more modern transmitters, and a new relay station has been opened at Trier. The power of the Freiburg relay station has been increased to 5 kilowatts and an anti-fading aerial has been provided. The Post Office has placed an order for a new 150-kilowatt long-wave station to replace the present Deutschlandsender. This will be completed in 1935.

The "People's Receiver"

In addition to this system of national development, the Germans have opened a short-wave station consisting of two transmitters, operating on nine beam aerials, for broadcasting to the world at large. This station was opened in February, 1934, and will shortly be provided with more powerful transmitters.

The Hitler Government, in providing Germany with eight 100-kilowatt stations, one 150-kilowatt long-wave station, numbers of relays and with powerful short-wave beam broadcasters, has made the country one of the most powerful broadcasters in Europe.

It has provided the entire population

makes the reception of German stations so easy and so good that few people will turn to foreign stations. It would be too much to say that Germany is water-tight as far as foreign broadcast propaganda is concerned, but German broadcasting has done all in its power at least to approach this.

The new system of musical signature tunes or interval signals adopted by the German stations makes them easily recog-

gineer concerned has decided on an entirely new principle for interval signals, which, unfortunately, cannot yet be disclosed.

The work of the "Funkwarte" or radio officers, already referred to, promises to widen its scope. At the present time they are keeping a watchful eye on the licence figures, and have completed a series of investigations into why the number of listeners has recently declined. In all, 12,237 cases were treated.

No fewer than forty-eight reasons were adduced for the abandonment of the wireless receiver. It is possibly surprising that only 9 per cent. of "defaulters" indicated that they were no longer interested in the transmissions; in many of these cases the Nazi officers concluded that the reason was a seasonal one. In 4½ per cent. of the cases the receiver had broken down and was past repair and its owner could not afford a new one.

The Domestic Side

Hire purchase features largely in the dissemination of wireless sets, but only six instances are recorded in which the purchaser was unable to keep pace with the instalments. Misfortune dogged certain listeners; seven had their receivers stolen, but this is nothing compared with the tragedy of the eleven who had been sent to prison or to a concentration camp.

Twenty-eight people gave up listening because they had married, while nine pleaded an increase in the size of the family. The desire for an increased population may prompt the authorities to provide free licences in the case of large families.

The "Funkwarte" will be mustered in full force for the forthcoming Berlin Radio Show, to be held in August. Arrangements include technical lectures and demonstrations which should brace the officers for their increasingly arduous duties in the coming winter.

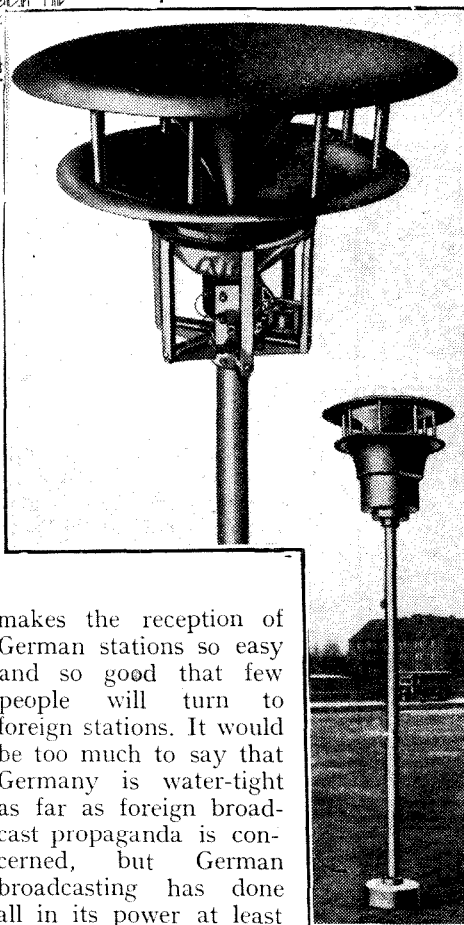

Broadcast Distribution

How Droitwich Will Affect the Regional Scheme

By NOEL ASHBRIDGE, B.Sc.

(Chief Engineer, British Broadcasting Corporation)

(Concluded from page 5 of last issue.)

“WHEN the new stations (North Scottish, North-Eastern and Belfast) are built, and with Droitwich in co-operation,” writes the B.B.C.’s Chief Engineer, “it is anticipated that 98 per cent. of the population will receive a good service of one programme and 85 per cent. two programmes.”

The article deals with the decisions which have led to the new distribution arrangements and indicates how Droitwich will serve the country at large.

EXPERIMENTAL work in connection with the design of the new high-power medium-wave transmitter was complete by the summer of 1927, and in August the transmitter (known as 5GB) began to transmit a programme which was definitely contrasted with that sent out by 5XX. Below is a photograph of the experimental transmitter 5GB. It should be explained that at this time it was still considered that there was a possibility of trouble due to receivers located within about ten miles of the station not being able to separate entirely one programme from the other. The

The new high-power station at Droitwich nearing completion.

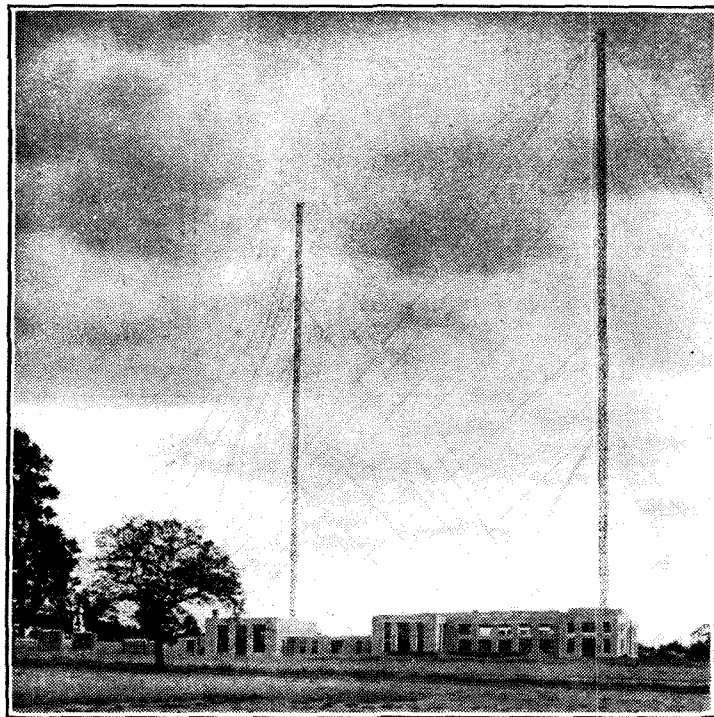

problem had, however, been investigated with two small transmitters working on about 10 watts at Keston (at the receiving station then normally used for monitoring), and it had been shown that all that was usually necessary was to reduce the size of aerial used if selectivity trouble were experienced, provided, of course, that the set possessed at least some degree of selectivity. However, it was decided to confirm this finding on a basis of high-powered stations transmitting programmes for the benefit of listeners. It was thought also that there might be serious difficulty due to cross-talk between the two transmitters—that is to say, the radiation from the one being picked up and re-radiated in some way by the other. As a matter of fact, a certain amount of short-lived difficulty was experienced in connection with the latter for a few days, probably because both transmitters concerned were un-screened, but the judicious application of a few condensers and high-frequency chokes removed this trouble entirely.

After some discussion with interested Government Departments a decision was finally reached to proceed with the construction of the London twin transmitter station. Some months were required to find, test, and purchase a suitable site, and the constructional work

began at Brookmans Park in July, 1928. The station began its preliminary trials during the following summer, and was first put into regular operation in September, 1929. In spite of the preliminary tests which had been made at Daventry in connection with 5XX and 5GB, there was still a certain amount of fear remaining that listeners might have trouble in such areas as Potters Bar, Barnet, etc., and pamphlets were got out in order to try and help all those in trouble as much as possible. It will be realised that there was more separation between the wavelengths of 5XX and 5GB than between the two Brookmans Park transmitters. At the same time the service of two programmes was “slid in” very gradually. There was, as a matter of fact, a certain amount of difficulty due to lack of selectivity, which, however, was almost entirely concerned with old receivers; relatively old, that is to say, because broadcasting had only been running for some six years.

Completing the Regional Scheme

Altogether, about 47,000 letters were received, but few of these protested against the nature of the service; they were more in the nature of requests for information as to the fitting of rejector circuits, series condensers in the aerial, coupled circuits, shortening of aerials, etc. However, to convince anyone who considered that the separation between the two wavelengths used was insufficient, a crystal set was erected in the Brookmans Park building, complete with a reasonable size of aerial, which would separate the two programmes completely.

Brookmans Park, having ultimately proved a success, the remaining three sta-

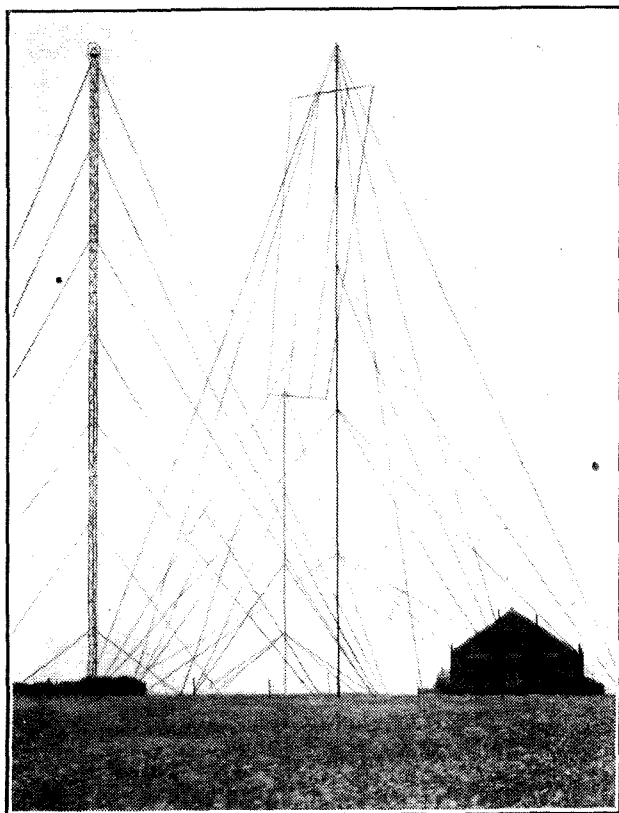

The experimental transmitter 5GB at Daventry, now known as Midland Regional.

Broadcast Distribution—

tions were built during the following three years, the last station—at Washford Cross—in the West being finished in April, 1933. In the case of the last three stations the selectivity trouble was very much less in evidence than in London; in fact, only seventy-nine letters on this subject were received from the West Region.

Synchronising Problems

Perhaps the most anxious time in the development of the scheme was when the West National and London National were put on the air for the first time "synchronised" on the common wavelength of 261.6 metres. It was necessary to do this, because there were not enough wavelengths available to give a separate one to each transmitter. These two were chosen for "synchronising" purposes rather than two others farther apart, such as London National and Scottish National, because, according to our measurements, less indirect ray was in evidence during darkness on this frequency at a distance of the order of 150 miles than at 300 miles, which are roughly the respective distances in the two cases mentioned. The degree of accuracy of "synchronisation" of the two carrier waves on a basis of several months' working varies between 0 and about 3 cycles—that is, an average of about $1\frac{1}{2}$ parts in a million. It may be said that better results have been obtained than we in the B.B.C. anticipated—that is to say, the service area in each case is slightly greater than that which we mapped out when deciding to attempt this method of working. We assumed that a ratio between the wanted and unwanted field of 5 : 1 would be necessary; in practice, however, satisfactory results are being obtained with about 3 : 1. Of course, the worst condition is given in places where the strengths of two stations are equal.

The opening of the West Regional Station really completed the original Regional Scheme, although it had been intended for some time past to increase the power of 5XX. This had not already been done because there remained some doubt as to what maximum power would be

allowed for the new station, on the one hand, internationally, and, on the other, by the Government.

During the summer of 1933 earnest consideration was given to the lines on which future development should proceed, on the assumption that the new 5XX would be operated on some power above 100 kW., it being realised that at this stage in the development of broadcasting almost continu-

say, London National, North National and West National—and to give the national programme to those three regions from the new 5XX. The main reasons for this were two-fold. First, it had been decided to build the new long-wave station at Droitwich instead of Daventry, which helped to make it possible to obtain a licence to work on 150 kW.; and, secondly, because it was clear that the selectivity of receivers

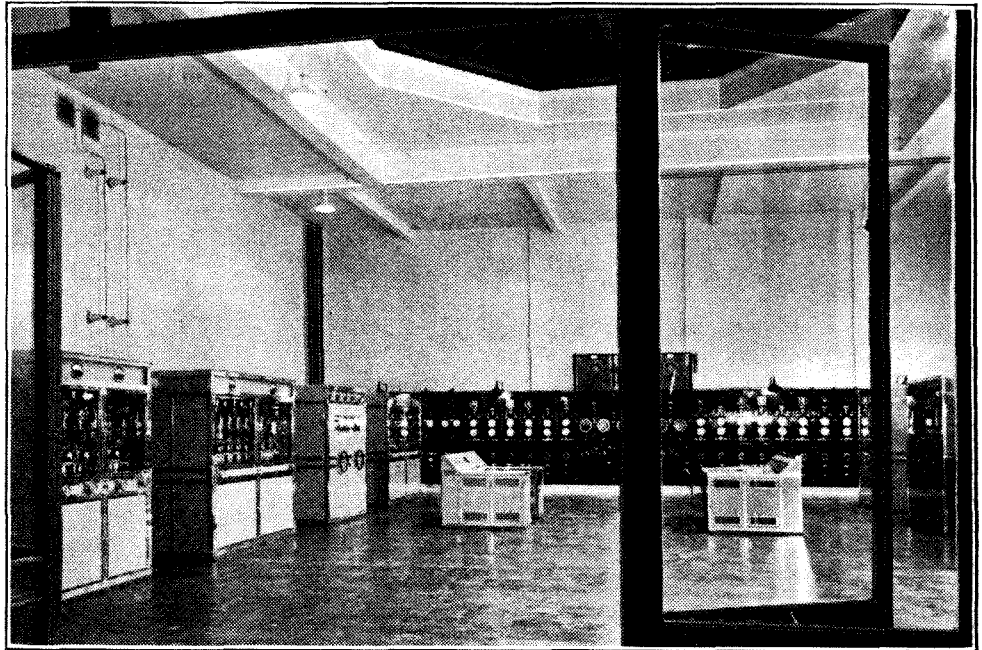

The transmitter hall at West Regional.

ous movement was necessary in order to remain up to date and to give the best possible service with the facilities—in the shape of wavelengths—which were available. It was not until after the Lucerne Conference, which took place in June of that year, that it was possible finally to adopt any definite scheme for future development, because the number of channels likely to be available was in doubt. Even now there is still some element of doubt as to the future. However, by the autumn of 1933 a decision had been taken ultimately to close down the three national transmitters working on medium waves serving England and Wales—that is to

in a year or two's time was likely to be amply sufficient to distinguish between two transmissions with 200 or 300 kc/s separation, even if they were not roughly equal. In short, it was considered that there would be no difficulty in eliminating the medium-wave regional transmission with a field of 100 mv/m or so to receive a transmission from the new 5XX, with perhaps 10 mv/m. It was not intended to put this scheme into operation immediately, but only after a further year or two, after which the Droitwich Station would be completed, it not having been started at that time.

The great advantage of this scheme was, of course, that two wavelengths would be released, which could be used to increase the coverage of the regional programme service. The aim was to cover as much ground as possible with 5XX giving the national programme, in order that the medium wavelengths might be used for regional programmes; however, it was decided to retain the "national" transmitter in Scotland if Droitwich were not strong enough for good reception in the densely populated districts of Glasgow and Edinburgh. It will not be possible to go into all the various considerations which led to the decision to use one of the two free wavelengths in the North of Scotland and the other in the Newcastle area. Stated very briefly, it may be said that in the first case there is no really good service of even one programme, and in the second there is a relatively poor regional service over an area containing a very large popula-

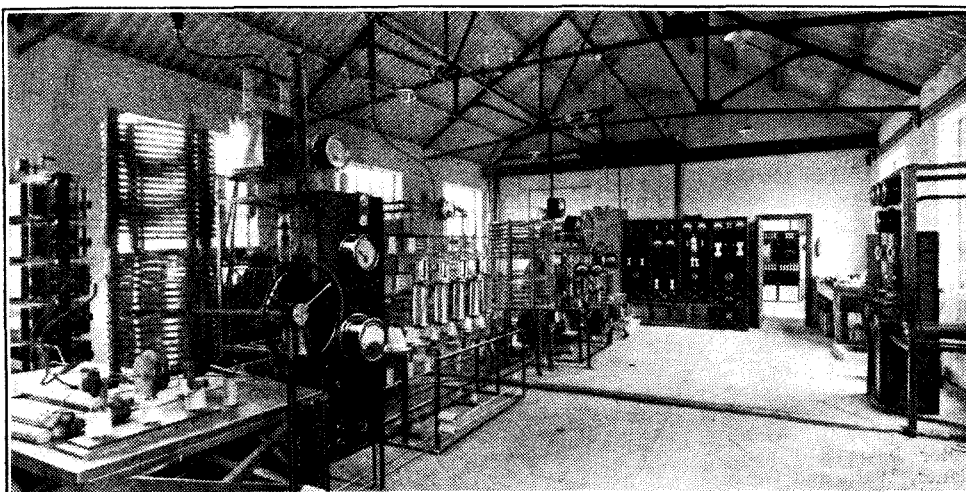

General view of the 5GB transmitter. The final stage of the power amplifier is in the centre background.

Broadcast Distribution—

tion. In addition to the two new single-wave stations a similar station is to be built in Northern Ireland to replace the small Belfast transmitter. The national programme will be supplied to this area from Droitwich.

These proposals, which I have stated briefly, were submitted in full to a committee of independent experts, who, after careful consideration, approved the whole scheme. The latter includes many details, such as arrangements for using the national transmitters which are to be closed down for the new stations which are to be built.

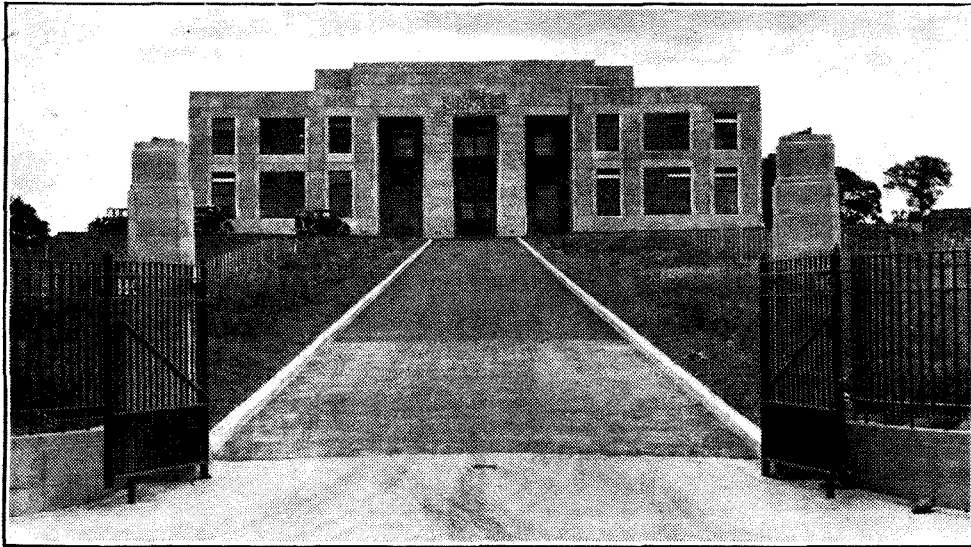

DROITWICH. The main entrance to the station. Unmodulated test signals may be expected after broadcasting hours within the next few days.

When the new stations are built, and with Droitwich in operation, it is anticipated that 98 per cent. of the population will receive a good service of one programme, and 85 per cent. two programmes.

What Droitwich Will Do

Returning for a moment to the principal change involved in this scheme, i.e., giving the national programme to the whole of England, Wales and Northern Ireland from Droitwich; it has already been argued in certain quarters that the new 5XX will not give a service so free from interference in the big cities, for example, London, than is at present given by the medium-wave national transmitter at Brookmans Park. The case of London has been taken because any such complaints would be more likely to come from that area than from the other regional areas who are losing their national transmitters, because in this case a larger number of listeners have been in the habit of receiving the national programme from a medium-wave transmitter than in the other two regions. Moreover, this has been going on for a long time, nearly five years.

It can be said straight away that in the northern districts of London it is obvious that the reception of the new station cannot be as interference-free as that which exists at present. The field strength in,

say, Finchley, from the London National is of the order of 60-80 mv/m., while that from Droitwich will be of the order of from 15-20 mv/m. On the other hand, if you take a district like Chelsea it will be found that at present the field strength from London National is about 4 mv/m., whereas the field strength from Droitwich will be approximately the same as that mentioned above. In the eastern districts the field strength will probably be about the same in the two cases, although admittedly there might be greater freedom from interference on the medium than on the long wave. Finally, if you take an area such

as Croydon, it will be found that the new station will give a gain of about 3-1. On an average, therefore, the service in London itself should not be appreciably worse than it is now, although possibly it will be necessary for some people in the north of London to use an aerial where they have been in the habit of working with practically no aerial. However, it seems reasonable to assume that listeners will be prepared to go to some trouble in this connection if they realise that the change will allow ultimately two or three million

people to get a better service in the north of England, and a considerable, although much smaller, number in the north of Scotland to get a good service for the first time since broadcasting started. Put another way, it seems hardly justifiable to duplicate a programme on a medium-wave transmitter which will exist with a strength of 20 mv/m. from another station.

An All-Britain Service ?

The next point which will arise is why the number of people who are served with a minimum of one programme is 98 per cent. and not 100 per cent. The answer to this is that this figure refers to a consistently good service. The service from Droitwich will extend over the whole of the British Isles when conditions are good. It is not practicable, however, to give completely reliable reception from Droitwich in such areas as the extreme north and west of Scotland. If one attempted to do so by choosing a site farther north, it would mean giving an unreliable service to vastly greater numbers in some other part of the British Isles, unless a power of many hundreds of kilowatts were used, which is not allowed by international regulation. Next, it may be asked, is there any hope of the 15 per cent. of the population who do not get a regional service ever getting such a service in the future? Again, it has to be pointed out that the figure of 85 per cent. is on the basis of a good service, and a larger percentage will get a less good one. Moreover, by improving the low-power stations which already exist (with the exception of Newcastle, which, of course, will be closed down when a high-power station is built in that area), and possibly by building additional relay stations, it is hoped to reduce this 15 per cent. It would, however, be very premature to say that additional relay stations can be built, or to estimate to what extent the 15 per cent. can be reduced. Finally, it is necessary to repeat what has been said so many times before, namely that future developments always depend on the result of future international conferences.

The Radio Industry

WE learn that the Earl permanent-magnet loud speakers, models A.38 and E.38, have been approved as suitable for use in schools by the Central Council for School Broadcasting.

◆ ◆ ◆ ◆ ◆
The new Osram Catkin valve, type VMP.4, is a variable-mu screened pentode for A.C. operation, and costs 17s. 6d.—the same price as the equivalent glass valve which it may ultimately replace.

◆ ◆ ◆ ◆ ◆
For use in screening the ignition cable of radio-equipped cars, motor boats and aeroplanes, Ward and Goldstone, Ltd., of Frederick Road, Salford, Lancs., have produced metal-braided sleeving with an internal diameter of about $\frac{7}{16}$ in. Suitable earthing clips are avail-

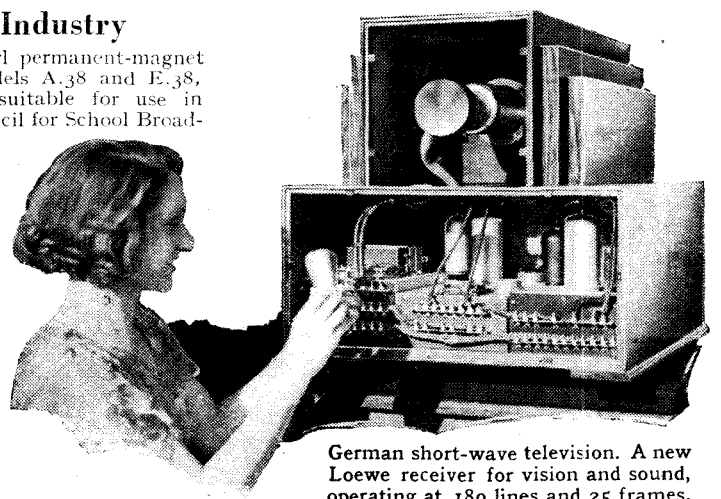

German short-wave television. A new Loewe receiver for vision and sound, operating at 180 lines and 25 frames.

able. The same firm have introduced a "Negrolac" aerial for motor cars, supplied with insulators, down-lead, connectors, etc.

NEW APPARATUS REVIEWED

Latest Products of the Manufacturers

B.S.R. PERMANENT-MAGNET LOUD SPEAKER.

IN view of the tendency towards standardisation of performance in moderately priced moving-coil loud speakers, it is gratifying to find a real attempt to overcome the deficiencies—particularly in bass response—which are generally associated with units of the permanent-magnet type.

In this instrument the fundamental resonance is below 50 cycles instead of at 100 cycles, as is usual. As a result of this, and the fact that a large 9 per cent. cobalt magnet is employed, the bass response is exceptionally full and uniform. The quality of the bass shows up to best advantage in the reproduction of the organ, in which the pedal notes are given out with absolute uniformity of volume and tone value.

Apart from small resonances at 225 and 2,800 cycles, the response is aurally uniform up to 4,500 cycles, above which there is a gradual tail-off, though the response up to 10,000 cycles is much superior to that of the average permanent-magnet unit.

A corrugated type of diaphragm on a leather surround has been adopted, and a doped fabric disc, which is used to centre

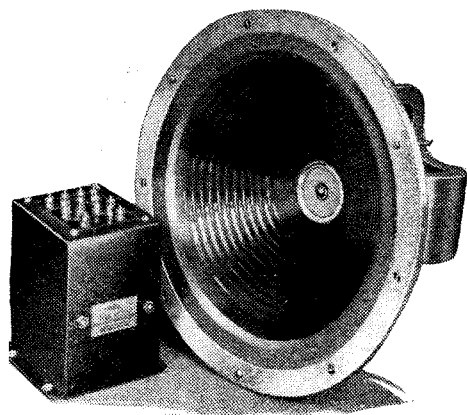

B.S.R. heavy-duty permanent-magnet moving-coil loud speaker and output transformer.

the apex of the cone, prevents the ingress of dust to the gap.

The unit as a whole has been designed for heavy duty, and should be well suited for continuous use in dance halls and for public address work. The makers are Birmingham Sound Reproducers, Ltd., Claremont Street, Old Hill, Staffs, and the price is £5 17s. 6d. Special output transformers for single or push-pull output stages are available at 25s.

DAVENSET CHOKE

MESSRS. PARTRIDGE, WILSON, and Co., Ltd., Davenset Works, Evington Valley Road, Leicester, are making a smoothing choke, type 106, suitable for the Push-Pull Quality Amplifier recently described in *The Wireless World*. This choke has a measured resistance of 128 ohms, and its inductance when carrying 120 mA. direct current is about 8.5 H. It is of the constant inductance type, and the inductance varies no more than from 10.5 H. to 8.5 H. when the direct current is varied from zero to 120 mA.

The choke is exceptionally well finished

and provided with three sets of mounting feet. The terminals are countersunk in the polished ebonite panel, and a small screw-driver is provided for tightening the grub

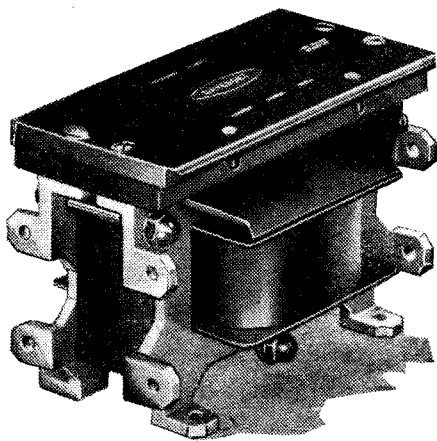

Davenset smoothing choke, type 106.

screws. The choke can confidently be recommended for use in the Push-Pull Quality Amplifier or wherever a choke of similar characteristics is required. The price is 15s.

RADIOPHONE CONDENSER AND DIALS

THE latest British Radiophone three-gang condenser is assembled in a strong frame built up from sheet steel, the whole assembly being extremely rigid. A strong frame capable of withstanding jolts and jars in transit is most essential for a condenser of this type, and particularly so where the matching of the capacities has been carried out to within such fine limits as in the present case.

The specimen tested—a three-gang model with sections of equal capacity—is listed as the type 604. It measures 3½ in. wide, 3¾ in. high and 4½ in. deep, and has the small trimmers mounted on the top. Separate contact springs are fitted for each rotor section and provision is made for fixing the dial on to the end of the frame so that the dial and the condenser form one complete assembly. With the trimmer fully unscrewed the minimum capacity of a section was 22 mmfds. and the maximum capacity 498 mmfds., thus affording a variation of 476 mmfds. The trimmers allow a maxi-

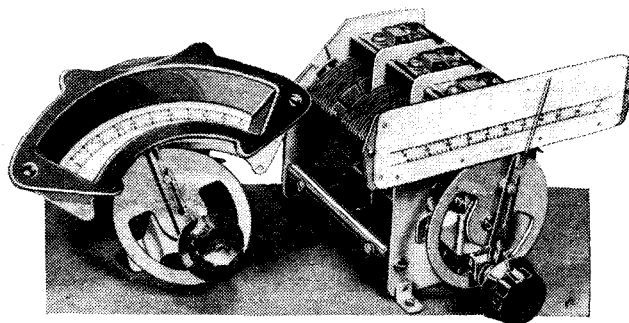

British Radiophone, type 604, three-gang condenser and new dials.

imum of approximately 60 mmfds. for taking up stray capacities in the circuit, the difference in the maximum of each, due to variation in the thickness of the mica, being only one or two mmfds.

At no part of the scale did the difference

in the capacities of each section exceed 0.5 mmfds., while this figure was actually improved on at the lower dial settings and was better than 0.5 per cent. of the capacity. The condenser is a thoroughly sound engineering job and the price is 20s.

The two new dials are listed as the types 802 and 803 respectively, the former having an horizontal and the latter a curved scale. The reduction ratio is approximately 10 to 1, and they cost 6s. 6d. each. The engraving is neat and attractive and stands out well when illuminated, for which purpose twin-dial lamps are fitted at the back. As mentioned above they are fixed on the frame of the condenser and the combination forms a most attractive assembly which should find favour with the discriminating home constructor. The makers are British Radiophone, Ltd., Aldwych House, Aldwych, London, W.C.2.

NEW BENJAMIN TRANSFEEDA

A NUMBER of minor but important improvements have been made in the Benjamin Transfeeda, which, however, still retains its familiar appearance, as the changes all relate to the internal construction. The new model incorporates a 1 to 3½ ratio transformer and a high-voltage test condenser. The small terminals have been redesigned and are now formed in one piece with the internal soldering tags, whereas in the older model they were separate and riveted together.

New model Benjamin Transfeeda embodying 1 to 3½ ratio transformer and several minor improvements.

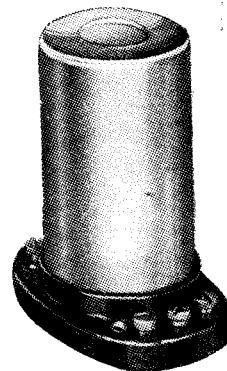

As a result of the changes in the electrical constants of the windings the component gives a greater overall amplification, yet the bass is still maintained at a satisfactorily high level down to well below 100 cycles. The new model gave about one-and-a-half times the amplification of an early specimen when tested in the same circuit, and we obtained the best results, as regards uniformity of amplification over the usual frequency range, when using a preceding valve of about 10,000 ohms A.C. resistance. As most A.C. detector-type valves are of medium impedance the unit will be operated under its most favourable conditions.

Only the 30,000-ohm portion of the anode resistance was included in the anode feed circuit, the remaining 20,000 ohms being employed for decoupling.

The price of the modified unit remains the same, namely, 11s. 6d., and the makers are Benjamin Electric, Ltd., Brentwood Works, Tariff Road, Tottenham, London, N.17.

News of the Week

Current Events in Brief Review

Radio in Russian Hotel

IN the new Soviet Hotel, Moscow, each room will be connected to a central radio distribution board, enabling listeners to enjoy a choice of programme.

Factory at Radio Show

A MODEL factory, employing 250 workers, will be set up at the Berlin Radio Show to enable the public to watch the manufacture of the "People's Receiver" from start to finish.

Short Waves for the People

WE learn that a "People's Short-Wave Receiver" will soon be launched in Germany on the lines of the famous "Volksempfänger." The set will be designed to compete in quality and price with foreign makes.

A Pinhead Set

IT had to come. Mr. Rufus P. Turner, of Waltham, Mass., has constructed a wireless receiver upon the head of an ordinary pin.

Belfast Wireless Week

BELFAST is to "go wireless" during the first week in October, when the annual Radio Exhibition takes place in the King's Hall.

A special theatre capable of seating up to a thousand people will be built on the large verandah of the building and broadcast variety programmes will be presented.

Ultra-Short Wave Puzzle

ANNOUNCERS at WNEW Newark, U.S.A., were mystified recently on hearing orchestral

A Hundred Years Hence

PROMINENT American radio personalities, invited by the U.S. journal *Radio Guide* to discuss radio a hundred years hence, have written as follows:—

Dr. Lee de Forest:—"There will be a complete revolution in the manner of providing broadcasts. Certain stations will always send the same kind of material so that the listener may know exactly where to choose his entertainment. All programmes will be entirely devoid of advertising and high-powered announcers, who by then will assuredly have died out!"

Dr. Alfred N. Goldsmith, former Chief Engineer of the Radio Corporation of America: "Rising from my breakfast in June, 2034,

5-metre Tests at Malvern

5-METRE tests are to be conducted, circumstances permitting, on the Malvern Hills, Worcestershire, on Sunday next, from 11 a.m. to 6.30 p.m. The transmitters are G5FI and G6YJ. Both telephony and I.C.W. will be used. Reports of reception and contacts with other amateur stations will be welcomed by G5FI, Cefn Coed, Brecon.

Roman Catholic Station for Ireland

THE approval of the Irish Free State Government is said to have been secured in connection with the suggested Roman Catholic broadcasting station for Ireland. The station would be used to provide programmes of Catholic interest relayed from the Vatican and others originating in its own studio.

New U.S. Radio Control

THE American Federal Communication Commission, which replaced the Federal Radio Commission on July 1st, will have an engineering staff of 300. The new Commission exercises jurisdiction over all kinds of radio and cable communication in America including broadcasting.

A Transmission Record?

THE Prangins short-wave station of the League of Nations recently sent out a radiogram of record length. It transmitted in English and Spanish to all Governments of the American Continent, the report of the Chaco Commission. Transmission began at 11.30 p.m., was interrupted at 4 a.m., was resumed at 10 a.m., and finished at 6 p.m. The Buenos Aires station received the entire text, but Le Paz had to demand a repetition of some of the passages.

U.S. Amateur Restrictions Raised

AN old fear that short-wave radio stations operated under the guise of amateur transmitters, might be used in rum-running operations, has subsided with the passing of Prohibition in America. One of the last acts of the Federal Radio Commission before its expiry at the end of June was to relax the rules for licensing amateur portable stations. The Commission has also relaxed amateur and experimental station rules so as to permit any such station to use the ultra-short waves above 110,000 kc/s.

Bristol Radio Show

THE Bristol and West of England Radio and Home Entertainments Exhibition is to be held at the Colston Hall, Bristol, from September 24th to the 29th. Nearly all the available space has already been booked.

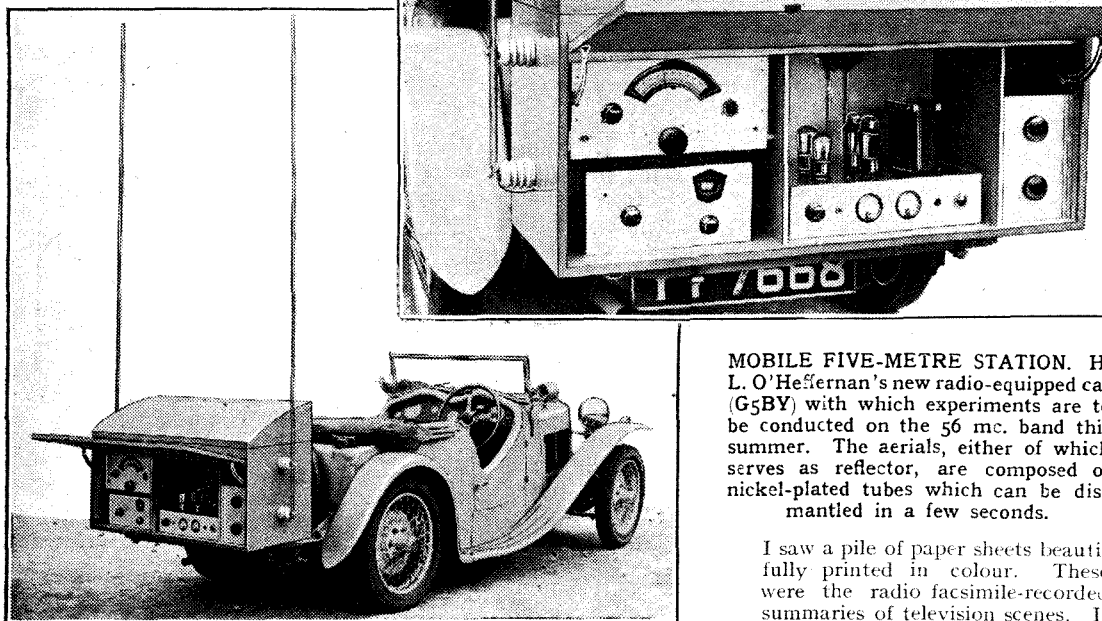

MOBILE FIVE-METRE STATION. H. L. O'Hearn's new radio-equipped car (G5BY) with which experiments are to be conducted on the 56 mc. band this summer. The aerials, either of which serves as reflector, are composed of nickel-plated tubes which can be dismantled in a few seconds.

I saw a pile of paper sheets beautifully printed in colour. These were the radio facsimile-recorded summaries of television scenes. If I miss events of the day by television, I can review them in facsimile."

Dr. O. H. Caldwell, former Federal Radio Commissioner: "Radio will be used to heal the body and to produce a kind of intoxication, therefore making it necessary to frame laws against radio drunkenness. In a hundred years, radio may have solved the riddle of Life itself."

Broadcasting from Greece

PLANS for the new broadcasting station in Athens include a concert hall with seating accommodation for 2,000.

The British company which has tendered for the erection of the station undertakes to advance the capital required, which would eventually be repaid from licence receipts and admission fees to the concert hall.

Music Underground

PASSENGERS at the Chatelet station on the Paris Metropolitan railway were agreeably surprised a few days ago on hearing a concert of music followed by news bulletins from loud speakers fitted in the roof. It is understood the railway intends to use such entertainment as a permanent attraction for travellers, who might otherwise take a 'bus or taxi.

Algiers Learns a Lesson

RADIO ALGIERS, it appears, has been killing the goose that lays the golden egg. In other words, there has been too much radio advertising, and listeners are either protesting or abandoning their receivers. In consequence, a State subsidy has been allotted which should enable the authorities to make an appreciable reduction in the number of "puff" announcements.

music proceeding from a microphone in the studio. It was discovered that the microphone was picking up the transmissions from the 5-metre station on the Empire State building in New York.

New French Radio Orchestra

LISTENERS to Radio Paris have been impressed by the new French National Radio Orchestra conducted by M. Inglebrecht.

Our Paris correspondent recently attended a special concert to display the attainments of the new orchestra, and writing as an observer in the studio, says: "The performance justifies the hope that this orchestra may soon occupy the first place among French musical combinations. In its rendering of the finest shades of expression the orchestra was impeccable and responded to its conductor with 'solo' suppleness."

BROADCAST BREVITIES

By Our Special Correspondent

A Clean Start

DAVENTRY National is to die a sudden death. The intention, I understand, is to make a clean, quick start with the new Droitwich transmitter, there being no attempt to "fade in" the station over a period of weeks as in the case of the Regional transmitters.

Royal Visit to Droitwich?

But for the intervening holiday, a member of the Royal Family would have been invited to the opening ceremony on September 6th. Now it appears likely that some of the Governors, with the Director-General of the B.B.C., will be the chief functionaries. A royal visit will probably take place later in the year.

The transmitter will actually be working on Thursday, September 6th, during the Press visit, and it is now considered likely that the station will permanently take over on the Sunday following, September 9th.

A New Empire Station

What will happen to the obsolete Daventry transmitter? Even the engineers will grow sentimental when dismantling a station which has given nine years faithful service. It was opened on July 27th, 1925.

I can now reveal that some of the gear will be incorporated in the new Empire station which Mr. Ashbridge proposes to build in the not far distant future. The two short-wave transmitters at present serving the five Zones of Empire are now found to be insufficiently powerful, although they have been functioning only eighteen months. Plans are in hand for reconstruction with twice or thrice the present power of 50 kW.

Programmes Are Good, but . . .

This should be good news for the Colonies. As "Megacycle" has already pointed out in *The Wireless World*, the Daventry programmes are held in high esteem, which makes it all the more tantalising when, technically speaking, the transmitter cuts a poor figure beside the short-wave stations of France, Germany and Holland.

St. George's Hall

THE B.B.C. is tightening its hold on St. George's Hall, which, it seems, is to become a permanent broadcasting establishment. New microphone and telephone points are to be installed to improve inter-communication between the orchestra, conductor, producer, artistes and the Balance and Control section.

While the new wiring is in progress, from July 15th to the 22nd, no broadcasts will take place from the hall.

Better Acoustics

Next winter ambitious redecoration schemes are to be attempted. The acoustics will be improved, but the theatre atmosphere will be retained.

More Room

Although it is a comparatively old building, the Light Entertainment staff find the offices there much more congenial than those across the road.

Their abdication from former quarters in



POSTE PARISIEN EN FETE. For the first time in its history, the popular French station recently permitted the public to view broadcasting in progress. The photograph was taken at the radio show in the *Salon des Portiques*, Avenue des Champs-Élysées, during a transmission.

Broadcasting House has given the Talks branch room to expand. There is also more space available for the new Empire publicity section functioning in the Press department.

Welsh Rare Bit

IT has become a tradition for the Right Hon. D. Lloyd George to be present at the Chairing of the Bard ceremony in the Royal National Eisteddfod of Wales, which will be held this year at Neath from August 6th to 11th. The chairing ceremony on August 9th will be relayed on the National wavelengths. Welsh poets all struggle for this blue riband of Welsh literature. The bardic honour goes to the writer of the best ode in Welsh metre.

Applause from the Gallery

Although we may not all understand the language, some of the enthusiasm should be communicated over the ether, for there will be probably 20,000 spectators whose reactions to the poem should make for good listening.

Broadcasting the Empire Games

FOUR years ago the first Empire games were held in Canada and, by reason of their success, it was decided to continue them at intervals of four years. They will be held this year in London next month. The athletic events will take place at the White City, and Mr. H. M. Abrahams, well-known Olympic athlete, will describe some of the leading events in the National programme on August 4th.

It is possible that some of the events, such as a marathon relay race, boxing, wrestling and swimming matches, may be described in separate broadcasts. Work on the magnificent new swimming pool at Wembley is being pushed on so that the swimming events may be held there.

The Malvern Festival

THIS year's Malvern Festival opens on July 23rd with a new play by John Drinkwater called "A Man's House." It is described as having "a theme which is universal, though of special significance to-day when the world is slipping back beneath political dictatorship."

F. R. Buckley, film critic, will give Midland Regional listeners his impressions of the first night of the play

"Mr. Pim Passes By"

IRENE VANBRUGH will broadcast on July 25th (National) and 26th (Regional) when she takes her original part of Olivia in A. A. Milne's comedy, "Mr. Pim Passes By." During a season in Manchester in 1919 Miss Vanbrugh created this part in the first performance of the play, which was brought to London in the following year and put on at the New Theatre, with Miss Vanbrugh again as Olivia. She subsequently played the same rôle when "Mr. Pim Passes By" toured South Africa.

Henry Hall's Holiday

CURIOSITY-MADDENED readers will not drag from me the name of the south coast resort at which Henry Hall proposes to spend a holiday out of the limelight. Suffice it to say that the neighbourhood is famous for the breeding and training of racehorses.

Les Allen, the B.B.C. Dance Band vocalist, will be away at the same time, sailing for Toronto on August 28th. He will be away five weeks, and during his absence his deputy will be another Canadian, Charles FitzGerald, also of Toronto.

"Gerry," as he is called, will make his bow to British listeners in Henry Hall's Guest Night to-morrow, July 14th.

THESE columns are reserved for the publication of matter of general interest arising out of problems submitted by our readers. Readers requiring an individual reply to their technical questions by post are referred to "The Wireless World" Information Bureau, of which brief particulars, with the fee charged, are to be found at the foot of this page

Readers' Problems

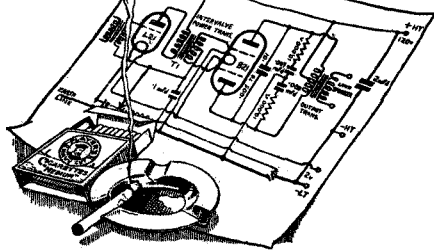

Calculating Amplification

REFERRING to the Quality Push-Pull Amplifier recently described in this journal, a reader finds that the published figures for the amplification of the first stage do not correspond with his own calculations.

This discrepancy is accounted for by the fact that our correspondent has apparently taken the rated impedance of the valves as a basis. By agreement among manufacturers, the A.C. resistance of valves is nearly always quoted at zero bias, but in actual working the value is nearly always higher, as negative bias is employed.

In addition, the discrepancy is further increased by the fact that in ascertaining the effective value of the coupling resistance it has been forgotten that the grid leak is virtually in parallel with the anode-circuit resistance.

Disturbing Tuning

IN spite of warnings which have been published it would appear that a good many amateurs are inclined to follow the line of least resistance, and when inserting a milliammeter in the anode circuit of a screen-grid H.F. or I.F. valve to wire the instrument between the anode cap terminal and the existing connection.

A correspondent, who has followed this easy but generally unsatisfactory plan in connecting a meter to an I.F. valve (of which the bias is controlled by the A.V.C. system), finds that the set is less sensitive and selective than before the meter was connected. We are asked to explain why this should

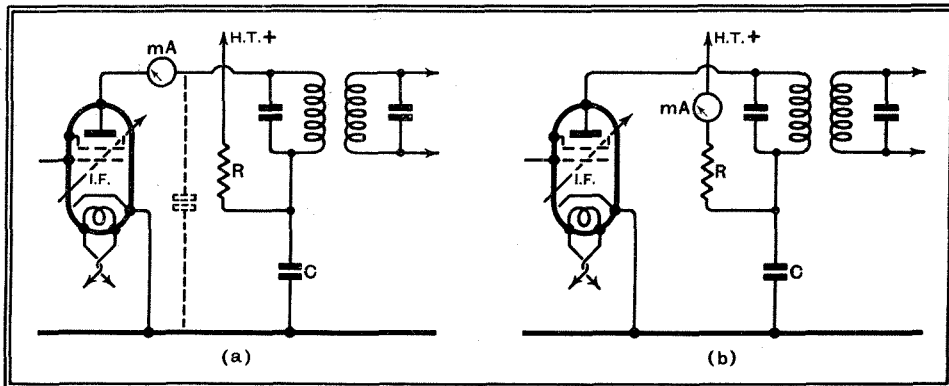

Fig. 1—Incorrect and correct positions for a milliammeter. R and C are decoupling resistances and condensers.

be; the trouble of instability, which it was anticipated might occur, has not arisen.

It is probable that the capacity of the meter and its connecting leads to earth has disturbed the tuning of the I.F. transformer; the possibility of this occurrence will be made clear by reference to Fig. 1 (a), where the added capacity of the meter, shown in dotted lines, is effectively in parallel with the transformer primary tuning condenser.

The safe rule is that an anode-current measuring instrument should always be connected at the low-potential end of the circuit, in the position marked in Fig. 1 (b).

Carrier-borne Hum

MODULATION hum (hum which only becomes audible when the carrier wave is tuned-in) should not normally occur in a properly constructed Single-Span receiver. We recommend that a reader who has encountered this trouble should examine his earth connection; a defective "earth" is the most probable cause.

Excess Voltage L.T. Source

SEVERAL queries have lately been received concerning the use of 6-volt and 12-volt batteries as sources of filament current supply. One of these letters deals with the question of obtaining as well as a suitable bias voltage for a small output pentode from the same battery.

Assuming that the valve filaments are to be connected in parallel across the battery, with a limiting resistance in series, the best way of obtaining free bias will probably be to make use of the drop in voltage across this resistance, as illustrated in Fig. 2. In the case under discussion, 2-volt valves are to be fed from a 12-volt battery, and so 10 volts will be developed across the resistance; any desired proportion of this voltage may be "picked off" by making the grid circuit

safer "series" system, which, so far as battery valves are concerned, at any rate, generally introduces such complications as "by-pass" resistances, etc.

It cannot be denied that this danger exists, for the reason that if one of the valves be burnt out, removed from its socket, or even if a temporary interruption should occur in one of the filament circuits, there will be a risk of burning out all the remaining filaments. This is because the voltage absorbed in the limiting resistance will be reduced as a result of the lessened current demand, and so a higher voltage will be applied to the filaments of the remaining valves.

In spite of this disadvantage, a parallel form of connection is often preferred to the

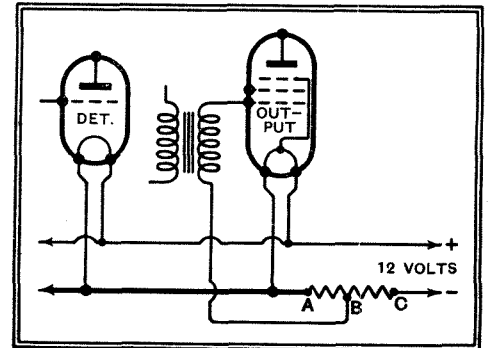

Fig. 2.—Low-tension and grid bias voltage from a car accumulator.

safer "series" system, which, so far as battery valves are concerned, at any rate, generally introduces such complications as "by-pass" resistances, etc.

Counting the Cost

IN order to arrive at the running cost of an A.C. mains receiver it is necessary to ascertain the wattage dissipated in the primary winding of the power transformer. A correspondent who asks for information on this subject will find that a sufficiently accurate estimation may be made by totaling the wattages delivered by the various secondary windings (H.T. and L.T.), and then adding about 25 per cent. for the losses in the transformer.

With regard to the L.T. secondaries which feed the receiving and rectifying valve heaters, no difficulty will be experienced, as the total is easily arrived at by adding together the heater ratings of the various valves. As far as H.T. consumption is concerned, it will be sufficiently near to the mark, in the absence of precise information, to consider the A.C. current and voltage as being equal to the rated maximum output of the rectifying valve.

The Wireless World INFORMATION BUREAU

THE service is intended primarily for readers meeting with difficulties in connection with receivers described in *The Wireless World*, or those of commercial design which from time to time are reviewed in the pages of *The Wireless World*. Every endeavour will be made to deal with queries on all wireless matters, provided that they are of such a nature that they can be dealt with satisfactorily in a letter.

Communications should be by letter to *The Wireless World* Information Bureau, Dorset House, Stamford Street, London, S.E.1, and must be accompanied by a remittance of 5s. to cover the cost of the service.

Personal interviews are not given by the technical staff, nor can technical enquiries be dealt with by telephone.

return connection to the appropriate point. Referring to the diagram, it will be clear that if this connection were made to point A there would be no bias, as the grid is then at the same potential as the negative end of the filament. Full bias of 10 volts would be obtained by joining the lead to point C, while 5 volts would be applied as a result of making connection to the centre point of the resistance at B—other voltages from 0-10 volts in proportion.

Another question deals with the danger of connecting a number of filaments in parallel across a source of comparatively high

Sunbeam "Midget"

A Remarkably Compact Superhet with A.V.C.

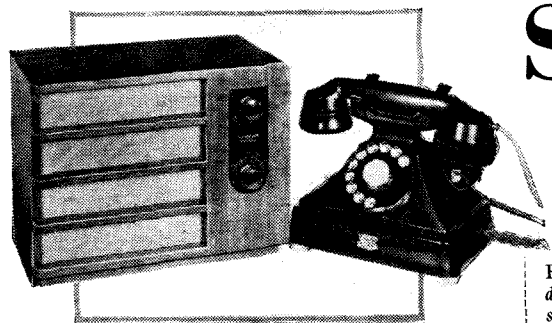

MODEL 22

FEATURES. Type.—Midget superheterodyne receiver with A.V.C. and moving-coil loud speaker. **Circuit.**—H.F. pentode frequency changer—variable-mu pentode I.F. amplifier—duo-diode-pentode detector and output stage. **Low impedance half-wave rectifier. Controls**—(1) Tuning. (2) Volume control and on-off switch. (3) Waverange. **Price.**—9 guineas. **Makers.**—Sunbeam Electric Ltd., Park Royal Road, London, N.W.10.

THERE must be a very wide section of the listening public for whom the process of acquiring a wireless receiver is much the same as that of ordering the installation of the telephone. Their interest does not lie in searching for distant and difficult stations to receive, but in being able to switch on for the time signal, the news bulletin and the occasional diversion of dance music. A large cabinet occupying a prominent position would be quite out of keeping with the part played by the receiver in the scheme of things. What is really required is a small neat instrument as readily accessible and as unobtrusive as the telephone.

This is precisely what Sunbeam Electric, Ltd., have produced in their latest "Model 22" receiver. The cabinet measures only 11in. x 8½in. x 6in., and the controls have been simplified to the fullest possible extent. There is a small tuning knob approximately calibrated in wavelengths, and a combined mains switch and volume control. The remaining control—the waverange switch—is fitted in the right-hand side of the cabinet.

The quality of reproduction is really surprisingly good, and, while it would be too much to expect any real bass response, there is yet sufficient simulation of bass to remove any serious suggestion of deficiency in that direction. Speech is excellent, and the quality in general is characterised by crispness.

The set was tested in a steel-framed building at fifteen miles from Brookmans Park, and due to the effect of screening the volume obtained on the indoor aerial provided was hardly sufficient to do justice to the capabilities of the set. On the standard outdoor aerial, however, an ample reserve of volume was obtained, and the control was turned

down by a third on the National and two-thirds on the Regional programme. The long-wave sensitivity was good, and no difficulty was experienced in receiving Radio Paris clear of interference.

Second channel and I.F. interference was absent, and mains ripple on both D.C. and A.C. mains negligible. There was, however, a good deal of mains pick-up noise on the indoor aerial owing to the fact that under the conditions prevailing the carriers of the local stations were not sufficient to operate the A.V.C. and so reduce the overall sensitivity of the set. For this reason it is advisable to use as efficient an aerial system as circumstances permit.

The valves used in the set are of the indirectly-heated universal type, the heaters being connected in series with a resistance incorporated in the mains lead. A tapping is provided to adjust the resistance to voltages between 200 and 250 volts, and the set may be plugged either into D.C. or A.C. mains from 25 to 100 cycles. The half-

wave rectifier is of the type in which the two anodes of a full-wave rectifier are connected in parallel, thus giving a low internal resistance. The loud speaker field is connected directly across the rectifier output, and a separate choke and electrolytic condensers are used for smoothing. Incidentally, the loud speaker is provided with a hum-bucking coil which results in a minimum of mains ripple.

A single tuned circuit loosely coupled to the aerial precedes the first valve, and sub-

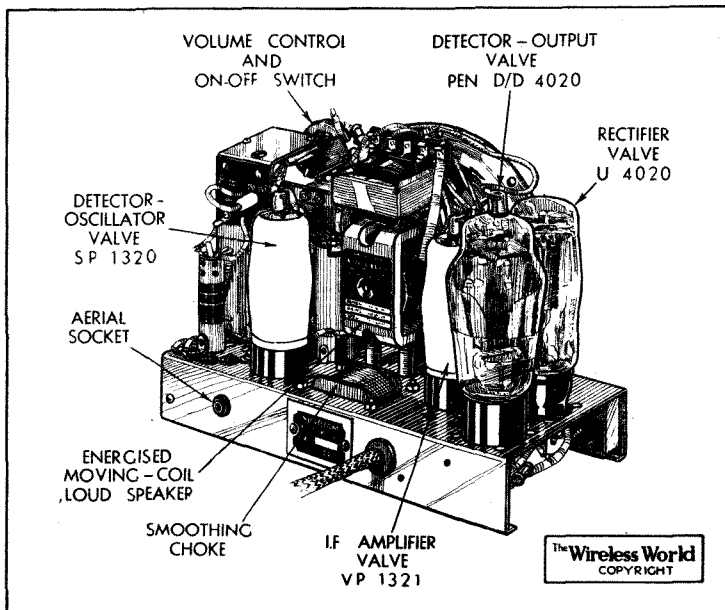

The compact dimensions of the chassis may be judged from the size of the indirectly-heated universal valves.

sidary retractor circuits are included to reduce second channel and I.F. interference. The frequency changer, like the I.F. amplifier, is an H.F. pentode, the I.F. valve being of the variable-mu type. There are two I.F. transformers, both primary and secondary being tuned in each case. The third valve combines the functions of detector and output valve, and is of the duo-diode pentode type. The diodes are connected in parallel, and A.V.C. bias from

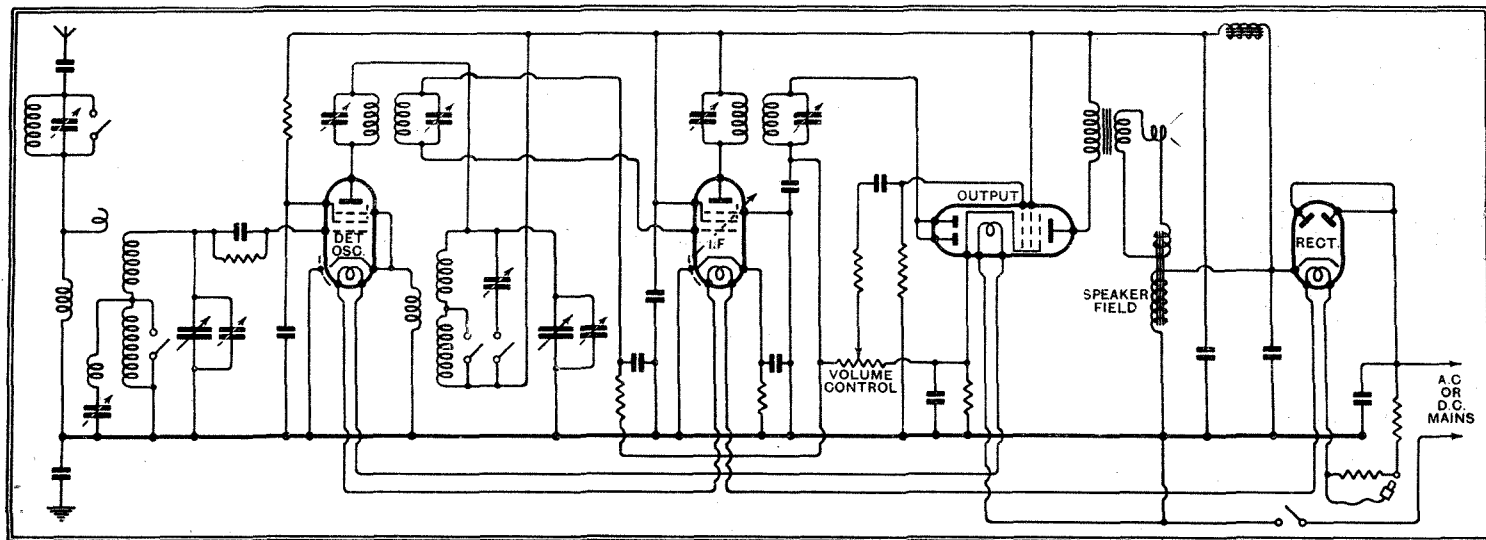

Complete circuit diagram. The functions of detector and output valve are combined in the third stage of the receiver.

Sunbeam "Midget"—

the diode load resistance is applied to the grid of the I.F. stage.

The cabinet is built of solid walnut and is very carefully made, the "egg-shell" finish being well suited to the general design.

This is the set *par excellence* for the modern one-room flat, for with its efficient circuit it can be relied upon under normal conditions to give reliable service with the short indoor aerial provided, while its small size and neat appearance will fit in with the most carefully planned furnishing scheme.

Letters to the Editor

The Editor does not hold himself responsible for the opinions of his correspondents

A Frequency Scale Interval Signal

THE B.B.C. go to great pains in their endeavours for quality transmissions, and I feel that they have a moral responsibility to help listeners to obtain quality reception. The transmission of a "frequency scale," as has been suggested in *The Wireless World*, would show listeners what quality they are actually obtaining from their apparatus, for huge numbers of people seem to have very queer ideas as to what good reproduction means, but if by this simple means they were shown what good reproduction they were *not* getting they would be encouraged to improve their receivers.

A "frequency scale" could easily take the place of the present interval signal, thus making this unfortunate necessity of greater importance, for in any case it could not become any more monotonous than Bow Bells or the clock tick.

Hoping that a strong demand through *The Wireless World* will at last give us the transmission that we have needed for so long a time.

G. F. DAY.
H.M.S. Windsor.

Empire Views on the B.B.C.

IN your issue of May 25th, under the heading of "Broadcast Brevities," your special correspondent writes:—

"Whatever happens, a lot will depend upon the attitude of the Empire Broadcasting organisations. At present their attitude to the B.B.C. is anything but complimentary, the feeling being that nothing that Daventry short-wave has yet offered has justified a cessation of the local programmes in favour of those from the Mother Country."

As members of the Radio Club of Ceylon and South India, one of the earliest radio clubs in the Empire (founded in 1922, present membership over 500), may we ask your correspondent to exclude Ceylon and South India from his generalised statement that the attitude of the Empire Broadcasting organisations is anything but complimentary to the B.B.C.?

We are sure that the actual situation in Ceylon and South India—and we are certain the Colombo Broadcasting Authorities will be able to confirm this—is entirely the reverse of what your correspondent suggests, and there is nothing but praise for the efforts of the B.B.C. to provide programmes suitable for the varied needs of the Empire.

Surely, also, your correspondent is hardly accurate in suggesting that the Empire programmes were ever intended to replace "local" programmes in the Colonies. We are certain there has never been any such intention, at least, in Ceylon and South India.

The "local" programmes are obviously the basis of all broadcasting in any given

area, but these can be made vastly more attractive by the relaying of part of the Empire transmissions from Daventry, as is now the practice from Colombo Broadcasting station nearly every night of the week.

F. J. HOLLOWAY, Vice-president.
J. S. H. JOLLIFFE, Committee Member,
Radio Club of Ceylon and South India.
J. S. DINWIDDIE, late Editor, Ceylon
Radio Times, published by the Radio Club
of Ceylon and South India.

The Question of Quality

I WAS much interested by your Editorial Comment of June 8th, as from the earliest days of broadcasting the question of quality of reproduction has appealed to me more than that of distance, and I have found much good sport in tracking down resonances.

My answer to your question, "Does the Public Really Care?" would be an unhesitating "Yes," with the proviso that "the public" rarely gives this answer in such a direct and simple form.

With a fairly decent set, response reasonably level between 70 and 5,550 cycles, and with no markedly audible resonances, I have tried, during the last three years, to analyse the reactions of that portion of "the public" which comes within range of my loud speakers. There are some difficulties in this task—the desire of the listener to gratify the vanity of the set owner, and also his fear of committing himself—but a suitable appeal to each hearer will often produce a frank comment.

The set has two loud speakers, a 9in. diaphragm moving coil for the lower register, and a Primustatic for the upper, with a potentiometer tone control. This control gives no indication of its setting visible from the outside of the set, and it is very interesting to ask a hearer to set this control to suit his own taste.

The most frequent comment has been, "Where can one get a set like that?" sometimes varied by, "Why can't one?" Another common one was, "How natural it sounds"; another (four times), "Oh, I thought there was someone in the room; it doesn't sound like wireless."

Other cases of some interest were:—

Two musicians who have both been reproduced by the set, *via* the B.B.C.; the younger one dislikes wireless, and does not listen; the older one listens gleefully, and points out that there are beauties even in jazz.

The owner of a good battery portable, who dislikes listening except to the news, said, "Oh, I don't mind listening to your set; you always keep it so quiet." As the sound output was then two or three times the maximum available from her set, it would seem that "quiet" may be a lay term for distortionless.

The results of asking people to set the tone control for themselves was a little unexpected. Of fifteen persons, four of whom were artisans and five were people who had had some definite musical instruction, only three produced settings differing, and then only by a very little, from the "normal." This "normal" was a point marked inside the set with the kind help of a notable pianist, while listening to a piano solo from the B.B.C. Of these three variations two accentuated the upper register, and one the lower.

The low setting was given by the owner of a set in which the use of reaction cuts out much of the high register, and has a bass resonance; he remarked that his own set starved him of those beautiful low notes. I take this as showing that a bass resonance is no substitute for bass notes. Putting the same point in another way, I would say that the behaviour of a set to transients in the bass register requires special attention.

As to the question of "mellow tone," I find that people can stand it astonishingly well, until they have heard a truer reproduction alongside; then they insist on the latter. Any shrillness due to the production of harmonics by overloaded valves or other causes sends them back immediately to the mellow tone. I suspect the third harmonic as the worst offender.

Generalising, then, from a very small basis, I believe that "the public" does care, that it does not much mind giving up a little of the upper register to secure advantages in other directions, that it hates false resonances and false harmonics, and that it delights in hearing the percussion of the percussion instruments of the orchestra.

B.B.C. transmissions of standard audio-frequencies would certainly help us to improve our quality of reception, but a good piano solo transmission is suitable for this purpose.

Please note that I make no claim to remarkable quality in my set. It is good, but not so good that . . . When valve makers and others think more of D.C. users it will, I hope, improve, and always with the help of the W.W.

ROBERT VENABLES.

Chiswick.

What is a Radio Engineer?

IF "Unchartered Radio Engineer" will turn to the last page of *The Wireless World* issue of June 15th he will see an announcement of the Institute of Wireless Technology. This institute, though still in its infancy, is the wireless equivalent to the I.E.E.

A glance through the past examination papers of this institute will suffice to show that no "Quack" radio engineer could gain admittance to its membership. Moreover, a successful candidate may not designate himself Assoc.I.W.T. or A.M.I.W.T. until he has had three years' practical experience.

Faced with these facts, "Unchartered Radio Engineer" must admit that any form of membership of this institute is an equivalent qualification to the corresponding membership of the I.E.E.

ANTONY CHADWICK,

Student Member of the I.W.T.

Coventry.

Correspondence, which should be as brief as possible, should be addressed to the Editor, "The Wireless World," Dorset House, Stamford Street, S.E.1, and must be accompanied by the writer's name and address.

MAGNAVOX

LATEST *and* GREATEST
ACHIEVEMENT

DOUBLE SIX

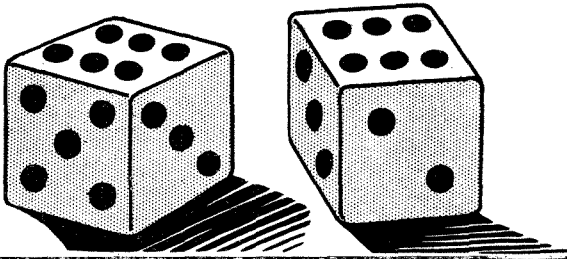

The first Magnavox Moving Coil Loudspeaker was made in 1911. Since then, Magnavox, as pioneers in Moving Coil Speaker design and construction, have consistently led the way and have established a standard to which all others aspire, but few attain.

The **“DOUBLE-SIX”** *is unbeatable!*

The Magnavox Double-Six Speaker represents the accumulated experience of over 20 years in Loudspeaker design, construction, and practice and sets an entirely new standard in mechanical reproduction.

It is one of those extremely rare productions where superlatives of the highest order could be legitimately used in describing it.

We do not wish however to encroach on the users' privilege—they will use all the superlatives necessary when they hear and see the Double-Six!

Not long to wait—only another week!

Look for the Magnavox full-page next week, which will give some interesting technical details.

**RELEASE
DATE
JULY 20th**

SETS a NEW STANDARD in FIDELITY

THE BENJAMIN ELECTRIC LTD, BRANTWOOD WORKS, TOTTENHAM. N.17. 8

MISCELLANEOUS ADVERTISEMENTS

NOTICES.

THE CHARGE FOR ADVERTISEMENTS in these columns is

12 words or less 3/- and 3d. for every additional word.

Each paragraph is charged separately and name and address must be counted.

SERIES DISCOUNTS are allowed to Trade Advertisers as follows on orders for consecutive insertions, provided a contract is placed in advance, and in the absence of fresh instructions the entire "copy" is repeated from the previous issue: 13 consecutive insertions 5%; 26 consecutive, 10%; 52 consecutive, 15%.

ADVERTISEMENTS for these columns are accepted up to **FIRST POST ON MONDAY MORNING** (previous to date of issue) at the Head Offices of "The Wireless World," Dorset House, Stamford Street, London, S.E.1, or on **SATURDAY MORNING** at the Branch Offices, 19, Hertford Street, Coventry; Guildhall Buildings, Navigation Street, Birmingham. 2; 260, Deansgate, Manchester, 3; 26a, Renfield Street, Glasgow, C.2.

Advertisements that arrive too late for a particular issue will automatically be inserted in the following issue unless accompanied by instructions to the contrary. All advertisements in this section must be strictly prepaid.

The proprietors retain the right to refuse or withdraw advertisements at their discretion.

Postal Orders and Cheques sent in payment for advertisements should be made payable to **ILIFFE & SONS Ltd.**, and crossed **& Co.** Notes being untraceable if lost in transit should not be sent as remittances.

All letters relating to advertisements should quote the number which is printed at the end of each advertisement and the date of the issue in which it appeared.

The proprietors are not responsible for clerical or printers' errors, although every care is taken to avoid mistakes.

NUMBERED ADDRESSES.

For the convenience of private advertisers, letters may be addressed to numbers at "The Wireless World" Office. When this is desired, the sum of 6d. to defray the cost of registration and to cover postage on replies must be added to the advertisement charge, which must include the words Box 000, c/o "The Wireless World." All replies should be addressed to the Box number shown in the advertisement, c/o "The Wireless World," Dorset House, Stamford Street, London, S.E.1. Readers who reply to Box No. advertisements are warned against sending remittance through the post except in registered envelopes; in all such cases the use of the Deposit System is recommended, and the envelope should be clearly marked "Deposit Department."

DEPOSIT SYSTEM.

Readers who hesitate to send money to advertisers in these columns may deal in perfect safety by availing themselves of our Deposit System. If the money be deposited with "The Wireless World," both parties are advised of its receipt.

The time allowed for decision is three days, counting from receipt of goods, after which period, if buyer decides not to retain goods, they must be returned to sender. If a sale is effected, buyer instructs us to remit amount to seller, but if not, seller instructs us to return amount to depositor. Carriage is paid by the buyer, but in the event of no sale, and subject to there being no different arrangement between buyer and seller, each pays carriage one way. The seller takes the risk of loss or damage in transit, for which we take no responsibility. For all transactions up to £10, a deposit fee of 1/- is charged; on transactions over £10 and under £50, the fee is 2/6; over £50, 5/-. All deposit matters are dealt with at Dorset House, Stamford Street, London, S.E.1, and cheques and money orders should be made payable to Iliffe & Sons Limited.

SPECIAL NOTE.—Readers who reply to advertisements and receive no answer to their enquiries are requested to regard the silence as an indication that the goods advertised have already been disposed of. Advertisers often receive so many enquiries that it is quite impossible to reply to each one by post. When sending remittances direct to an advertiser, stamp for return should also be included for use in the event of the application proving unsuccessful.

Set Manufacturers' Surplus, Clearance and Bankrupt Stocks offered in any of these columns may not be Manufacturers' current lines. Radio components advertised at below the list price do not carry any manufacturer's guarantee.

RECEIVERS AND AMPLIFIERS, ETC.

- L. EASTWOOD** Sound System.
- R**EPRODUCTION that is Almost Perfect.
- T**YPE R.62 2-stage Resistance Coupled Amplifier, having 6-watt Pentode in output stage, supplied in steel case complete with B.V.A. valves, suitable for small dance halls and cafes, etc.; price 12 guineas.—Write Dept. A.
- 70**, Pitfield St., N.1. Clerk, 7693. [6073]
- C**OMPULSORY Sale of Brand New Goods.
- Z**ETAVOX 8v. A.C. Superhets. A.V.C., 1 year guarantee, £8.8 table; £9.9 console.
- 4**v. A.C. Superhets, designed by Wearite; £6.
- 3**v. Battery Band-Pass, Rola, no valves, Lotus copy; 50/-.
- 4**v. Battery Band-Pass Rola, no valves; 60/-.
- A**MERICAN Valves, 247, 245, 227, 224, 235; 4/- each. Warren, 38, Inglis Rd., Ealing Common, London. [6098]
- H**AYNES' Latest Duophase Superhet Chassis, unused, 2 P.X.25 output, £21; dual Magnas, £3; together £23.—Gerrard 4622.
- M**ARCONI 60 Watt A.C. Amplifier, type P13, 110-250v., suitable for microphone, gramophone, or radio, in polished oak cases, complete with valves; £12/10 each.
- I**GRANIC 60 Watt A.C. Amplifier, 110-250 volts, metal chassis, complete with valves; £12/10.
- G**.E.C. P.A., 60 Watts, in teak cases; last few to clear, £2/10, components worth double!!!
- A**MPLION Exponential Horn Type Speakers, in water-tight cases, 6 volt field, £5; 230 volt A.C., £5/15.
- L**ARGE and Varied Stock of P.A. Amplifiers, microphones, speakers, converters, heavy duty chokes, transformers, meters, condensers, etc.; stamp for lists and prices; callers invited.
- H. FRANKS**, 23, Percy St., Tottenham Court Rd., W.1. Museum 8585. [6089]
- 4**-VALVE Superhet Midgets 1935 models, A.C. or D.C., M.C. speaker, £3/19/6; 5-valve, £5/5, including valves; c.o.d.; write catalogue.—Royal, 5, Buckingham Rd., London, E.18. [5939]
- P**UBLIC Address Amplifier, A.C. 3-stage, 15 watts undistorted output, complete valves, 2 horn speakers, moving coil microphone, twin turntables; £50, or nearest.—260, Borough Rd., Birkenhead. [6037]
- F**ERRANTI "Gloria" 1934-35 Superhet., £23/2; 16 guineas; before purchasing a new receiver elsewhere, send for details of unprecedented offers.—Bankrupt Stock, 151, Wellington Rd., Northampton. [6096]

"Eclipse" 4S TOOL
for
SLOTTING
SAWING
SCRAPING
SLITTING
FILING, ETC.

SAWING BLADES
SLITTING BLADES
SCREWDRIVER BLADE
SLITTING ANVIL
TAKE ROUND SCRAPER
FLAT SCRAPER
FILE

Invaluable for
101 JOBS IN
ENGINEERING
ELECTRICAL
GARAGE and
GENERAL
MAINTENANCE
WORK

Complete Outfit
16 Tools with
Patented Holder
in Metal Case
5/-

Obtainable from all Tool Dealers

Made by the Manufacturers of
ECLIPSE HACK SAW BLADES & FRAMES

JAMES NEILL & CO. (SHEFFIELD) LTD., SHEFFIELD 11
E.456

Receivers and Amplifiers, Etc.—Contd.

- A**RMSTRONG.—Latest 6-stage superheterodyne chassis, Heptode frequency changer, A.V.C., £6/18/6, including Marconi valves, Royalties paid; Armstrong 3-pentode, 4-valve chassis, full band pass, £5/18/6, including valves.
- A**RMSTRONG.—Universal chassis, band pass, 3-tuned circuits; £5/18/6, including valves; any chassis 7 days' trial.—Armstrong Co., 100, King's Rd., N.W.1. [6051]
- £4/10**—200-250 A.C. band pass S.G.3, in attractive walnut case similar to Lotus, complete with valves and Rola M.C. 3 gang Radiophone, screened coils, listed £10/10, brand new; ditto table radiogram, Simpson turntable, Belling Le; pick-up, complete; £5/15.
- 55/-**—S.G.3 band pass battery receiver, as above, with P.M. Rola or Sonochord (without valves, batteries), listed £8.8; similar set S.G.3, 2-gang Polar, Ormion loud speaker, in identical cabinet, for 42/6; all c.o.d., carriage forward.—Kay, 167, City Rd., London, E.C.1. [6093]
- O**UR Kit for "Wireless World" Quality Amplifier complete in every detail, including valves, amplifier only, £8/10; feeder unit, 36/-; carriage paid; cash with order or c.o.d. send for detailed list of components.—Ward, 2nd Floor, 45a Farringdon St., London, E.C.3. Holborn 9705. [5760]
- P**UBLIC Address Amplifiers.—A.C. mains, three stage, 21 watts, undistorted A.C. output, complete with valves, £15; universal A.C./D.C. three stage, 7 watt output, complete, £13; guaranteed 12 months; trade supplied; deferred terms.—D. E. Clarkson, B.Sc. (Eng), 45, Manor Rd.; Wallington, Surrey. 'Phone: Wallington 3953 [6046]
- M**IDGET All-mains Receivers, brand new, ideal for travellers, etc., operating any voltage, A.C./D.C., 100-240, Emerson 5-volt, figured walnut cabinet (10x7x5 1/2), M.C. speaker, pick-up terminals, list 10 guineas, at £4/6.3 complete; few only as above, less cabinet, suitable incorporating in own cabinet, £3/14; carriage paid; cash with order or c.o.d.—Degallier's, 4, Croyton House, 21, Upper Marylebone St., London, W.1. [6085]

MAINS EQUIPMENT.

- V**ORTEXION Leads Again.
 - V**ORTEXION Specified Single Spa Model, 350-100 m.a., 4v. 5a. C.T., 4v. 2.5a. C.T., 4v. 1a. C.T.; 25/-, less terminals, 23/-, less 5-year guarantee 21/-; power chassis, complete, £3/10; steel chassis only, 7/6; also normal model, shrouded, at 16/-, special shrouded choke 12/6.
 - V**ORTEXION.—Quality amplifier or super monodial, 425-0-425, 120 m.a., 4v. 6-8a. C.T., 4v. 3a. C.T., 4v. 1a., 4v. 1a., super shrouded, core size 2 1/2 in. x 1 1/2 in., 2 1/2% regulation primary engraved insulated terminals, weight 14lb., 28/-, carriage 2/-, normal shrouded, 22/-, open type, 20/-, post 1/3; speaker field replacement choke, 16/-; special output transformer, to "W. W." spec., 12/6.
 - V**ORTEXION 7-3oh, 120 m.a. Choke, 215 ohms, in die cast shrouding to match; 12/6.
 - I**MITATED, but unequalled. Good enough for a "Wireless World" specification is good enough for you.
 - V**ORTEXION Cost Little More than the Cheapest, but unequalled by the dearest.
 - V**ORTEXION Standards Despatched by Return.
 - V**ORTEXION A.C./34 used by author in construction of A.V.C. Three, as illustrated; 18/-.
- (This advertisement continued on next page.)

ENGINEERS—IMPORTANT OFFER

As the leading Institute of its kind in the World, we offer to prepare you at home for the **A.M.I.Mech.E., A.M.I.E.E., A.M.I.A.E.**, or similar qualification, on the distinct understanding that if you fail your Examination **your tuition fee will be returned to you in full.** Realise what a difference a few letters after your name will mean to you, and you will realise the value of our extraordinary offer to prepare you on **"NO PASS—NO FEE"** terms. Our record in the above Examinations is over **95% successes.** Whatever your age or experience you should apply immediately for a copy of our hand-book **"ENGINEERING OPPORTUNITIES,"** giving details of all leading Engineering Examinations, and over 100 Courses in all branches of **Civil, Mech., Elec., Motor, Radio and Aero. Engineering.**

This book is sent free and without obligation.

BRITISH INSTITUTE OF ENGINEERING TECHNOLOGY,
387, SHAKESPEARE HOUSE,
29/31, OXFORD STREET, LONDON.

Mains Equipment.—Contd.

(This advertisement continued from previous page.)

GUARANTEED 12 Months, and within 5% normal and 2½% super models, neat shrouding, with detachable feet, as used by Government Departments, etc., etc.; any model guaranteed 5 years at extra cost of 2/-.

VORTEXION—250-0-250 60 m.a. 4v. 1 to 2a., 4v. 2 to 4a., open type, 10/-; shrouded, 12/6; post 9d.
VORTEXION—Ferrocart III, 350-0-350, 60 m.a., 4v. 2.5 C.T., 4v. 3.5 C.T.; open type 13/6, shrouded 16/-; post 9d.
VORTEXION—Super model for H.T.8 or 9 or 10, 4v. 1 to 2, 4v. 2 to 4; open type 14/6; shrouded 16/6; post 1/-.

VORTEXION—350-0-350, 120 m.a., 4v. 2 to 5a., 4v. 2 to 4a., 4v. 2.5a.; open type, 14/6; shrouded, 16/6; super shrouded model, weight 11lb., 4 filaments to specification, 21/-; post 1/3.

VORTEXION—400 or 450 or 500v. 120 m.a., 4v. 2 to 5, 4v. 2 to 5, 4v. 2, 5a.; open type, 19/-; shrouded, 23/-.

VORTEXION—400 or 450 or 500, 150 m.a., 4v. 4a., 4v. 2.5, 4v. 2, 4v. 2, 4v. 2, core size 2¼×1¼in., a super job, 2% regulation, 35/-; shrouded, with terminals; less terminals, 30/-; open type, 26/-; post 1/3.

VORTEXION Auto Transformers to B.E.S.A. Specification, 100, 110, or 120v. to 200, 220, or 240 volts, 60 watts, 9/-; post 9d.; 120 watts, shrouded 12/6, open type 10/6, post 1/-; 200 watts, shrouded 16/6, post 1/-; 2,000 watts, £4/10.

VORTEXION 1,000-watt Transformers; £4/10, carriage free.
VORTEXION 30h. at 60 m.a. Chokes, 5/6; 40h. at 60 m.a., 8/6; 30h. at 150 m.a., 200 ohms, 10/6 open type, 12/6 shrouded.

VORTEXION Transformers Made to Your Specification; price according to wattage, 6v. filaments same price unless wattage grossly exceeded; special quotations by return.
VORTEXION (S. A. BROWN), 182, The Broadway, Wimbledon, S.W.19. Tel.: Liberty 2814. [5901]

MONOCHORD for Quality.
MONOCHORD Mains Transformers are Guaranteed for 3 years; all secondaries centre tapped.

MONOCHORD Single Span Model, 15/6 with terminals, 14/6 less terminals, post 1/-.
MONOCHORD 250-0-250v. 60 m.a., 4v. 1 to 2a., 4v. 2 to 4a., 10/-, post 9d.
MONOCHORD 350-0-350v. 60 m.a., 4v. 2.5a., 4v. 2 to 5a., 12/6, post 1/-.

MONOCHORD Chokes, 30h. at 60 m.a., 6/-, post 9d.
MONOCHORD Manufacture Mains Transformers for all "Wireless World" sets; send for list.

MONOCHORD RADIO, Ltd., Croft Avenue, Bromborough, Nr. Liverpool. Tel.: 122 Brom. [6080]
HEAYBERD Charger, 60v., 2a., tapped outputs; £5.-11, Calabria Rd., N.5. [6072]

SPECIAL Offer: 1,000 Tantalum strips, 5½in.×1.16in., suitable for trickle chargers; 1/3 each.
TANTALUM for A.C. Chargers, H.T. and L.T.—Blackwell's Metallurgical Works, Ltd., Garston, Liverpool. [5039]

SERADEX Products Specified for Universal Single Span Receiver, see displayed advert. on page iii.
SERADEX P.M. Speaker Supplies Now Available, equal to other makers' models at 63/-, 9 ratio transformer, for Class B, etc., 32/6.

SERADEX E.S. Speaker, 2,500 ohm field, etc., very sensitive; 25/-.
SERADEX Measuring Instruments, 2½in. scale bakelite cases, flush panel mounting, any reading to order, type F reads A.C. or D.C. accuracy 2%; back leads 6/- each; send for details of our full range.

TREVOR PEPPER, 575, Moseley Rd., Birmingham, 12. [6091]
SOUND SALES, Ltd., Transformers and Chokes specified "Wireless World"; lists free.—Tremlett Grove, Highgate, N.19. [0401]

HOYNE'S Transformers, fitted with tapped and screened primaries, filaments, all centre tapped, stout cast aluminium clamps and clearly marked terminal strips are fitted to all models; write for list.

HOYNE'S Components are Guaranteed for One Year; one type only manufactured, the best, as used by many well-known set manufacturers after testing all others.

HOYNE'S—"W.W." transformers, wound strictly to specification of author; "W.W." test reports, June 22nd: "The insulation is particularly good throughout... the transformer is satisfactory in all respects."

HOYNE'S—Push-pull quality amplifier transformer, 25/-, post 1/3; 7/30 henrys choke, 9/6, post 9d.; 20 henrys, 7/6, post 9d.

HOYNE'S—Single span, 15/-, post 1/-; choke, 10 henrys, 7/6, post 9d.
HOYNE'S—Everyman A.C. super transformer, 12/6, post 1/-; choke, 10 henrys, 7/6, post 9d.

HOYNE'S—A.V.C. Straight Four transformer, 18/-, post 1/3; choke, 26 henrys, 120 m.a., 140 ohms, 9/6, post 9d.
HOYNE'S—A.V.C. Three transformer, 12/6, post 1/-; choke, 30 henrys, 60 m.a., 7/6, post 9d.

HOYNE'S—250-0-250v. 60 m.a., 4v. 1 to 2a., 4v. 2 to 4a., 10/-, post 9d.; with extra 4v. 1 to 2a. winding, 12/6, post 1/-.

HOYNE'S—Ferrocart III, 350-0-350v. 60-70 m.a., 4v. 2 to 3a., 4v. 2 to 4a., 12/6, post 1/-; with extra 4v. 1 to 2a. winding, 13/6, post 1/-.

HOYNE'S—500-450-0-450-500v. 140 m.a., 4v. 2 to 4a., 4v. 4 to 6a., 4v. 2a., 4v. 2a., 27/6, post 1/3; weight 11lb.
HOYNE'S Transformers, built to specifications up to 1 K.V.A., keenest prices, best materials and workmanship; quotation by return.
M. J. HOYNE, ALL-POWER TRANSFORMER, Ltd., Offices and Works, 8a, Gladstone Rd., Wimbledon, S.W.19. Tel.: Liberty 3303. [6079]

The "Wireless World" again Confirms the Choice of the Majority of British Radio Manufacturers

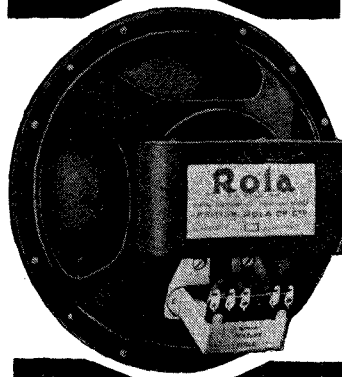

by
Solely Specifying
ROLA MODEL F7-PM29
(Price 60/-)
for the
UNIVERSAL
SINGLE SPAN RECEIVER

Because of their established reputation for unchallengeable tonal fidelity and unfailing reliability. Rola Speakers are used by the great majority of British Radio Manufacturers. Now, once again, the "Wireless World" has confirmed the wisdom of this choice by solely specifying Rola Model F7-PM29 for their outstanding "Universal Single Span" receiver. Compare this unit with any other you care to select and you will be the first to acknowledge its supremacy. Ask your dealer to-day.

EXTENSION SPEAKERS

There is a correct Rola Extension Speaker for practically all British Radio Receivers. Rola Speakers are used by nearly all British Radio Manufacturers. As it is highly desirable to have the speech coil impedance of the Extension Speaker similar to that of the Speaker in the receiver the necessity for using Rola Extension Speakers is manifest. Write to-day for the Rola Extension Speaker Broadsheet.

Write to-day for the Rola Folder.

THE BRITISH ROLA CO., LTD.
MINERVA ROAD, PARK ROYAL, N.W.10
 Phone: Willesden 4322-3-4-5-6.

ROLA
SPEAKERS
for better
Radio Reception

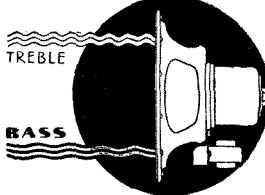

Over 4 Million in Use.

Mains Equipment.—Contd.

PARAMOUNT Mains Transformers are Equal to Any, yet unequalled in price; guaranteed for 12 months, and manufactured from the finest British materials; they are fitted with mat aluminium shrouds and frames, all filaments centre-tapped; finest quality insulating paper between each layer, and thoroughly tested before leaving our works.

PARAMOUNT 500-0-500v. or 450, or 400, 120 m.a., 4v. 5a., 4v. 4a., 4v. 2.5a., shrouded, screened primary, 21/-; open, 18/-; post 1/3.
PARAMOUNT Single Span 350-0-350v. 100 m.a., 4v. 5a., 4v. 2.5a., 4v. 1a., shrouded, screened primary, super regulation, 18/6, post 1/-.

PARAMOUNT 350-0-350v. 120 m.a., 4v. 2.5a., 4v. 2-4a., 4v. 2-5a., shrouded, screened primary, 16/-, post 1/-.
PARAMOUNT 250-0-250v. 60 m.a., 4v. 1-2a., 4v. 2-4a., 10/-; shrouded, 12/-, post 9d.

PARAMOUNT Chokes 30h. 60 m.a., 5/-, post 9d.; 20h. 120 m.a., 8/-.
PARAMOUNT Auto-transformers 100-120/200-250v. or vice versa, 60 watt 8/-, 120 watt 10/-, shrouded 12/-, post 9d.

PARAMOUNT Guaranteed Electrolytic Condensers, 4-0.4 mfd. 500v. peak, 3/6, post 3d.
PARAMOUNT for H.T.8, 9, or 10 4v. 1-2a., 4v. 2-4a., 15/6, shrouded, post 1/-.

PARAMOUNT—Write for details of our super inductance 5-valve receiver, with Rola moving coil speaker, Colvern Ferrocart coils, Polar condensers, and variable Mu valves; price £9; there is no greater value on the market, irrespective of price.

PARAMOUNT Mains Transformers, manufactured by Brook & Salter, 65, Hartfield Rd., Wimbledon, S.W.19 (one minute from Wimbledon Station). Tel.: Liberty 3226. [5998]

11/9—½ amp. charging unit kits; 1 amp., 12/9, including Westinghouse rectifier, Arden transformer and resistance, or Arden unit complete, in crackle finish case, incorporating Westinghouse rectifier and robust transformer, tested 2,000 volts; 2-6v. ½ amp., 13/11; 2-6v. 1 amp., 16/11; postage 9d.; 12 months' guarantee; 7 days' cash approval.—Arden Agency, Wollaton, Wellingborough. [5887]

CABINETS.

MANUFACTURERS' Clearance.
ULTRA "Panther," a modern cabinet, with contrasting figured walnut veneer panels, 20×17×11, 13/6; pedestal type, 35×22×12, 30/-, undrilled; photo sent on request.

SET and Speaker Cabinets; 5/- upwards.
RADIOGRAM Cabinets; 37/6 upwards.
SPEAKER Cabinets; 4/6 upwards.

SEND Particulars of Your Requirements (giving size of set, etc.), or call and make your choice from our stocks of over 100 different types; from 3/6 to £4/10.

REFER to Previous Adverts. for Detailed List of Bargains.
H. L. SMITH and Co., Ltd., 287-9, Edgware Rd., London, W.2. Tel.: Padd. 5891. [6052]

DYNAMOS, ETC.

ROTARY Converter, 110 D.C. to 250 volts A.C., 2 ampere, starter, transformer, 1 bedplate; £4.—Myer, 36, Oxford St., Liverpool. [6078]

LOUD-SPEAKERS.

27/6!!!—Brand new B.T.H.-R.K. speakers, 6v. field, suitable for P.A. work, etc.
£27/6!!!—B.T.H. speakers, as above, for 100-250v. A.C., complete with field rectifier.

MAGNAVOX D.C.152 (9in. cone), 22/6; Magnavox 154 (6¼in. cone), 16/3; all with hum-bucking coils, power or pentode transformers and 2,500 or 6,500-ohm fields; Magnavox P.M.254, 18/-.

ATTENTION to All Orders Within 24 Hours; carriage paid; cash with order or c.o.d.
WARD, 2nd Floor, 45, Farringdon St., London, E.C.4. Telephone: Holborn 9703. [5723]

VAUXHALL—Magnavox permanent magnets, universal, suitable for Class "B," power or pentode, 6in. cone 15/6; 7in. cone 17/6; 10in. cone 23/-; mains energised 2,500 or 6,500, 10in. cone 23/-; 7in. cone 15/3; brand new, with humbucking coils; state power or pentode transformer; Blue Spot P.M.29M, suitable for Class B, pentode, super power and power, 21/-; unused manufacturers' stock; immediate delivery, carriage paid, cash with order or c.o.d.—Vauxhall Utilities, 163a, Strand, W.C.2. Temple Bar 9338. [6008]

VALVES.

ALL Types of Brand New American Valves in Stock; first-class makes, guaranteed.
247, 235, 551, 89, 18, 19, 46, 59, 6A7, 15, 42, 41, 38, 39, 73, 75, 57, 58, 224, 44, 36, 235, 33, 43, 12/-; 2525 14/8; U.X.171A, U.X.199, U.X.280, U.X.245, U.X.226, U.Y.227, 7/6; U.X.250, U.X.210, U.Z.231, 17/6; U.X.867 photocells, 25/-; various transmitting valves in stock; post paid; cash with order or c.o.d.

WARD, 2nd Floor, 45, Farringdon St., London, E.C.4. 'Phone: Holborn 9703 [5722]

FREE—List of American and non-rng valves.—Epton, 93, New Rd., Chingford, E.4. [6086]

PREMIER SUPPLY STORES Announce the Purchase of the Complete Stock of a World Famous Continental valve manufacturer; all the following standard main types fully guaranteed, 4/6 each; H., H.L., L. power, medium, high, low mag., and variable mu screen grids, one, three and four Watt A.C. output, directly heated pentodes, 250v. 60 m.a. full wave rectifiers, d.c. types, 20v. 18 amp., filaments, screen grid H., H.L. power.

THE Following Types, 5/6 each; 350v. 120 m.a., full wave rectifier, 500 v. 120 m.a. full wave rectifier, 2½ Watt indirectly heated pentode.
THE Following American Types, 4/6; 250, 112, 171, 210, 245, 226, 47, 46, 24, 35, 51, 57, 58, 55.

PREMIER SUPPLY STORES, 20 and 22, High St., Clapham, S.W.4. [6011]

HARTLEY TURNER RADIO LTD.

beg to announce that the
**HARTLEY TURNER LOUD
SPEAKER, KIT SETS and
GRAMOPHONE AMPLIFIERS**
will not be reduced in price
during 1934

Our policy is to offer only that apparatus which is good as can be made; this implies the individual attention of skilled craftsmen and the large amount of hand-work in Hartley Turner products results in cost of manufacture being high. A good workman has to be paid well, otherwise imperfect goods are liable, sometimes inadvertently, to be sold.

Additions to our products will be revealed at Olympia and we look forward to meeting old customers and also those enthusiasts to whom "REALISTIC REPRODUCTION" is of vital interest, but who have not yet become possessors of our apparatus.

HARTLEY TURNER RADIO LTD.,
Thornbury Rd., Isleworth, Mdx.
TELEPHONE: HOUNSLOW 1854.

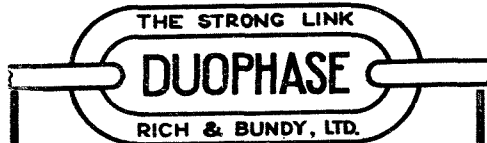

The Duophase system of operating two valves in phase opposition utilises a COMBINED OUTPUT and GRID COUPLING TRANSFORMER.

This transformer displaces the normal output transformer fitted to the moving coil speaker. DUOPHASE TRANSFORMERS can be supplied for any combination of triode output valves and speakers.

Types are available to suit
P.X.25, P.X.4, P.P.5/400,
P.P.3/250, D.O.24, D.O.26,
etc. to match speakers
"R.K.", "Rola", "Magnavox."
It is important that details
of valves and speech coil
impedance should be given
when ordering.

**MODEL D.P.4
DUOPHASE
TRANSFORMER**

Price
30/-

RICH & BUNDY LTD.
Transformer Manufacturers,
NEW ROAD, PONDERS END, MIDDX.
Telephone: Enfield 9777.

**HARTLEY TURNER SPEAKERS
AND AMPLIFIERS SUPPLIED ON
EASY TERMS.**

We specialise in the supply of this superb equipment on convenient terms. Please write for full particulars and quotation.

All other high-grade radio Apparatus supplied on the best terms.

**THE LONDON RADIO SUPPLY
COMPANY,**

11, OAT LANE, NOBLE STREET, LONDON, E.C.2.
Phone: National 1977. (Est. 1925).

Valves.—Contd.

SURPLUS Valves.—All brand new; battery types, 2-volt, H.F.2, L.F.2, L.P.2, 1/9; super power, P.P.2, 2/6; screens and pentodes, 3/9; A.C. mains, 4-volt 1 amp., general purpose, 3/3; power, 4/-; screens and pentodes, 4/6; full wave rectifiers, 3/6; postage paid, cash with order, or c.o.d. over 10/-.—Clarion Radio Valve Co., 885, Tyburn Rd., Edlington, Birmingham. [6075]

COMPONENTS, ETC., FOR SALE.

R.
RYALL'S RADIO, 33, Chancery Lane, London, W.C.2 (nearest Tube, Chancery Lane; bus 67 passes door, or tram to Savoy St.). Holborn 3529. Open Saturday afternoon. Close 7 p.m., Saturday 5 p.m., Thursday closed 1 o'clock.

UNIVERSAL Avometer with Avodaptor, high voltage leads, etc., latest type, new within the last few weeks, unsoiled, cost £14, accept £9 lowest; set Ferranti twin meters, 1/10th to 250v., 1,000 ohm per volt, 10 m.a. to 25 amps., listed £7/10, accept £4; Ferranti portable 3 range voltmeter 0-250v., 1,000 ohm per volt, list 72/-, accept 45/-.

RADIOPHONE Radiopacks, B.P. and H.F. 30/-; R.F. superhet 117.5 K.C. 30/-; 110 K.C. ditto; B.P. superhet 110 K.C. 30/-; all postage 1/3; Varley P.P. input transformer, new, 10/6; Clydon dual thumb drive, 0.005, new, 7/6.

PAIR R.I. Class B Transformer and Choke, second hand, 14/-; Lewcos frame aerial 7/6; Rich and Bundy chokes, E154 2EH, at 50 m.a. 90 ohms, 12/5; Varley 5 amp. filament transformers, input 200/250v., 8/6.

GARRARD D/S Gramophone Motor, complete with unit plate, perfect, plays 3 12in. records, cost £3, 25/-; Varley EP24 transformer 500/500v., 3-4v. 5amp. windings, new, 31/6; pair Varley P.P. transformers, DP6, DP7, new, 20/-.

SET Peto Scott Single Span Coils, complete, 20/-; S.H.M.V. pick-up similar Marconi K17, 25/-; B.T.H. senior, new 22/-; Ferranti AF7c, 21/6; B2 choke, 10/6; Bulgin transcoupler, 7/6; Varley 20H 120 m.a. chokes, 10/6; Lotus Bud DC2 set, new, 90/-.

WEARITE A.V.C. Unit, new, 6/-; Varley A.V.C. unit, 7/6; pair T.C.C. 0.1 mica condensers, 800 v.w., 7/6; set Telsen S330 coils, 14/-, new; Radiophone 3-gang Superhet condenser with cover, 10/6; type 693, 14/6.

R. [6081]

24.

MILDMAY RADIO EXCHANGE Offers the Following, sound and perfect; cash with order or c.o.d.

19³⁴ Ekco Model 74 A.C. Mains Superhet Receiver, complete with valves, suitable for mains of 200-250v. A.C., boxed; £8/10.

EKCO Mains Units.

TYPE K12, suitable for sets up to 3 valves, output 150v. 12 milliamps, incorporating trickle charger for 2, 4, or 6v. accumulators, 200-250v. mains; 35/- each.

TYPE A.C.25, output 150v. 25 milliamps, having 4 tapings, 2 variable, listed at £3/17/6; our net price, 33/6.

TYPE K25, output 150v. 25 milliamps having 4 tapings, 2 variable, with charger for 2, 4 or 6v. accumulator, listed at £5/7/6; our price 39/- each.

SPECIAL Offer Ferranti Inductor Dynamic Speakers, equal and in fact better than cheap moving coil speakers; 20/- each.

19³⁴ Ferranti "Lancastria" Superhet Receiver, complete with valves boxed; £8/10, listed at £14/3/6.

19³⁴ Cossor Model 347 4-valve A.C. Mains Receiver, with moving coil speaker and complete with valves; £7.

19³⁴ Cossor Model 342 3-valve Battery Receiver, complete with valves and moving coil speaker, listed £7/2/6; our net price £4/2/6.

MARCONI Model 260 4-valve Battery Receiver, complete with valves and moving coil speaker; £5.

MARCONI Model 252 3-valve Battery Receiver, complete with valves, in walnut cabinet, screen grid, pentode output, limited number only; £5/15 each.

MARCONI Model 248 2-valve Battery Receiver, with valves and speaker, in walnut cabinet; 25/6 each, limited number only.

TELSEN Super Selective Six Receiver, 6-valve superhet battery operated, including valves; £5.

SPECIAL Offer: Lotus All-power Units, giving H.T., S.L.T., and grid bias, complete and brand new, for mains of 200-250v.; 37/6 each.

VARLEY A.V.C. Units, 5/- each; Wearite ditto, 5/- each; Multitone Class "B" adaptor, less valve, 22/6, valve 5/-; Varley Nicore I transformer, 9/6; Hypercore choke, 10/-; Audrad choke, 4/6; Westinghouse H.P.1, 17/6; Ferranti transformer for same, 6/6; Varley ditto, 5/-.

FERRUCART G1, G2, G3, 25/-; F1, F2, F3, 25/-; G10, G11, G12, G13, 32/6; Colvern K21, K22, K23 superhet coils, 12/- set; Colverdynes, 7/- each; Radiopaks band pass superhet, 30/- each.

THE Above Post or Carriage Paid.

PHONE: Clissold 5001.

OPEN All Day Thursday, closed on Saturdays.

24, Mildmay Grove, London, N.1. [6094]

MARCONIPHONE Pick-up No. 17, 17/6; R.F. superhet, Radiopak, 25/-; Magnavox "Magna" D.C. 142 (universal output), 32/6; H.T.8, 8/-; two A.F.5's, 12/6 each; Harlie pick-up, 10/-; all perfect.—8, Hunslet St., Nelson. [6095]

The
ELEMENTARY PRINCIPLES
of
WIRELESS TELEGRAPHY
and
TELEPHONY

by
R. D. BANGAY

Third Edition
Revised by O. F. Brown, B.Sc.
(1930)

THE standard book of instruction for wireless beginners and students. This revised edition brings the whole subject into line with modern developments in wireless. The style is clear and simple and attention is given to the theoretical elements of electricity and magnetism: to the dynamo: and to the properties of waves. A leaflet which gives full particulars of the volume, including a synopsis of the chapters, will be sent on request.

PRICE

7/6 net By post 8/-

From all leading Booksellers
or direct from the Publishers

ILIFFE & SONS LTD.
Dorset House
STAMFORD STREET, LONDON, S.E.1
W.W.97

**DICTIONARY
of WIRELESS
TECHNICAL TERMS**

Compiled by
S. O. PEARSON, B.Sc., A.M.I.E.E.
and issued in conjunction with
"THE WIRELESS WORLD"

Second Edition. Completely revised and
brought up to date

This handy volume is very much more than a Dictionary. It not only takes the technical terms of wireless and explains their meaning, but in doing so it concentrates into a small space a large amount of information on wireless subjects. It has become, in fact, a compendium of current wireless knowledge, and an invaluable handbook for all who are interested in wireless transmission and reception. Diagrams and illustrations are freely interspersed throughout the book to amplify the explanations of the text.

272 pp., bound in cloth boards
Size 5 by 3 inches

Price 2/- net. By post 2/2

From all leading booksellers or direct from the
Publishers

ILIFFE & SONS LTD.
Dorset House, Stamford Street, London, S.E.1
W.W.43

Components, Etc., for Sale.—Contd.

PREMIER.
PREMIER SUPPLY STORES Offer the Following Set Manufacturers' Surplus New Goods at a Fraction of the Original Cost; all goods guaranteed perfect, carriage paid over 5/-, under 5/- carriage forward, I.F.S. and abroad, carriage extra.
SPECIAL Offer of P.M. and Energised M.C. Speakers, from well-known gramophone manufacturer.
TYPE 10971G, 9in. diameter, 115 ohm field, 120-200 m.a., with power output transformer, handle 4 watts; 17/6.
TYPE 10971C, 9in. diameter, 2,000 ohm field, 40-70 m.a., Pentode transformer, handles 4 watts; 17/6.
TYPE 10955F, 9in. diameter, 11,650 ohm field, 20-30 m.a., auditorium type power transformer, handles 10 watts; 30/-.
TYPE 10955H, 9in. diameter, 115 ohm field, 350-400 m.a., auditorium type Pentode transformer, handles 10 watts; 30/-.
TYPE 4480B, 9in. diameter, permanent magnet, handles 4 watts, 7 ohms speech coil, 13/6; Multi ratio transformer, 4/6 extra.
ELIMINATOR Kits, including transformer, choke, Westinghouse metal rectifier, T.C.C. condensers, resistances and diagram, 120v., 20 m.a., 20/-; trickle charger, 3/- extra; 150v. 30 milliamps, with 4v. 2-4 amps C.T. L.T., 25/-; trickle charger 6/6 extra; 250v., 60 milliamps with 4v. 3-5 amps C.T. L.T., 30/-; 300v. 60 m.a. with 4v. 3-5 amps, 37/6; 200v. 100 m.a., 39/6.
PREMIER Chokes, 40 milliamps, 25 hys., 4/-; 65 milliamps, 30 hys., 5/6; 150 milliamps, 30 hys., 10/6; 60 milliamps, 80 hys., 2,500 ohms, 5/6; 25 milliamps, 20 hys., 2/9.
ALL Premier Guaranteed Mains Transformers have Engraved Terminal Strips, with terminal connections, input 200-250v., 40-100 cycles, all windings paper interleaved.
PREMIER H.T.7 Transformer, output 135v. 80 m.a. for voltage doubling, 8/6; 4v. 3-4a., C.T. L.T., 2/- extra; with Westinghouse rectifier giving 200v. 30 m.a., 17/6.
PREMIER H.T.8 and 9 Transformers, 250v., 60 m.a., and 300v. 60 m.a. rectified, with 4v. 3-5a. and 4v. 1-2a. C.T. L.T. and screened primary, 10/-; with Westinghouse rectifier, 18/6.
PREMIER H.T.10 Transformer, 200v. 100 m.a., rectified, with 4v. 3-5a., and 4v. 1-2a. C.T. L.T. and screened primary, 10/-; with Westinghouse rectifier, 18/6.
PREMIER Mains Transformers, output 250-0.250v. 60 m.a., 4v. 3-5a., 4v. 2-3a., 4v. 1-2a. (all C.T.), with screened primary; 10/-.
PREMIER Mains Transformers, output 350-0.350v. 90 m.a., 4v. 3-5a., 4v. 2-3a., 4v. 1-2a. (all C.T.), with screened primary; 10/-.
PREMIER Auto Transformers, 100-110/200-250v. or vice versa, 100-watt; 10/-.
L.T. Transformers, 4v. 3a. C.T., 6v. 2a. C.T., 9v. 1a., 12v. 1a., 5/6 each; 4v. 3-5a., 22v. 1a., 8/6 each; 10v. 3a., 14v. 4a., 10/- each.
SPECIAL Offer of Mains Transformers, manufactured by Phillips, input 100-120v. or 200-250v., output 180-0.180 volts 40 m.a., 4v. 1 amp., 4v. 3 amps., 4/6; 200-0.200v., 4v. 1a., 4v. 3a., 4/6.
SPECIAL Offer Manufacturers' Type Transformers, 350-0.350 100 m.a., 4v. 1a., 4v. 2a., 4v. 3-5a., 10/-; input 200-250 A.C.; 350-0.350 120 m.a., 4v. 2-3a., 4v. 2-4a., 100-120v., input only, 5/-.
WESTERN ELECTRIC Mains Transformers, 300-0.300v. 65 m.a., 4v. 1-2a., 4v. 2-3a., 8/6; 500-0.500v. 150 m.a., 4v. 3-5a., 4v. 2-3a., 4v. 1a., C.T., 4v. 1a. C.T., 19/6; 1,000-0.1,000v. 250 m.a., 4v. 3a. C.T., 4v. 3a. C.T., 49/6; 2,000-0.2,000 150 milliamps, 49/6.
PREMIER L.T. Charger Kits, consisting of Premier transformer and Westinghouse rectifier, input 200-250v. A.C., output 8v. 1-2 amp., 14/6; 8v. 1 amp., 17/6; 15v. 1 amp., 19/-; 6v. 2 amp., 27/6; 30v. 1 amp., 37/6; 2v. 1/2 amp., 11/-.
COLLARO Gramo. Unit, consisting of A.C. motor, 200-250v. high quality pick-up and volume control, 49/-; without volume control, 46/-.
B.T.H. Trussed Induction Type (A.C. only) Electric Gramophone Motors, 100-250v.; 30/- complete.
B.T.H. Gramophone Motors, 100-250 volts A.C. or D.C., specially recommended for D.C., complete; 30/-.
EDISON Bell Double Spring Gramophone Motors, complete with turn-table and all fittings, a really sound job; 15/-.
SPECIAL Offer of Wire Wound Resistances, 4 watts, any value up to 50,000 ohms, 1/-; 8 watts, any value up to 15,000 ohms, 1/6; 15 watts, any value up to 50,000 ohms, 2/-; 25 watts, any value up to 50,000 ohms, 2/6.
WIRE Wound Potentiometers, 15,000 ohms, 1/6; 50,000 ohms, 2/-; 500,000 ohms, 3/-; 1,000 ohm wire wound semi variable resistances, carry 150 m.a., 2/-.
CENTRALAB Potentiometers, 50,000, 250,000, 1-2meg. any value, 2/-; 200 ohms, wire wound, 1/-.
POLAR Star, manufacturers' model, 3-gang condensers, fully screened, 7/6; with trimmers.
ORMOND and Polar All-brass 0.0005 Condensers, with knob dial, 2/-; with slow motion drive, 3/-.
AMERICAN Triple Gang 0.0005 Condensers, with trimmers, 4/11; Utility Bakelite 2-gang 0.0005 screened with uniknob trimmer, 3/6; Polar Bakelite condensers, complete with knob, 0.00015, 0.00035, 0.0003, 0.0005, 1/-.
ORMOND Condensers, 0.0005 2-gang semi-shielded, 2/6; brass vanes, with trimmers, 3/6.
MAGNAVox D.C.152, 2,500 ohms, 17/6; D.C.154, 2,500 ohms, 12/6; D.C.152 Magna, 2,500 ohms, 37/6, all complete with humbucking coils; please state whether power or Pentode required; A.C. conversion kit for above types, 10/-; Magnavox P.M. 7in. cone, 18/6.
AMPLION Loud-Speaker Units, 1/6; complete with 12in. cone and chassis, 3/11.
RELIABLE Canned Coils with Circuit, accurately matched, dual-range, 3/- per coil; ditto, iron cored, 3/6.
(This advertisement continued in third column.)

YOU HAD TROUBLE WITH VOLUME CONTROL LAST YEAR . . .

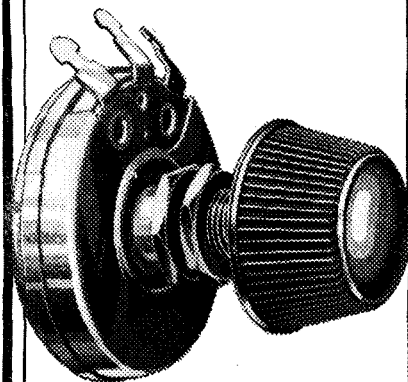

TYPE P. PRICE 3/9. With knob. Also Type P.S. Price 4/6. With knob and switch.

The Ferranti Potentiometers are silky in action and constant in value. Whilst they are not usually required to carry appreciable current, they will dissipate 0.25 watt continuously. They have a slight negative temperature co-efficient.

A number of years of study and experiment were necessary in evolving this really satisfactory Potentiometer, one which Ferranti Ltd. believe to be the best available for general Volume Control purposes.

To Manufacturers:—
 Let Ferranti quote you competitive prices for trouble-free Potentiometers and save trouble in the future.

Send for list Wb.520 which gives full details

FERRANTI POTENTIOMETERS

FERRANTI LTD.
 HOLLINWOOD, LANCASHIRE.

Components, Etc., for Sale.—Contd.

(This advertisement continued from first column.)

RELIABLE Intervalve Transformers, 2/-; Cydon capacitors (double trimmers), 1/-; multi ratio output transformers, 4/6.
WESTERN ELECTRIC Condensers, 250v. working, 1 mf., 6d.; 2 mf., 1/-; 4 mf., 2/-; 400v. working, 1 mf., 1/-; 2 mf., 1/6.
T.C.C. Electrolytic Condensers, 550v. working, 650v. peak, 8 mf., 4/-; 4 mf. or 8 mf., 440v. working, 3/-; 15 mf. 50v. working, 1/-; 25v. working, 25 mf., 1/3; 6 mf. 50v. working and 2 mf. 100v. working, 6d.; 16+4 mf. 250v. working, 6/-.
T.C.C. Condensers, 250v. working, 2 mf., 1/9; 2 mf. 1,500v. working, 6/-; 4 mf. 1,500v. working, 10/-.
HM.V. Condensers, 400v. working, 4x4x1x1x1x1x0.1 x0.1x0.1x0.1, 6/-; 4x2x1x1x1x0.5, 4/6.
DUBILIER Condensers, 2 mfd., 1,200v. working, 4/-; 8 mfd. dry electrolytic 450v. working, 3/-.
VARLEY Constant Square Peak Coils, band pass type BP.7, brand new in maker's carton with instructions and diagram, 2/6.
VARLEY H.F. Intervalve Coils BP.8, band pass, complete with instructions in original cartons, 2/6.
SCREENED H.F. Chokes by One of the Largest Manufacturers in the Country; 1/9.
PREMIER British-made Meters, moving iron, flush mounting, accurate, 0-10, 0-15, 0-100, 0-250 m.a., 0-1, 0-5 amps.; all at 6/-.
ALARGE Selection of Pedestal Table and Radiogram cabinets, by best manufacturers, at a fraction of original cost, for callers.
THE Following Lines 6d. each, or 5/- per dozen.—Chassis valve holders, 5-, 6-, or 7-pin, screened screen grid leads; any value 1-watt wire end resistances, wire end condensers, 0.0001 to 0.1 trimming condensers, Bulgin 3-amp. mains switches.
PLEASE Send for Fully Illustrated Catalogue.
PREMIER SUPPLY STORES, 20, High St., Clapham, S.W.4. Telephone: Macaulay 2188. Nearest Station, Clapham North Underground. 16010
GILBERT INDUSTRIES, Ltd.
PARCEL Containing 6 gross All Brass Screws, in useful B.A. wireless sizes such as 4 B.A. x 1/4in., 6 B.A. x 3/4in., etc., etc.; they include round, cheese and countersunk heads, and with every parcel we include 1 gross assorted nuts free, 5/-; post paid.
GILBERT INDUSTRIES, Ltd., 519, London Rd., West-cliff-on-Sea, Essex. [5997]
MAINS RADIO DEVELOPMENT COMPANY Guarantee the following surplus.
READY Radio Boxed Spaghetti Resistors, 10,000, 15,000, 20,000, 25,000 ohms, and Mikado, .0005, .002 mfd. condensers, any dozen, 9d.
FERRANTI AF5, 9/6; Brown's 5-1, or Ready Radio 3-1 bakelite L.F. transformers brand new, 2/9.
BULGIN On-off Toggle 6d.; Sator., .0001, .0003 mfd. tubular condensers, 1/- per 6; Wego .02 mfd. tubulars, 4d.
UTILITY Reaction Condensers, .0005, .0005, new, 8d.; chassis 4-5 pin valve holders, 1/- per 6.
MAINS RADIO DEVELOPMENT COMPANY, 4-6, Muswell Hill Road, London, N.6. Tudor 4046. [6074]
UTILITY SALES Co. Offer the Following Surplus Goods, all new and boxed and fully guaranteed:—
CELESTION P.M.M.W. Speaker; list 45/-, 17/6.
EKCO 1/2 amp. 2-4-6-volt L.T. Charger, list £27/6, 17/6; also A.C. 25, 31/6; K.25, 38/8.
MAINS Transformers by Standard Cable Co., primary 200-240, secondary 300-0.300, 60 m.a., 4v. 3a. ct., 4v. 2a., very strongly recommended; 6/6.
ALL Our Goods are Delivered Within 24 Hours—carriage paid.
UTILITY SALES Co., 27a, Sale St., Paddington, London, W.2. [6099]
RAUDIO CLEARANCE Offers the Following Manufacturers' Surplus of Components at Bargain Prices.
MAINS Transformers, input 200-250v., output 320-0.320 at 60 m.a., 4v. at 3 1/2 amps C.T., 4v. at 2 1/2 amps C.T.; 8/6 each.
MAINS Transformers, input 200-250v., output 320-0.320 at 70 m.a., 4v. at 6 1/2 amps C.T., 4v. at 2 1/2 amps C.T., shrouded, terminal type; 10/6 each.
MAINS Transformers, input 200-250v., output 320-0.320 at 70 m.a., 4v. at 4 1/2 amps C.T., 4v. at 2 1/2 amps C.T., shrouded, terminal type; 9/6 each.
COILS.—Set of Band Pass Coils for S.G.3 matched manufacturers' type; 4/6 per set.
COILS.—Set of coils for 5-valve superhet., matched set of 3, manufacturers' type; 4/6 per set.
INTERMEDIATE Frequency Transformers, 110 kc/s; 3/- each.
SWITCHES (Platform type) Suitable for Band Pass, medium, long and gram.; 2/- each.
VOLUME Controls by G.E.C., 8,000 ohms, log wound with switch; 2/6 each.
8 mfd. Electrolytics by Dubilier, 500 volt peak; 2/6 each.
2 mfd. Condensers, by Wego, type G.B.; 1/6 each.
REACTION Condensers, 0.0003, Polar; 1/- each.
3-GANG Condensers, Plessey, with 110 kc/s section, complete with drive, scale and knob for superhets; 10/6 each.
PARALLEL Féd Transformers, by well-known manufacturer, ratio 6-1; 3/- each.
ALL Lines Post Free in U.K.
RAUDIO CLEARANCE, 94, High Holborn, W.C.1. Telephone: Holborn 4631. [5925]
PEARS and PEARL Bargain List A Free.—190, Bishopsgate, London, E.C.2. [70421]



12 WATMEL HYWATT RESISTANCES

are specified for the
'UNIVERSAL SINGLE-SPAN RECEIVER'

Also the Watmel P.25 Mains Resistance
Need we say more? **PRICE 7/6**

This is the most advanced resistance yet put on the market and is already extensively used by leading set makers.

Made in 1—50,000 ohms. Price 1/-

For full details please write to:—

WATMEL WIRELESS CO. LTD.,
Imperial Works, High Street, Edgware, London. 'Phone: Edgware 0323.



C.R.C. 104

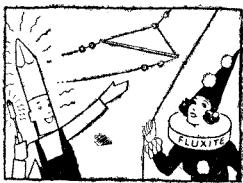

"We're Fluxite and Solder—the reliable pair;
Famous for Soldering—known everywhere!
To make good reception a foregone conclusion;
Use Fluxite and Solder—no fear of 'confusion'!"

See that Fluxite and Solder are always by you—in the house—garage—workshop—anywhere where simple, speedy soldering is needed.

ALL MECHANICS WILL HAVE FLUXITE IT SIMPLIFIES ALL SOLDERING

All Ironmongers sell Fluxite in tins: 4d., 8d., 1s. 4d., and 2s. 8d. Ask to see the **FLUXITE POCKET SOLDERING SET**—complete with full instructions—7s. 6d. Ask also for our leaflet on **HARDENING STEEL** with Fluxite.

FLUXITE LTD. (Dept. W.W.),
Dragon Works, Bermondsey Street, S.E.1

FOR ALL REPAIRS!



Components, Etc., for Sale.—Contd.

SOUTHERN RADIO'S Bargains.—Set manufacturer's guaranteed surplus.

VARIABLE Condensers.—Lotus 3-gang 0.0005, 12/6; Lotus 2-gang, 0.0005, 8/6; Lotus Dyblock single, 0.0005, 4/9 (list 9/6); all these condensers are complete with dials, escutcheons, knobs, fully screened with trimmers, and boxed; Hydra block condensers, 16 mfd. (2+2+8+2+1+1), 1,000v. D.C., 7/- each; Dubilier 4 mfd. (2+1+1), 1,000v. D.C., 2/9; 4.5 mfd. (2.25+2.25), 1,000v. for mains noise suppression, 3/-; fixed 4 mfd., 2/3; 2 mfd., 1/6; 1 mfd., 1/-; Utility Midget 2-gang variable condensers, 0.0005, with concentric trimmers, 3/5; T.C.C. 0.1+0.1, 1/3 each.

SPEAKERS.—Blue Spot permanent magnet, with universal transformer for power, super power, pentode and Class B; 23/- (list 39/6).

G.E.C. Stork Speaker, in cabinet; 19/6 (list £3/15).

BLUE Spot Genuine 100U Inductor Speaker on Chassis; 13/6 (list 39/6).

S.T.400 Kits, all specified proprietary components; £2/19/6 (list £4/17/6).

EKCO A.C. Eliminators, each new and boxed, in original sealed cartons, type K25, with trickle charger, 25 millamps, 39/6 (list £5/7/6); type A.C.25, 33/6 (list £3/17/6); type K.12, with trickle charger, 37/- (list £3/17/6); Ekco trickle chargers, type T.C.L., for 2-4 and 6-volt accumulators, 20/- (list 42/-).

IGRANIC Superhet. Coils, set of 4 (1 Osc., 2 I.F. with pig tails, 1 I.F. plain); 12/6 (list 50/-).

IGRANIC Band Pass 3 Coils Unit, iron-cored, screened on base, with switch; 14/- (list 33/-).

LISSEN Superhet. 3 Coils Unit, screened, ganged on base with wave change and filament switches; type L.N.5181, for battery or mains; 12/6 (list 30/-).

VARLEY Constant Square Peak Coils, complete with all accessories, new, boxed, B.P.5; 2/4.

VARLEY H.F. Inter-valve Coils B.P.6, 2/3.

5-VALVE Class B Superhet. Chassis, made by Plessy, wired ready for use, with 5 Mullard valves, new, in sealed cartons; £3/17/6 complete (list £12/12); valves alone are priced £3.

FRAME Aerials.—Lewcos dual wave superhet., 9/- each (list 27/6).

PICK-UPS.—Marconi No. 19 (1934), 22/6 each (list 32/6); Celestion latest improved type W8 (1934), 16/9 (list 35/-); all new and boxed.

READY Radio Instamat Transformers, for matching any valve to speaker; Junior model, ratios 1:2, 1:1, 1:1, 1:2, 1:1, 3:1, 7:6 (list 27/6); Senior model, ratios 10:1, 12:1, 14:1, 16:1, 20:1, 25:1, 12/6 (list 37/6).

RECEIVERS.—3-valve screen-grid Elector Super, complete with valves, Exide batteries and accumulator, Celestion moving coil speaker, contained in magnificent walnut cabinet; £3/10 (list £10).

OSRAM Thirty-Three Music Magnet, complete with G.E.C. speaker, two Osram screen-grid and Osram power valves in moulded bakelite-walnut cabinet; £3/12/6 (list £9/9); in original sealed cases.

READY Radio Meteor Screen-grid 3-valve Kits, all specified components new in sealed cartons; 25/-, less valves; with 3 Mullard valves 42/6 (list £5/7/6).

"A" Kit as Above, complete with magnificent walnut cabinet and Celestion perm. mag. speaker; less valves, £3/5; with 3 Mullard valves, £4/2/6 (list £8/17/6).

COSSOR "Melody Maker" 3-valve A.C. Kit, model "356," including cabinet, 4 Cossor valves (including rectifier), power unit, and all components; £4/17/6 (list £9/15); new in sealed cartons.

MAINS Transformers.—Full list of mains transformers and chokes sent free.

MISCELLANEOUS.—Rotorohm volume controls, all values, 5/- each, with switch, 3/3 (list 10/6); Hellesen's 8 mfd. electrolytic condensers, 2/9 each; Westinghouse metal rectifiers, H.T. 6, 7, 8, 9/3 each; Ferranti chokes, 20 henry 60 m.a., 6/9 each; Ready Radio I.F. transformers, 5-1, 3-1, 3/3 (list 8/6); Lewcos superhet. 8-way bases, complete with valve holders, grid leak, fixed condenser type "48," 2/- each; Lissen base turntables, 1/6 (list 5/-); Lissen H.F. chokes, 1/6 (list 5/-); Lewcos coils, B.P.F./R., 4/-; T.B.F./C., 3/3; O.S.C./126 (Extensor), 3/3; T.O.S./R., 3/3.

ALL Goods Guaranteed and Sent Carriage Paid; hundreds of other bargains in stock.

BRANCHES at 271-275, High Rd., Willesden Green, N.W.10, and at 46, Lisle St., W.C.2. Please send all post orders to 323, Euston Rd., N.W.1.

SOUTHERN RADIO, 323, Euston Rd., London, N.W.1 (near Warren St. Tube). 'Phone: Museum 6324. [6084]

THE Following Unused Set Manufacturers' Surplus, all goods guaranteed perfect, immediate delivery.

"FERROCART" Coils, G1, G2, G3, with switch, 27/6; G11, G12, G13, G14, with switch, 33/6; Colverdynes, 7/6; brand new Radiopaks, all types, 35/-.

DUBILIER Resistors, 1 watt type, 7d.; 2 watt type, 1/3; Marconi K19 pick-ups, 22/6.

WESTINGHOUSE Rectifiers, H.T.8, 9/6; H.T.9, H.T.10, L.T.4, L.T.5, 10/9; transformers (Regentone) for H.T.8 or H.T.9, with 4 amp. L.T., 7/6.

TRANSFORMERS, 350-0-350v., 60 m.a., 4v. 4a., 4v. 2a., 12/6; A.C. and D.C. eliminators, first-class make, tappings, S.G., detector, power (150v. 25 m.a.), A.C. type with Westinghouse rectifier, 25/-; D.C. type, 12/-.

DUBILIER or T.C.C. Electrolytic Condensers, 8 mfd. or 4 mfd., 50v., 50v. 50 mfd., 3/6; B.T.H. pick-up tone arms 3/-.

CARRIAGE Paid, cash with order or c.o.d.; send for list.

WARD, 2nd Floor, 45, Farringdon St., London, E.C.4. Telephone: Holborn 9703. [5724]

FERROCART 2 H.F. 4-gang., 26/6; Marconi pickup, 19/6; Novotone Senior, 25/-; all perfect.—53, Toston Drive, Wellaton Park, Nottingham. [6090]

H. A. WIRELESS for Everything Radio; summer sale now on; send your lists for London's keenest quotation; everything brand new and guaranteed.

H. A. WIRELESS (SHOREDITCH), Dept. W.W., 9 & 13, Hackney Rd., Shoreditch, E.2. BISHopsgate 8169. [6088]

RADIO DATA CHARTS

A SERIES OF ABACS

providing most of the essential
Data required in Receiver Design

By
R. T. BEATTY, M.A., B.E., D.Sc.

Reprinted from
"The Wireless World"
(1930)

"Radio Data Charts" provide designers of wireless apparatus with a ready and convenient means of solving problems without having recourse to complicated formulæ and mathematics.

By the use of the charts it is possible to tackle all the more familiar problems in radio receiver design, such as, for example, finding the relationship between inductance capacity and frequency, and working out the design of high frequency transformers. All keen amateurs will appreciate this helpful book.

(39 CHARTS and more than
50 Diagrams)

Price 4/6 net
By post 4/10

Published from the Offices of
"THE WIRELESS WORLD"

From all leading booksellers or direct
from the Publishers

ILIFFE & SONS LTD.
Dorset House,
Stamford St., London, S.E.1

W.W.93

Components, Etc., for Sale.—Contd.

VAUXHALL—Radiophone Radiopaks, only few left, band-pass or R.F. superhet, 117 kc/s or 110 kc/s, with Lucerne wavelength, station named scales, medium and long, complete with volume control; 32/6.
VAUXHALL Radiophone I.F. Transformers, with terminals, 6/-; Radiophone volume controls, with switch, all values, 3/6.
VAUXHALL—Benjamin Class B driver transformers, ratios 1-1 and 1½-1, 6/6; Radiophone Class B, ratio 1-1, 10/-.
VAUXHALL—Radiophone gramophone switches, 3/6; pick-ups, various Clarion, etc., from 14/-; B.T.H. or Collaro gramophone motors, 32/6, with pick-up and volume control; £2/12 complete.
VAUXHALL—Scales for Lissen Skyscrapers, Lucerne stations named and metres, 2/6 pair; Cliv valve-holders, various condensers, resistors, etc.; send postcard for lists.
CASH with Order, post paid over 2/6; or c.o.d.; all goods unused manufacturers' surplus; guaranteed perfect.
VAUXHALL UTILITIES, 163a, Strand, W.C.2. Phone: Temple Bar 9338. [6007]
25 Only Special Class B Kits, comprising P.M. speaker, Multitone driver, Class B valve and holder, cost £2/17/6, to clear; 30/-.
MANY Other Bargains in Pepper's New Sales List, now available.
PEPPER, 575, Moseley Rd., Birmingham, 12. [6092]

BIRMINGHAM Radiomart Carries Most Comprehensive Stock of Guaranteed Components; our list gives hundreds of money saving lines, no junk sold.
RADIOMART—Special offer B.T.H. 1½hp. A.C. motors, 25, 50, 100 cycles, 200-250v., £2/15; D.C. ½hp., £2; soiled only.
RADIOMART—Single span formers 1in. x 2in., seven for 10d.; 100 mmfd. micros, 1/3; get our list for other gear.
RADIOMART—Igranite smoothing chokes 20/10 by 260 ohms, 100 m.a.; Stalloy core impregnated interleaved windings, 2/9.
RADIOMART—Utility screened 2-gang .0005, super bakelite, fitted Uniknob trimming disc drive, 2/11.
RADIOMART—Bargain offer; one dozen Belling Lee bakelite terminals, 5 gross assorted B.A. screws, 5/-.
RADIOMART—B.T.H. P.A. and speaker field replacement resistances, 1,000, 1,070, 2,100 ohms, 100 m.a., 1/- each.
RADIOMART—Genuine Electrad Royalty 50,000 potentiometers, 1/6; Dubilier 1 mid. 500vt., 10d.
RADIOMART—TCC 250v. A.C. equivalent 400v. D.C. working, 4x4x4 (12 mfd.), 3/9; TCC, soiled, 1,500vt., 2 mid., 2/6; 4 mid., 3/6.
RADIOMART—G5NI offers the following short wave equipment; accredited Hammarlund agents.
RADIOMART—Special offer New Western Electric solid back microphones, 2/9; Western sensitive insets, 9d.
RADIOMART—Brown beehive standoff insulators, 8d.; Frequentite valve holders, 9d.; screened frequentite anode connectors, 1/-.
RADIOMART—Super brass .0001 short wave variable, pigtail, 1/9; half amp. HW meters, 5/6.
RADIOMART—Raymart HFC, 10-100 metres, 9d.; Ormond loloss microvariables, 1/9.
RADIOMART—Microvariables 15, 40, 100 mmfd., 1/3; utility neutroverias, 1/3; 400 ohm potentiometers, 6d.
RADIOMART—Orders over 6/- post free; the square dealers.—19, John Bright Street, Birmingham. [6083]
PIONEER RADIO OFFERS Ericsson 3.1 L.F. Transformers, list price 17/6, new and guaranteed; our price 2/3, post free U.K.; Varley Constant Square Peak Band-Pass Coils, type B.P.5, complete with switch, brand new, in maker's original carton, with full instructions and diagrams, list price 15/-, our price 2/4, post free U.K.; Polar 3-gang Star Minor Condenser with trimmer, brand new, list price 18/9, our price 7/- each, post free U.K.; Collaro Electric Gramo. Motor, A.C., 200-250, with pick-up and volume control, auto start and stop, brand new, listed at £4, our price 47/6, carriage paid; Celestion Energised M.C. Speaker, 2,500 ohms, model D.C. 2054, with universal transformer, list price £2/5, our price 12/6; bankrupt set manufacturers' stock.
PIONEER RADIO, Coptic St., London, W.C.1. Museum 9606. [0425]

MISCELLANEOUS.

EVERYTHING for Movies.—Cameras and Projectors from 20/-; screens from 5/-.
ILLUSTRATED ENTERPRISES, 159, Wardour St., London, W.1 (facing Film House, Oxford St. end); not a shop, but a warehouse packed with motion-picture equipment; your inspection invited. Phone: 6889 Gerrard; free parking facilities. [5936]
EMPLOYERS are Searching for Skilled Draughtsmen and First Class Engineers, all branches; our special postal training will make you suitable.—Dept. 92, The Bennett College Ltd., Sheffield. [6068]
GUARANTEED Expert Repairs to Any Receiver, estimate free, highest quality workmanship, lowest prices; receivers taken in part exchange.—Zenith Radio Service, 17, Park St., Guildford. Phone: 1700. [0423]
AMBITIOUS Men.—Qualify for a well paid post by studying at home with the T.I.G.B. Write to-day for "The Engineer's Guide to Success," 152 pages, free, which contains the widest selection of engineering and wireless courses in the world, and shows you how to become A.M.I.E.E., A.M.I.Mech.E., A.Rad.A., etc. State branch, post or qualification that interests you.—The Technological Institute of Great Britain, 82, Temple Bar House, London, E.C.4. (Founded 1917. 19,000 successes.) [6029]

PATENT AND TRADE MARK AGENTS.

A. MATHISEN, Chartered Patent Agent; patents, designs and trade marks.—First Avenue House, High Holborn, London, W.C.1. Holborn 8950. [5284]
GEE and Co. (H. T. P. Gee), Patent Agent for Great Britain, U.S.A., Canada, etc., Mem. R.S.G.B. A.M.I.R.E.), 51-52, Chancery Lane, London, W.C.2 (2 doors from Government Patent Office). Phone: Holborn 1525. Handbook free. [0001]

—“absolutely no distortion”—

“Wireless World” Test Report

TRIX
SOUND
EQUIPMENT

for every purpose where quality reproduction is required.
19 standard types of Amplifiers in our new illustrated list, also microphones, speakers, turntables, etc.
Let us send you details and quote for your particular requirements.

THE TRIX ELECTRICAL COMPANY LTD.
 8-9, Clerkenwell GREEN, London, E.C.1
 Phone: CLERK 3014/5. Telegrams: TRIXADIO, SMITH, LONDON.

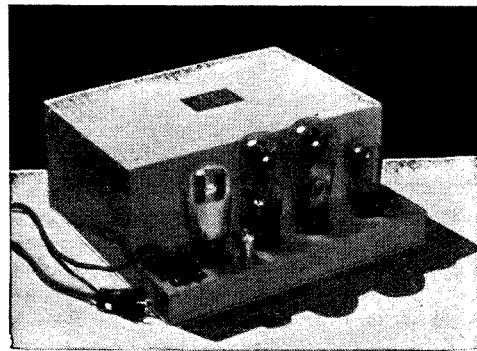

HEYBERD MAINS TRANSFORMER for the “PUSH-PULL QUALITY AMPLIFIER”

Specially designed for the “Wireless World Push-Pull Quality Amplifier” the Heyberd model W.W.8 embodies features that make the use of this model essential to the building of a first-class job. Heyberd Transformers are used and consistently recommended by all worth while Set designers.

TYPE W.W.8 - - PRICE 39/6
 Immediate delivery from stock.

Cut out this ad. and send with 3d. in stamps for 40 pp. booklet describing Transformers, Battery Chargers, etc.

F. C. HEYBERD & CO.,
 10, FINSBURY ST., LONDON, E.C.2.

NORTHAMPTON POLYTECHNIC INSTITUTE
 St. John Street, London, E.C.1.

ENGINEERING:
 Mechanical, Civil, Aeronautical, Electrical and Electrical Communication.

Full-time courses extend over four years and include two periods, each of five months, in industrial employment. Courses are recognised by the University of London and Matriculated Students are prepared for the B.Sc. (Engineering) degree.

OPHTHALMIC OPTICS:
 The course extends over two years and students are able to qualify for the Fellowship of the British Optical Association and of the Spectacle Makers' Company.

ENTRANCE EXAMINATION:
 Wednesday and Thursday, 18th and 19th July, 1934.
 PROSPECTUS of above and of all evening classes on application

REPAIRS.

MAINS Transformers Rewound; prompt service; satisfaction guaranteed; prices on request.—The Sturdy Electric Co., Wesley Terrace, Dipton, Newcastle-on-Tyne. [5992]
OLD Sets Transformed to All Mains Universal A.C.—D.C. with New High Voltage Valves, powerful, clear, hum-free reception guaranteed; prices 10/- per socket, plus price of valves; no extra parts charged for.—Sablon's Radio, 69, Sister's Ave., London, S.W.11. [5837]
REPAIRS to Moving Coil Speakers, cones and coils fitted or rewound. Eliminators and transformers quoted for. Loud-speakers, I.L. and speech transformers, 4/- each. Post free. Trade invited. Satisfaction guaranteed. Prompt service.—Loud-speaker Repair Works, 5, Balham Grove, London, S.W.12. Battersea 1321. [0394]
ELECTRIC CLOCKS.
SPECIAL Offer.—Superior A.C. main electric clock movements, 200-250v., 50 cycles, drive up to 10-inch hands; 16/6, post 6d.—Write details, Ebury Bridge Radio Co., 33, Ebury Bridge Rd. Sleane 8407. [5963]

EXTENDED PAYMENTS.

EASY PAYMENTS.—We supply you direct, by easy payments, components, accessories, and sets, any make; 10% down, balance spread over 11 months; any radio goods ordered c.o.d. despatched same day.—Send list of requirements to London Radio Supply Co. (established 1925), 11, Oat Lane, London, E.C.2. [0337]

EXCHANGE.

DEAL With the Firm that Gives You the Highest Possible Allowance in Exchange, sets or components; prompt attention and deliveries.—Mildmay Radio Exchange, Phone Clissold 5001. 24, Mildmay Grove, London, N.1. [5985]

WANTED.

EXPERIMENTAL WIRELESS—Back Numbers 75, 76, 103 to 117.—Wilkes, St. John's College, Cambridge. [6097]
SPOT Cash for New or Used Modern Components.—Economic Radio Co., 96-98, South Lambeth Rd., S.W.8. [5964]
INVENTIONS Wanted, advertiser will arrange financing, manufacturing, marketing, suitable propositions.—Write, confidence, Box 991, c/o The Wireless World. [6077]

WANTED, good class radio components, sets, meters, speakers, etc.: spot cash paid; bring or send to North London Radio Service, 84, Hampstead Rd., N.W.1. [6060]

HIGH-CLASS Radio Parts and Sets Wanted for Cash, new or second-hand, any quantity, we pay up to one-third of the retail value for class goods; send yours, stating reasonable price; cash by return (no junk, please); dealers' obsolete sets also purchased, any amount; van and representative will call for any reasonable lots.—Mildmay Radio Exchange, 24, Mildmay Grove, London, N.1. Phone Clissold 5001. [5984]

SITUATIONS VACANT.

DESIGNERS for Radio and Telephone Apparatus Required, first class men only need reply; state age, experience, salary expected.—The Plessey Company, Ltd., Vicarage Lane, Hford [6071]
THOROUGHLY Experienced Man, to run technical side of relay company; salary and share of profits; investment after trial if desired; state experience, salary, confidential.—Box 912 c/o The Wireless World. [6082]
YOUTHS trained for all branches wireless profession. Britain's leading college. Training fee payable after appointment. Students boarded. London representative for interviews. Prospectus free.—Wireless College, Colwyn Bay. [0388]

AUCTION SALES.

WITHOUT RESERVE.
 By order of the Receiver and Manager, L. Gilbert, Esq., re Yagerphone, Ltd. (in Liquidation) and others.
PONDERS END, MIDDLESEX.
MESSRS. JOSEPH HIBBARD & SONS
 will Sell by Public Auction upon the premises, in Lea Valley Road, close to Ponders End Station (L. & N.E. Rly.), on **TUESDAY, JULY 24th, 1934**, at 1 o'clock.
STOCK AND PLANT OF RADIO MANUFACTURERS, including 1,300 RADIOGRAM, RADIO, GRAMOPHONE CABINETS in Oak Walnut and Mahogany, comprising Pedestals, Consoles, Sideboards, etc. 1,000 RADIO and GRAMOPHONE TABLE CABINETS, WIRELESS SETS, RADIO GRAMOPHONES and GRAMOPHONES PARTLY FITTED, SPEAKER CABINETS, LARGE QUANTITY OF STORES OF WIRELESS and GRAMOPHONE COMPONENTS.
PLANT, including:—
 Valve-making Equipment, Spraying Cabinets, Coil Winders, Bakelite Press and Moulds, 5ft. and 1 3/4 ft. Dimension Saw Benches by Ransome, 30in. Panel Planing Machine, 3 Dovetailing Machines, Automatic Hack Saw, 2 Metal Guillotines, Emery Grinder, Metal Rolling Machines, 4 Vertical Drilling Machines, Palmers Cramps, Electric Motors, Shafting, and Office Furniture.
 On view day prior to sale and sale morning. Catalogues can be obtained from L. Gilbert, Esq., 306-308, Euston Road, N.W.1. or from the Auctioneers' Offices at 15, NEWINGTON GREEN ISLINGTON, LONDON, N.16.

BARGAIN

ATLAS S.G.3 A.C. SET
 LIST PRICE £9-17-6 BARGAIN PRICE £5-19-6
 Model 334. Variable-Mu S.G. Detector and Power Valves, Westinghouse Rectifier, Full-vision illuminated Wavelength Scale, Sockets for Pick-up and extra Speaker, A.C. Mains, 200/250 volts, 40/120 cycles. Complete with Valves, Speaker and Cabinet. Guaranteed by Peto-Scott BRAND NEW in Manufacturer's Sealed Carton. Ready to play.
 or Yours for **11/6**
 Balance in 11 Monthly Payments of 11/6.
PETO-SCOTT CO., LTD.,
 77, City Road, London, E.C.1. Phone: Clerk. 9406/7.
 West End Showrooms: 62, High Holborn, London, W.C.1

INDEX TO ADVERTISEMENTS.

PAGE	PAGE	PAGE
Aerialite, Ltd.	Dubilier Condenser Co. (1925), Ltd.	Pickett's
Arden Agency	Electradix Radios	Radio Resistor Co., Ltd.
Baker's "Selhurst" Radio	Ferranti, Ltd. 5 & Back Cover	Rich & Bundy, Ltd. 4
Barber & Colman, Ltd. 8	Fluxite, Ltd. 6	R.I., Ltd.
Bell & Black, Ltd. 8	Garrard Engineering & Manufacturing Co., Ltd. iii	Savage, W. Bryan
Belling & Lee, Ltd.	Hartley Turner Radio, Ltd. 4	Shaftesbury Supplies
Benjamin Electric, Ltd. 1	Hayberd, F. C., & Co. 7	Sound Sales, Ltd. 8
Birmingham Sound Reproducers, Ltd. Inside Back Cover	Lectro Linx, Ltd.	Stratton & Co., Ltd. 8
Black, Alexander, Ltd. 8	London Radio Supply Co. 4	Telegraph Condenser Co., Ltd. Front Cover
British Institute of Engineering Technology 2	Lyons, Claude, Ltd.	Telephone Manufacturing Co., Ltd.
British Radiophone Co., Ltd. Front Cover	Neill, James, & Co. (Sheffield), Ltd. 2	Telsen Electric Co., Ltd. Front Cover
British Rola Co., Ltd. 3	Nello, Ltd. iii	Trux Electrical Co., Ltd. 7
British Thomson-Houston Co., Ltd.	Northampton Polytechnic Institute	Universal Radio Co. 8
Bryce, W. Andrew, & Co. iii	Pepper, Trevor	Watmel Wireless Co., Ltd. 6
Colvern, Ltd. Front Cover	Peto-Scott, Ltd. 7	Waingrove & Rogers, Ltd. (Polar) Inside Back Cover
Cossor, A. C. Ltd. Inside Front Cover	Philco Radio Corporation, Ltd. 8	Wright & Weaire, Ltd.

EDDYSTONE COIL UNITS
for the SINGLE SPAN RECEIVERS

EddyStone Slow Motion Reaction Condenser, No. 957, '0002 mfd. Price 6/-

STRATTON & Co. Ltd., Bromsgrove St., Birmingham
London Service Depot: WEBB'S RADIO STORES, 14, Soho St. Oxford St., W.1. Telephone: Gerrard 2089.

I.F. UNITS. Set of four, each coil to specification, bracket mounted on EddyStone Microdenser and in heavy gauge polished aluminium screening can. 35/- the set.

OSCILLATOR UNIT. Coil to specification mounted on Polar type "E" condenser in heavy gauge polished aluminium screening can. Price 10/-.

AERIAL COILS. L.1 and L.2 on bakelite former to specification. Price 2/- the pair.

COILS ONLY. Per set of seven, wound to specification and testing. 12/6 the set.

EDDYSTONE
HIGH GRADE COMPONENTS

"SHAKEPROOF" LOCK WASHERS AND LOCKING TERMINALS

Used by all the Leading Set Manufacturers.

The twisted teeth bite into the metal and prevent "slacking off." The more the vibration the tighter they grip.

ASK YOUR DEALER FOR "SHAKEPROOF"

Manufactured by **BARBER & COLMAN LTD., Brooklands, MANCHESTER.** Dealers and factors enquire to Wm. CLARK (Spare Parts) Ltd., 5, Marshalsea Road, London, S.E.1.

HIRE YOUR MUSIC

Fully Equipped Public Address Van Sent Anywhere in British Isles.

RADIO, MICROPHONE AND GRAMOPHONE AMPLIFIERS FOR HIRE giving exceptional quality and volume, suitable for Dances, Sports Meetings, Fetes, etc.

McMICHAEL DUPLEX PORTABLE SETS FOR HIRE 15/- WEEK, 52 6 MONTH. SERVICE AND REPAIRS. (EST. 1925.) DESIGNS AND TESTING.

ALEXANDER BLACK LTD., WIRELESS CONSULTANTS, 55, EBURY STREET, LONDON, S.W.1. Sloane 6129 (2 Lines).

A SPORTING TREAT.

TWO GUIDE BOOK CATALOGUES sent free on receipt of 6d. for postage, giving endless tips and information for shooters and trappers. The books also tell how to camp, pack and cook, as well as climb and swim. Everything from a tent peg to a trailer at lowest prices. 100 pages profusely illustrated on Art paper. Write to-day, mention this paper.

EELL & BLACK, LTD., 17, Claremont Street, Glasgow West.

Electradix Bargains PORTABLES For the Holidays

At phenomenally low prices, All guaranteed and with valves, speakers, etc., in good order.

ROLLS CAYDON, brown hide case, slightly used 35/-.

ORMOND Electra Suitcase Portable, drum dials, blue leatherette, plugs for extra speaker. Really fine set, £3. Brand new **BARKER** portable, leatherette suitcase model. Finest tone, £3 10s. **PORTABLE SUPERHET** 6-valve French model in green leatherette with folding frame aerial, £3 10s. **PORTABLE INTERNATIONAL**, Vert. mahog. cabinet, as new, 45/-.

EDISON BELL 2-valve Transportable, vert. mahog. 30-**SUITCASE CABINETS** for constructors, fitted aerial frame, panel speaker unit and fret, 18/6. Unfitted 9 3/4" Polished Mahog. Transportable Vert. CABINETS, only 12 3/4. **PORTABLE ANNOUNCERS.** FAY set of stand microphone, trans. and controls; 3-valve battery, trans. coupled. Amplifier; suit band, £4. Ditto set with amplifier R.C. coupled, £4. Write for Portable Bargain List "W."

ELECTRADIX RADIOS
218, Upper Thames Street, London, E.C.4.
Tele: Central 4611.

Wherever Moving Coil Speakers are PRAISED AND ADMIRING, THE NAME **BAKER** IS ON THE TIP OF THE TONGUE, RECOMMENDED AND SOLD BY DEALERS EVERYWHERE.

BAKER SELHURST RADIO LTD., SUSSEX ROAD, CROYDON

AMERICAN TYPE VALVES

Philco Valves — all with a definite guarantee — are suitable for all American makes of radio sets.

Philco Type 80—Full Wave rectifier 350 volts, 125 m/a —Price 8/- 6A7, 2A7 and 1A6 Heptodes at 16/-

Write for Full Price List or for price of special type required giving the maker's type number.

PHILCO

The Philco Radio and Television Corporation of Gt. Britain Ltd., Valve Dept., Perivale, Middlesex. Phone: Perivale 3344

Specified by the Experts **SOUND SALES**

TYPE PP QA MAINS TRANSFORMER 60-.

Specified for the "W.W." Quality Amplifier

TRANSFORMERS. CONVERSION UNITS. CHOKES.

Sound Sales Ltd., Tremlett Grove, Highgate, N.19

LIQUIDATORS SURPLUS STOCK ALL STOCKS TO BE CLEARED

Receivers, Portables, 5v., 15v., S.G.A.'s 20-
A.C. D.C. Superhet Westector A.V.C. Westinghouse Rectifier £4 -
Car Radios, Peerless, list 18 sets £3 10 -
D.C. Radiogram, demonstration model £7 19 6 -
D.C. Radiogram, £7 10 - And another £6 10 -
A.C. Radiogram, Edison Bell £3 10 -
A.C. Radiogram, Lissen £5 -
A.C., R.A.P. Superhet, with Garrard Automatic Record Changer in maker's wrappings £15 -
Battery 3-Valve Kits, in cabinet 12 6 -
Steel Case 31-watt Amplifiers, with B.V.A. Valves and moving coil speaker £8 10 -
Speakers, Amplion, 2,500, 7,500, and 40 ohms 10 -
E. and A., 2,500, 7,500 and 10,000 18 -
Motor P.M. Speakers, with heavy sensitive Darwin Magnet, List 49 6 - Our price 16 -
P.A. Types, Brown and R.K. 30 - each
Large R.C.A., £5 - Peerless A.C. Field, with transformer, £3 -
Components, Convertors, Croydon Engineering, Input 200-240 D.C. 100 watt type complete soundproof case with smoothing equipment £6 10 -
E.D.C. Converter 240 D.C. input, 200 watts £8 10 -
Microphones, Ultrax, as reviewed "W.W." 12 6 -
De Luxe Model, spring surround 15 -
Special Reisz Pattern, for P.A. work 50 -
Volume Controls 30,000 to 100,000 1/2" C.A.V. Unspill. Accs. 12 -
O.M.B. Toggle Switches, 9d. Volt-ammeters 10 -
4 Mfd. Manbridge Type 1.9. T.C.C. 1 Mfd., 1,500 volt working, 5 - each
Figured Walnut Veneer Radiogram Cabinets, 35 - each, New Time Switch, any reasonable offer. Ferranti Multi Range Test Set, 2 meters, with micro scale incorporated £4 10 -
Ferranti L. input and output Trans. from 5 -
Light Sensitive Cells, suitable for burglar alarms and television, List 27 6 10 - each
3- or 4-Gang Polar 0.0005 Condensers 6 - each
Ekeo D.C. All-power Unit £2 10 -
Ekeo Mains Trans. 325-0-325 10 -
A.C. Chassis with B.V.A. Valves, heavy sensitive Darwin Magnet, List 49 6 £3 10 -
Complete Chassis, partly assembled £1 10 -
Chassis only 2 6 -
Hundreds of cabinets, thousands of coils, all various makers, past and present kinds (most types American valves). We have a special list prepared for trade only.

UNIVERSAL RADIO CO., 219-221, City Rd., E.C.1.
Telephone: Clerk 6719.

Amplifiers and P.A. Equipment

of the highest standard
of performance

State your requirements
and let us quote.



BIRMINGHAM SOUND REPRODUCERS LTD.

CLAREMONT WORKS, OLD HILL, STAFFS.
Phone: Cradley Heath 6370. Grams: Electronic, Oldhill.

WIRELESS DIRECTION FINDING

and DIRECTIONAL
RECEPTION

(1927)

By R. KEEN, B.Eng. (Hons.)

Second Edition

THIS volume deals with the principles of the subject and the constructional details of direction-finding installations, and includes some information concerning aircraft equipment. It describes the principles of Direction and Position Finding in such a way that the subject may be grasped easily by engineers tackling this field of wireless work for the first time. Numerous photographs and diagrams are included.

Price 21/- net. By post 21/9

From leading booksellers or
direct from the Publishers:

ILIFFE & SONS LIMITED

Dorset House, Stamford Street, London, S.E.1

w.w.68

POLAR SPECIFIED ★ WITHOUT ALTERNATIVE ★ for the UNIVERSAL SINGLE-SPAN

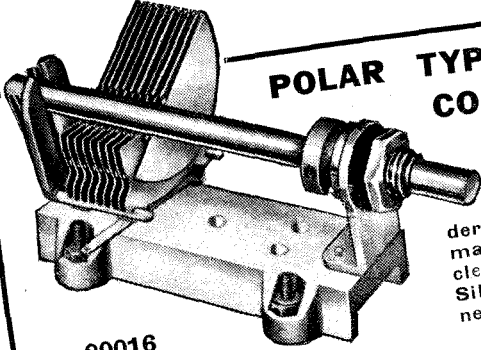

**POLAR TYPE 'E'
CONDENSER**

Constructed on
STEATITE
base. All banks
of vanes sol-
dered together and
made of chemically
cleaned hard brass.
Silent rotor con-
nections.

.00016
5/-

Also made in 2-gang, Price 10/6

SEND FOR
POLAR
CATALOGUE

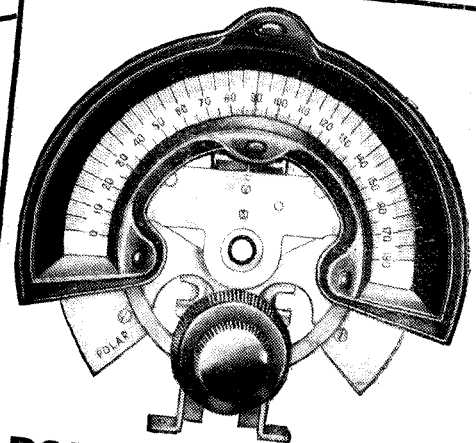

**POLAR MICRO-DRIVE
SEMI-CIRCULAR**

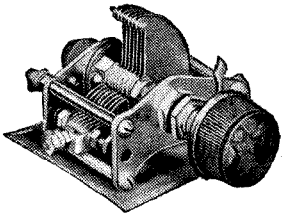

**POLAR TYPE Q.J.
SLOW MOTION REACTION
CONDENSER**

Constructed entirely in
brass. Ball
bearing spin-
dle. Moving
pointers. Sup-
plied with knob

.0002
6/-

With two reduction ratios,
100 to 1 and 7 to 1, each
operated independently by
concentric knobs. Bevel-
led scale marked in 0-180
degrees. Moulded escut-
cheon. Lamp holder.
Complete with
baseboard fix-
ing bracket.

7/9

Also made in "Arcuate" and "Hori-
zontal" types at 7/9 and Moving
Scale at 6/6.

WINGROVE & ROGERS LTD.
188/189, STRAND, LONDON, W.C.2

Phone:
Temple Bar 2244.

Works: Old Swan,
— LIVERPOOL. —

5266

THE NEW LANCASTRIA

12 GNS—IS THAT ALL?

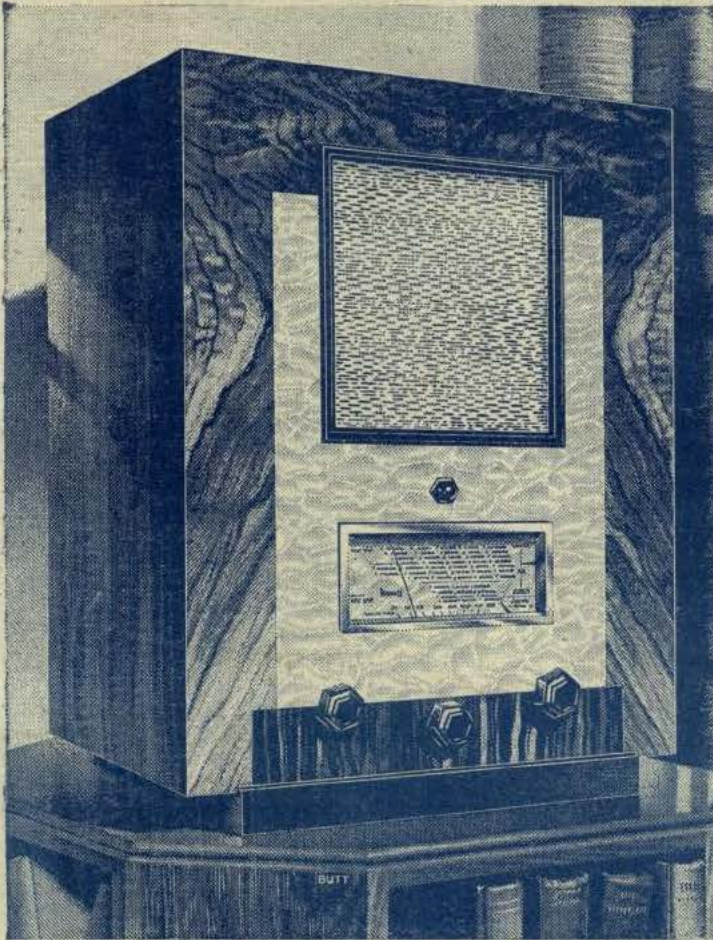

Quilted Maple, Figured Walnut and Macassar Ebony . . . three rich woods of different colours and grains, make this new Ferranti the most beautiful set ever offered to the public at a price as low as 12 gns. The simple but elegant design of the cabinet is sure to be popular: No

one is likely to hate it and it will harmonise with almost any scheme of modern or period decoration. You will not be saying in a year's time "It's out of date." A good design is never out of date! Note the recessed base, for carrying. No unsightly projecting handles!

Pay 3 gns. less than you intended —and get a better set

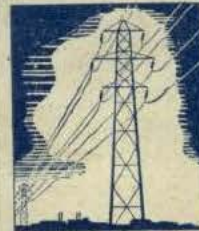

A NAME YOU CAN TRUST: AND IT COSTS YOU NO MORE!

When you buy a radio set (or anything else, for that matter) bearing a famous name, you expect to pay quite a bit extra for the name. And in most cases you *do* pay extra. But in the case of Ferranti radio, you definitely don't! Consider the Lancastria's price of 12 gns. in relation to its technical specification, its beautiful cabinet and dial and its masterly finish—and then ask yourself how it's done. Other makes of set in the Lancastria class cost 15 gns. and more. Ferranti can knock three guineas off that price because of their immense manufacturing resources; because the Lancastria superhet is built in the same factory that produces giant Ferranti apparatus for the vast electrical schemes of modern Britain.

SPECIFICATION: An all-modern, all-electric (A.C. Mains) Superhet, without a single equal at its price. Powerful 2½ watt output. Automatic Volume Control. Continuously variable tone control. Ferranti moving coil speaker. Floating chassis to obviate resonance. Local-distance switch to prevent 'swamping' from local station. One knob tuning. 'All-in' dial, framed in chromium and brilliantly illuminated, incorporating station names and wavelengths, Electric Tuning, and visual indications of the waveband, the degree of volume and the relative shade of tone. Lucerne selectivity on Lucerne station dial. Ferranti valves. Terminals for extra speaker (with cut-out switch for internal speaker). Mains aerial. Provision for Gramophone pick-up. Cabinet of Quilted Maple, Figured Walnut and Macassar Ebony. Dimensions: 19½ in. high by 14½ in. wide and 9 in. deep .. 12 gns; or 32/- deposit and 12 monthly payments of 20/2d.



Wonderful Chromium Visible Control Dial which shows you everything you want to know. The new Ferranti Chromium frame dial on which station volume and tone are all visibly indicated. No need to wonder what's happening as you turn the controls; you can see for yourself on the dial.



NO OTHER SET AT THIS PRICE GIVES YOU ALL THESE STAR FEATURES

- ★ ★ Electric Tuning.
- ★ Names and wavelengths on the dial.
- ★ ★ ★ Full automatic Volume Control.
- ★ Balanced components (253 components—every one of them made by Ferranti).
- ★ Speaker Cut-out switch, and terminals for extension speaker.

And that's not all! For complete descriptions of the Ferranti range of electric and battery superhets fill in your name and address on this Request Slip and post to Ferranti at Hollinwood, Lancs., or Bush House, London.

FERRANTI

FERRANTI LTD., HOLLINWOOD, LANCS., or BUSH HOUSE, LONDON, W.C.2

W.W.3

NAME :

ADDRESS :

Please send me your catalogue giving fullest particulars of the Ferranti 1934 range:

The Wireless World

4^D

THE PRACTICAL RADIO JOURNAL

with Complete Foreign Programmes

Friday, July 20th, 1934.

TELSEN D.R. TRANSFORMER

—the L.F. Transformer with a STRAIGHT LINE



CHARACTERISTIC which gives UNIFORM AMPLIFICATION over the entire range of audio-frequencies. The spaced layer windings are impregnated with a non-hygroscopic material of very low specific inductive capacity which absolutely eliminates all possibility of shorted turns or breakdowns due to large magnetic surges

D.R.3 (ratio 3-1) 8'6
D.R.5 (ratio 5-1)

Announcement of the Telsen Electric Co., Ltd., Aston, Birmingham:

TELSEN FOR EVERYTHING IN RADIO

ANOTHER AMAZING ADVANCE



The NAME DUBILIER on a CONDENSER



is your guarantee of SATISFACTION

Dubilier Condenser Co. (1925) Ltd., Ducon Works, Victoria Rd., N. Acton, W 3.

POWER

H.T. FROM L.T.
D.C. TO A.C. —
MACHINES TO MEET EVERY NEED



WRITE FOR FREE BOOKLET to ROTAX LTD. RADIO DEPT. 1 WILLESDEN LONDON NW10

**SEE
THIS?
T.C.C.**

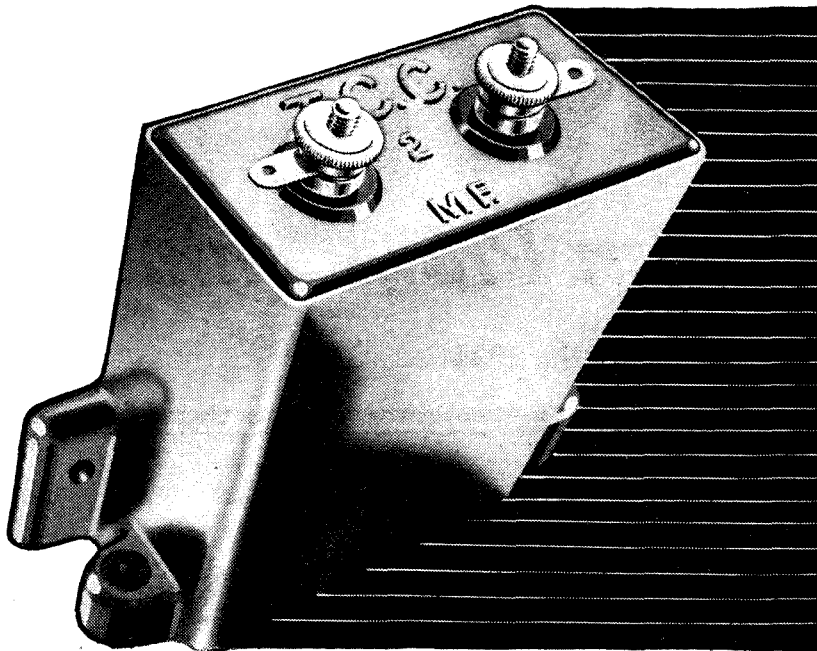

it means **SAFETY**
at no extra cost •

Here's a non-inductive 2 mfd. T.C.C. Type 50 paper condenser—specified for 200v. D.C. Working. D'you see the initials T.C.C.? . . . they mean perfect safety. Use it with 200v. D.C. across it (and, unofficially, shall we whisper?—a little more too!) and you know it won't let you down. The condenser plus this security costs you 3s. 6d.—not much to be sure.

It's the same throughout the T.C.C. range; the Type 141 is specified for 2,500v. D.C. Working—and it will—it bears the initials "T.C.C." Look to it that the condensers you buy are rated at the right voltage—then look to it that they carry the T.C.C. initials—then you've got the world's finest condensers—and at no extra cost.

T.C.C.
ALL-BRITISH
CONDENSERS

There is a new illustrated price list—just ready. If you have not received a copy from your Dealer a p.c. to us will bring you one.

THE TELEGRAPH CONDENSER CO. LTD., WALES FARM RD., NORTH ACTON, W.3

EVERY TEST

A.C. CURRENT & VOLTAGE

& D.C. CURRENT, VOLTAGE & RESISTANCE

WITH ONE INSTRUMENT

Greater Accuracy & Ease than ever

The unrivalled testing facilities of this famous instrument have been still further extended by the addition of two further ranges of A.C. voltage readings for checking mains voltages with absolute accuracy on full scale deflection. The Universal Avometer retains its leadership as the world's most widely used and most accurate combination measuring instrument

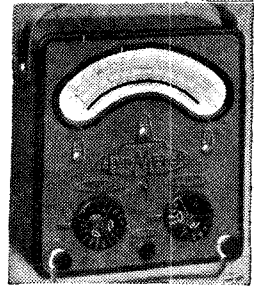

BRITISH MADE

12 Gns. *Deferred Terms if desired.*

THE MASTER THE 36 RANGE UNIVERSAL **AVOMETER** REGD. TRADE MARK **SERVICING INSTRUMENT**

13-range D.C. Avometer **8 Gns.**

Write for descriptive Folder:—

The Automatic Coil Winder & Electrical Equipment Co., Ltd., Winder House, Douglas St., London, S.W.1
Telephone: Victoria 3404-7.

NICORE
TUNING COILS

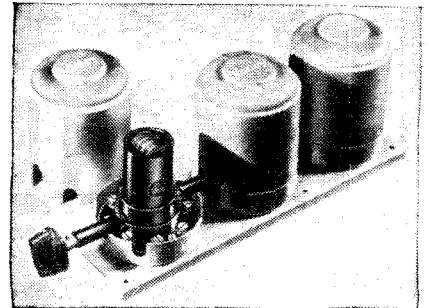

Varley Nicore Coils mark the biggest advance in radio tuning. Consistency has been the great aim with which they have succeeded with an even greater efficiency than was thought possible.

Write for Free Literature.

Varley
(Proprietors, Oliver Pell Control Ltd.)

Advt. of OLIVER PELL CONTROL LTD.,
103 Kingsway, London, W.C.2

The Wireless World

THE
PRACTICAL RADIO
JOURNAL
24th Year of Publication

No. 777.

FRIDAY, JULY 20TH, 1934.

VOL. XXXV. No 3.

Proprietors: ILIFFE & SONS LTD.

Editor:
HUGH S. POCOCK.

Editorial,
Advertising and Publishing Offices:
DORSET HOUSE, STAMFORD STREET,
LONDON, S.E.1.

Telephone: Hop 3333 (50 lines).
Telegrams: "Ethaworld, Watloo, London."

COVENTRY: Hertford Street.

Telegrams: "Cyclist, Coventry." Telephone: 5210 Coventry.

BIRMINGHAM:

Guildhall Buildings, Navigation Street, 2.
Telegrams: "Autopress, Birmingham." Telephone: 2970 Midland (3 lines).

MANCHESTER: 260, Deansgate, 3.

Telegrams: "Iliffe, Manchester." Telephone: Blackfriars 4112 (4 lines).

GLASGOW: 26B, Renfield Street, C.2.

Telegrams: "Iliffe, Glasgow." Telephone: Central 4857.

PUBLISHED WEEKLY. ENTERED AS SECOND CLASS MATTER AT NEW YORK, N.Y.

Subscription Rates:

Home, £1 1s. 8d.; Canada, £1 1s. 8d.; other countries, £1 3s. 10d. per annum.

As many of the circuits and apparatus described in these pages are covered by patents, readers are advised, before making use of them, to satisfy themselves that they would not be infringing patents.

CONTENTS

	Page
Editorial Comment	33
Audio-Frequency Test Oscillator ..	34
Practical Hints and Tips.. ..	37
Single-Span Developments.. ..	38
Letters to the Editor	40
Bandit Tracking from the Air ..	42
News of the Week	44
FOREIGN PROGRAMME SUPPLEMENT, pp. I—XXIV	
Broadcast Brevities.. ..	45
The Art of Ganging—VII ..	46
Unbiased	48
G.E.C. Battery Compact Three ..	49
New Apparatus Reviewed.. ..	50

EDITORIAL COMMENT

Engineering Monopoly

Sets Designed by Valve Manufacturers

OUR American contemporary *Electronics*, in the issue of June last, comments upon a situation which has grown up in America under which practically all the research in connection with new receivers is carried out not by set manufacturers but by the manufacturers of valves, the offer of complete design information being used as an inducement to obtain the set manufacturer's contract for the supply of valves.

Our contemporary points out that such concentration of industry engineering in a few places must result in technical stagnation and a tendency towards standardisation of receivers. The smaller manufacturers, in particular, are attracted by the saving in technical staff. It is pointed out that under such an arrangement technical competition will die out and no stimulus will exist to encourage the manufacturer to improve the technical excellence of his products.

The Position Here

It might seem that the troubles of American manufacturers are not matters of great concern to us over here. But we would point out that very much the same state of affairs is beginning to influence our own manufacturer's designs. The valve makers are already supplying so much circuit information and receiver design data that the apparent necessity for most set manufacturers to maintain their own research departments is disappearing. Fortunately, however, most of our progressive receiver firms are wise enough to realise that American

methods may not prove satisfactory here and that unless they are willing to enter into the neck-and-neck race for price reduction with mass-produced sets, and, what is extremely important, are fitted to compete along these lines, then originality of design of receivers is the alternative which is open to them to attract the interest of the public, and on which all but the biggest manufacturers must largely depend.

Friendly Relations

The B.B.C. and the Public

THE B.B.C. is an autocratic body. For that let us be thankful. The record of the B.B.C. seems to indicate that broadcasting as conducted in this country provides one of those rare examples of autocracy as a good thing. But the B.B.C. should not abuse, however unintentionally, its peculiar position of being able to give listeners what is considered to be good for them and being virtually independent of public opinion.

When we had occasion in a recent leader to draw attention to the fact that the B.B.C. earns unpopularity by propaganda put forward in such a way that listeners are taken to task, we did not intend to convey that such broadcasts ought not to take place when the necessity arises, but rather that the proper Government department or authority should undertake the broadcast and not the B.B.C. themselves.

The public accepts instruction in good behaviour from a proper authority but resents it from an interfering body self-constituted as an authority fitted for the task. It is not to the substance but the manner of these broadcasts that exception is taken, and it seems a pity that the B.B.C. should thus incur unpopularity unnecessarily.

Audio-Frequency TEST OSCILLATOR

Part I.

Design and Construction of Models for Battery and A.C. Mains Supplies

By

M. G. SCROGGIE, B.Sc., A.M.I.E.E.

SOME months ago the B.B.C. aroused considerable interest among listeners who are desirous of good reception by transmitting a number of test signals at various frequencies in the audible scale. It was possible by means of these to estimate very roughly by ear the uniformity of the receiver's response, or, by the use of a valve voltmeter or other measuring device, to draw a curve showing the response more accurately.

Having thus vouchsafed a brief sip at the cup of knowledge the B.B.C. hastily snatched it away, and no amount of unsatisfied thirst has caused them to relent. This is surprising when their avowed concern is for the highest standard of reception by listeners.

As there is no definite assurance that valuable tests of this nature will not continue to be withheld, keen experimenters have been asking whether it is possible to make the apparatus for carrying out their own tests whenever desired. Unfortu-

nately the design of an oscillator capable of giving a pure test signal at any frequency from, say, 50 to 10,000 cycles per second is an extraordinarily complicated matter, and the apparatus usually costs at least £100. For the majority of frequency tests, such as those on transformers, parallel-feed couplings, output units and complete amplifiers of one or more stages, it is not essential to provide a continuous variation of frequency, and curves of quite satisfactory accuracy can be drawn from a number of readings at fixed frequencies.

The oscillator to be described gives 15 or more frequencies, distributed fairly evenly from 50 to 10,000 cycles; the output can be kept reasonably free from harmonics, and the construction is not very elaborate or costly. The test signal can be varied from zero up to about 16 volts peak (9 volts in the battery-driven model) and is therefore enough for fully driving most modern output valves.

The oscillator itself works on the principle of the dynatron, that is to say, it makes use of the curious hollow in the characteristics of most screen-grid valves

An audio-frequency oscillator is indispensable to the radio experimenter desiring exact knowledge regarding the behaviour of detector and L.F. circuits, etc. The dynatron screen-grid oscillator gives a stable and pure waveform, and is simple to construct and adjust.

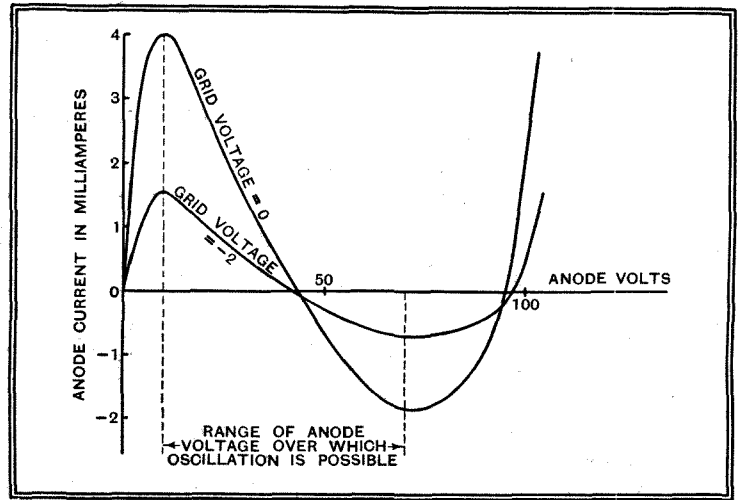

Fig. 2.—The slope of the negative resistance region of a dynatron oscillator is controlled by the grid bias.

when the anode voltage is lower than the screen voltage. The several advantages of this will become apparent later, but in the meantime it is perhaps sufficient to note that no reaction coil or other auxiliary device is necessary in order to set up oscillation.

Choice of Valves

An attempt to couple this oscillator directly to the apparatus under test would be liable to shift the frequency, or to stop oscillation altogether, so another valve is interposed to act as a sort of buffer, preventing the circuit to which it is applied from having any effect on the oscillator proper.

The most suitable valves for both purposes are of the indirectly-heated A.C. type. A completely mains-driven outfit is described, but as a large part of this consists of equipment for a supply at 100 volts it is suggested that in many cases it may be more economical to substitute an ordinary 100-volt H.T. battery, and to run the heaters alone from a comparatively inexpensive transformer, or even a 4-volt battery if it is capable of delivering two amperes.

In case the use of A.C. valves is impracticable, an alternative scheme is shown, designed expressly for battery drive. The output voltage is about half that of the A.C. model, and its oscillator valve may require selection if it is to

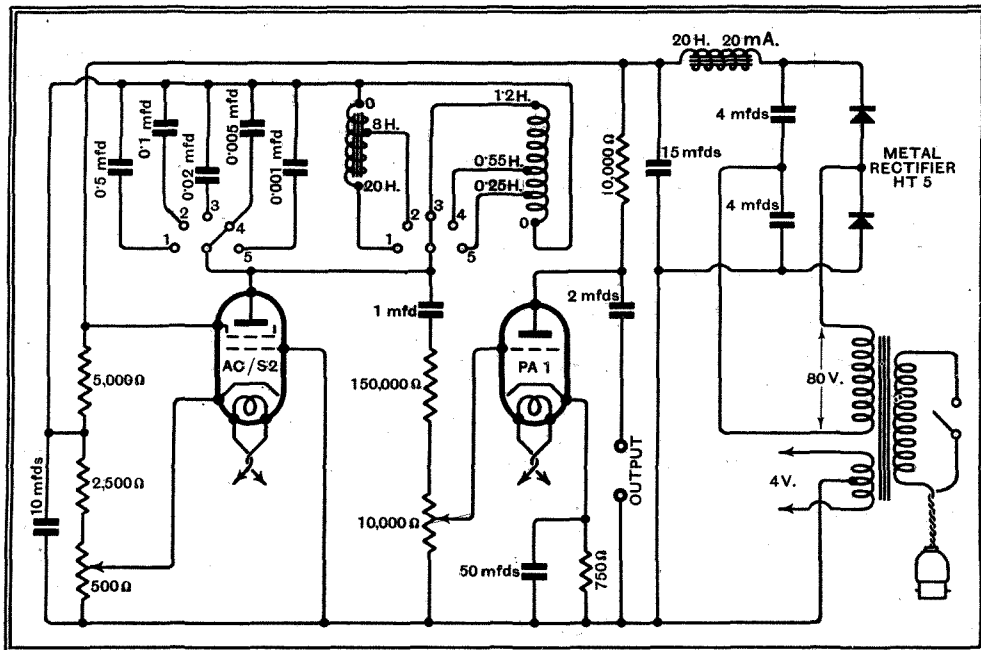

Fig. 1.—Complete circuit diagram of audio oscillator for A.C. mains.

Audio-Frequency Test Oscillator—

oscillate satisfactorily at all the desired frequencies.

Fig. 1 shows the circuit of the A.C. model. The power supply needs no explanation, except perhaps to call attention to the use of a large smoothing condenser having the double object of minimising hum (which might give appreciable false readings) and preventing interaction between the two valves. The screen of the oscillator is fed straight from the 100-volt supply, and the anode from a potential divider which gives it 38 volts. It is important to adhere to the specified values of resistors throughout, with reasonable accuracy, for the signal voltage is directly dependent on them.

Oscillation Control

The lower portion of the potential divider consists of a 500-ohm potentiometer which is used to put a positive bias on the cathode, of between zero and about six volts, or, in other words, a negative bias of that amount on the control grid. This adjustment has the effect of controlling the steepness of the dynatron slope of the valve (Fig. 2). When the negative resistance indicated by the steepness of the slope exceeds the positive "dynamic resistance" of the oscillatory circuit, oscillation is maintained. If the negative bias is still further reduced, the amplitude of oscillation increases only slightly, owing to the limiting effect of the sharp upper bend of the valve characteristic. What does happen is that the harmonics increase very greatly, producing a bad waveform, and the frequency is shifted to an appreciable extent.

The correct adjustment of the bias control knob is therefore that which just causes oscillation to be maintained at nearly the maximum amplitude. When this is correct the amplitude and frequency of the signal are both very con-

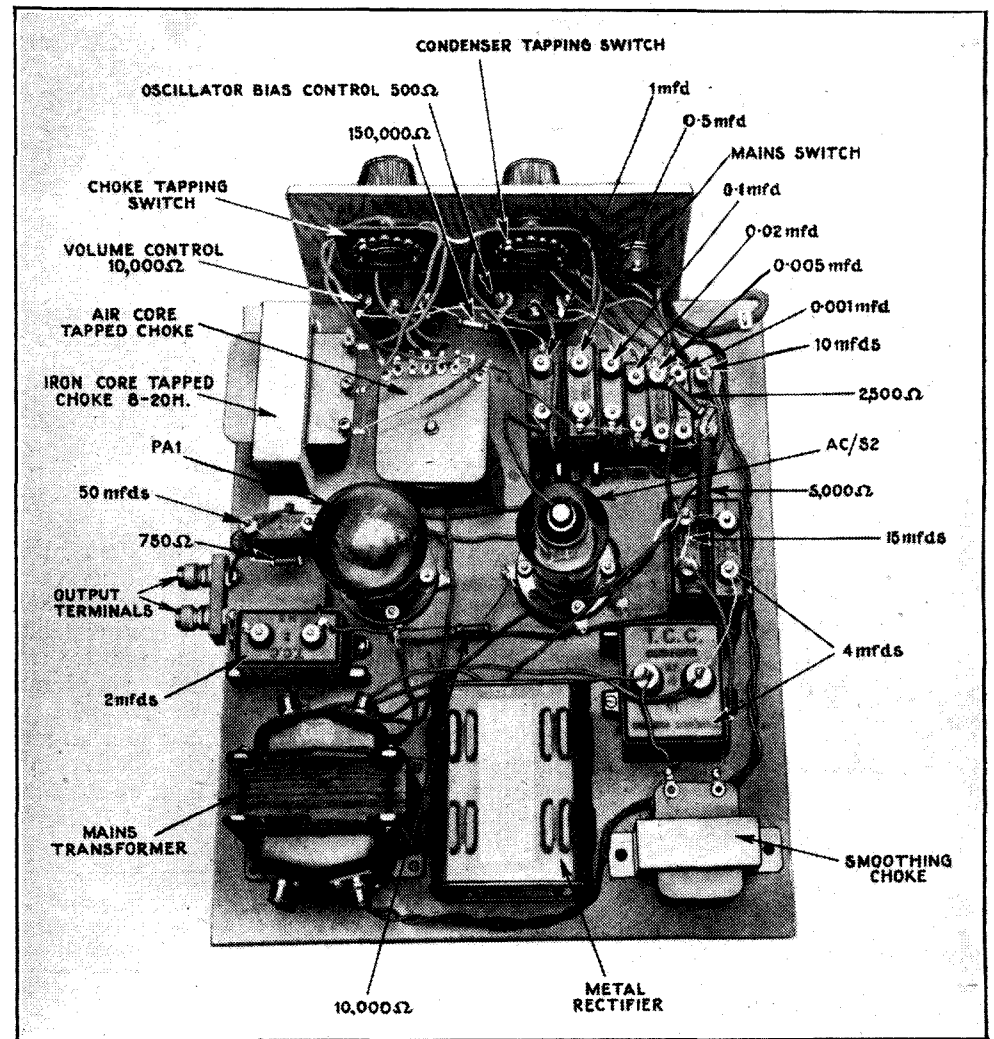

General view of experimental oscillator showing suggested layout of components.

stant and unaffected by reasonable supply voltage variation, and the waveform is extremely pure.

The Mazda AC/S2 valve is particularly good as an oscillator, because of the exceptionally large range of negative resistance corresponding to a moderate range of bias adjustment.

The oscillatory circuit consists of two tapped chokes and five condensers, selected by a pair of five-way switches.

The chokes are supplied especially for this purpose by Wright and Weaire, and have been designed so that no value of anode current up to at least five milliamps appreciably alters the inductance. The condensers should be of a thoroughly reliable make, as it is important that the capacities should be correct and should stay correct.

The peak value of oscillation, as already implied, is approximately the difference between the anode supply voltage and the upper bend voltage, which is usually about eight; and in this case is therefore 30 volts. This is far too much to apply to the grid of the next valve, so by means of another potential divider (fed through a 1 mfd. blocking condenser) anything up to one-sixteenth of the total, or approximately two volts peak can be used. The 10,000-ohm potentiometer has a "logarithmic" or graded element, so that adjustment of the lower signal voltages is not unduly critical.

The Output Stage

Bias for the separator valve is provided by the usual cathode resistor, shunted by a 50 mfd. condenser to prevent feed-back. The output is a resistance parallel-feed system. The micromesh P.A.1 valve has been chosen for this position because of the exceptionally low internal resistance in conjunction with high amplification, which enables a reasonably high undistorted signal output to be obtained in spite of the low H.T. The output system shown can be used to feed any circuit with an impedance of not less than 5,000-10,000 ohms, and delivers approximately 20 milliwatts.

The whole apparatus may be assembled in any convenient form, and the precise

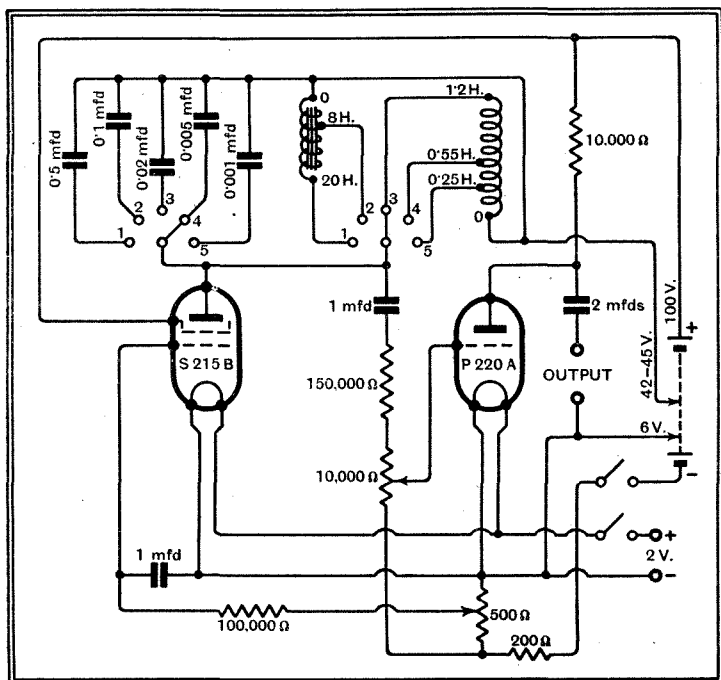

Fig. 3.—Battery version of the dynatron audio oscillator.

Audio-Frequency Test Oscillator—

layout is not important, except that the chokes (oscillating and smoothing) and transformer must be spaced apart or oriented so that there is no close coupling between them.

In the battery version (Fig. 3) the anode

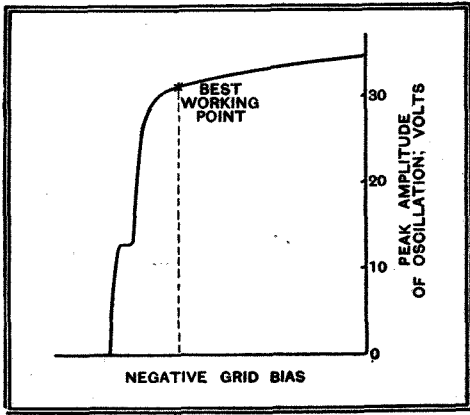

Fig. 4.—Graph showing correct operating point in relation to grid bias.

supply potential divider has been replaced in the interests of economy by a tapping on the battery. As six volts are used at the negative end for bias purposes, the tapping should be at 38 plus 6, or about 44 volts. The nominal 42 volts tapping is the nearest when the battery is fresh; after it has run down a little the plug may be shifted to 45.

The bias potentiometer has been arranged to discharge the bias cells of the battery at about the same rate as the main body. Apart from the supply details and the valves the components and adjustments are identical with those of the A.C. oscillator.

Initial Adjustments

To check up the oscillator when completed, connect the output terminals to a pair of phones or to the pick-up terminals of a receiver and switch on. The amplitude control must, of course, be set to some position other than zero, and the bias control can be started at zero bias. At this setting there should be no difficulty in obtaining oscillation at any settings of the switches with the iron-core choke in circuit (inductance switch at

bias control is moved slowly from the maximum end, oscillation usually commences at considerably less than full amplitude. Such an adjustment is not very stable, and oscillation is liable to take a jump up in strength, or else to cease entirely.

So although the low amplitude adjustment gives an exceptionally pure signal it is better to reduce the bias a little, to bring it to the point where any further reduction causes only a slight increase in amplitude. The correct adjustment is shown in Fig 4, and can be judged by ear, although a metal rectifier voltmeter or valve voltmeter shows the effect more distinctly.

Frequency Calibration

Assuming that the gear has been found to be functioning correctly, attention can be given to checking the frequencies. These are given in the following table, and, of course, the accuracy of the frequency figures depends on the correctness of the chokes and condensers. Fortunately a 10 per cent. error in either of these causes only a 5 per cent. error in frequency. Even so, most users of the apparatus will no doubt feel happier to have some check on the frequencies actually obtained. This can be done with the assistance of the common piano, which even if out of tune to the extent of a semitone is correct within 6 per cent. The least musical pianist is probably in a position to guarantee something better than that. By striking the note nearest to the pitch of the oscillator signal and comparing it with Fig. 5 the actual frequency can be found. Of course, the piano scale does not extend up to 10,000 cycles, but the correctness of its highest frequencies can be judged by octaves (which is easier said than done). The black keys

Frequency	Inductance Switch	Condenser Switch
50	1	1
75	2	1
110	1	2
180	2	2
250	1	3
400	2	3
500	1	4
800	2	4
1,000	3	3
1,500	4	3
2,000	3	4
3,000	4	4
4,500	5	4
6,600	4	5
10,000	5	5

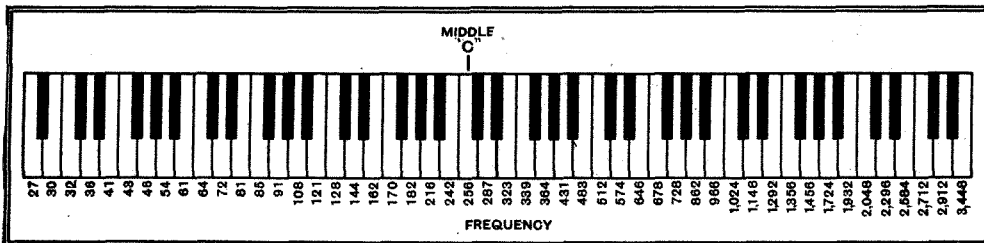

Fig. 5.—The frequencies of notes on the piano afford a convenient method of calibrating the oscillator.

one or two), but the air-core choke cannot be expected to oscillate with the larger capacities (condenser switch at one or two). Actually it is undesirable to have to work close to zero bias, and the normal working bias is several volts. If the

give a further selection of frequencies approximately midway between those of the adjacent white keys.

In another article the uses of the oscillator will be dealt with.

(To be continued.)

LIST OF PARTS

After the particular make of component used in the original model, suitable alternative products are given in some instances.

- 1 Special tapped choke, 8/20 henrys **Wearite**
- 1 Special tapped choke, 0.25/0.55/1.2 henrys **Wearite**
- 1 Fixed Condenser, 0.5 mfd. 200 volts D.C. working **T.C.C. Type 50**
- 1 Fixed Condenser, 0.1 mfd. 200 volts D.C. working **T.C.C. Type 50**
- 1 Fixed Condenser, 0.02 mfd. 200 volts D.C. working **T.C.C. Type 40**
- 1 Fixed Condenser, 0.005 mfd. 200 volts D.C. working **T.C.C. Type 40**
- 1 Fixed Condenser, 0.001 mfd. 200 volts D.C. working **T.C.C. Type 34**
- 1 Fixed Condenser, 2 mfd. 200 volts D.C. working **T.C.C. Type 50**
- 1 Fixed Condenser, 1 mfd. 200 volts D.C. working **T.C.C. Type 50**
- (Dubilier)
- 1 Resistor, 150,000 ohms, 1/4 watt **Erie**
- 1 Resistor, 10,000 ohms, 1/4 watt **Erie**
- (Dubilier)
- 1 Potentiometer, 10,000 ohms, logarithmic **Watmel**
- 1 Potentiometer, 500 ohms linear **Watmel**
- 1 Pair Output Terminals **Belling-Lee Type "M"**
- 2 5-way Single pole Switches **Wearite**
- (Ferranti)
- BATTERY MODEL ONLY.**
- 1 Fixed Condenser, 1 mfd. 200 volts D.C. working **T.C.C. Type 50**
- (Dubilier)
- 1 Resistor, 100,000 ohms, 1/4 watt **Erie**
- 1 Resistor, 200 ohms, 1/4 watt **Erie**
- (Dubilier)
- 2 4-pin Valve holders **Benjamin**
- 1 2-pole on-off Switch **Bulgin S104**
- 6 Terminals: L.T.+; L.T.-; Grid-; H.T.-; H.T.+1; H.T.+2 **Belling-Lee Type "M"**
- 1 H.T. Battery, 105 volts, tapped every 3 volts **Drydex Type H1023**
- 1 L.T. Accumulator **Mazda**
- 2 Valves: S215B; P220A **Mazda**
- A.C. MODEL ONLY.**
- 1 Mains Transformer, 4 volts and 80 volts output **Hayberd W.29**
- 1 Metal Rectifier **Westinghouse H.T.5**
- 1 Choke, 20H. 20 mA. **Wearite H.T.25**
- 2 Fixed Condensers, 4 mfd. 200 volts D.C. working **T.C.C. Type 561**
- 1 Fixed Condenser, 15 mfd. 100 volts D.C. working **T.C.C. Type 541**
- 1 Fixed Condenser, 50 mfd. 12 volts D.C. working **T.C.C. Type 501**
- 1 Fixed Condenser, 10 mfd., 50 volts D.C. working **T.C.C. Type 521**
- (Dubilier)
- 1 Resistor, 5,000 ohms, 1 watt **Erie**
- 1 Resistor, 3,400 ohms, 1/4 watt **Erie**
- 1 Resistor, 750 ohms, 1/4 watt **Benjamin**
- (Dubilier)
- 2 5-pin Valve holders **Benjamin**
- 1 Single-pole on-off Switch **Bulgin S.102**
- 2 Valves: Mazda AC/S2; Micromesh P.A.1.

The Radio Industry

FERRANTI transformers are used in the radio installations on the "surprise" trains of the Belgian State Railways. These excursion trains de luxe are so called because their itinerary is not announced before departure.

Marconiphone public address equipment was extensively used at the various ceremonies which took place during H.M. the King's visit to Lancashire this week.

A scheme whereby anti-interference service stations are to be set up in various parts of the country has been devised by British Radio-Phone, Ltd., of Aldwych House, Aldwych, London, W.C.2. In connection with this scheme a well prepared booklet dealing with the cause and suppression of electrical interference has been issued.

A new depot is to be opened next month by the Fuller Accumulator Company, Ltd., at 13, Cumberland Street, Bristol.

The Eelex Duplex Short-wave Coil has been reduced in price from 5s. to 2s. 6d. The corresponding 8-pin base now costs 1s. 6d. Makers: J. J. Eastick and Son, 118, Bunhill Row, London, E.C.1.

Catalogues Received

Charlton Higgs (Radio), Ltd., 12-14, Spenser Street, London, S.W.1.—1934-1935 Receiver and Radio-gramophones.

The High Vacuum Valve Co., Ltd., 113-117, Farringdon Road, London, E.C.1.—Hivac Valves: descriptive catalogue with technical data and curves.

Practical HINTS and TIPS

AIDS TO BETTER RECEPTION

WHEN measuring the total anode current of a "straight" receiver the indication given by the meter should be totally unaffected by the setting of the tuning condenser, except, perhaps, when strong signals are being received. If

Superhet Anode Current

current were found to vary with changes of tuning one would know that the set was in a state of self-oscillation, or, worse still, that parasitic or spurious oscillation was taking place at some frequency other than that to which the circuits were tuned.

In a superheterodyne, however, it will be found that the anode current of the oscillator valve normally varies slightly with the setting of the oscillator tuning condenser, and so a slight variation in the total anode current is to be expected in the circumstances described. The change is, however, usually so small in proportion to the total current that it will seldom be perceptible; it will, however, be observed when measuring the current of the oscillator valve alone.

WHEN non-rigid wire is used for the internal connections of a receiver the neatness, and sometimes the efficiency as well, of the finished article may be improved by securing the leads in position with the help of clips. But, unfortunately,

Improvised Wiring Clips

suitable clips do not seem to be readily available. The *Wireless World* laboratory has found that short sections, about $\frac{1}{4}$ in. wide, of rubber "draught excluder" may be used very satisfactorily for this purpose. The material is readily obtainable, and is easily cut to any required size. These improvised clips may be secured in position by means of screws, brass tacks, or even

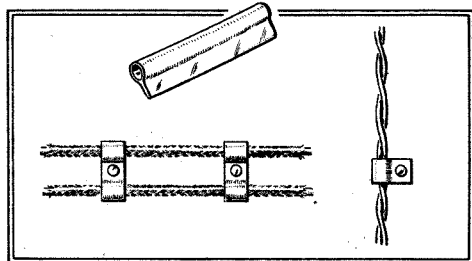

A length of rubber "draught excluder" and methods of using sections cut from it for supporting wiring.

by very small drawing-pins. Parallel lengths of twin wiring may be fixed with the help of pairs of clips held by a single pin in the manner suggested in the accompanying sketch. These rubber clips may also be used for supporting loud-speaker extensions, etc.

ALTHOUGH the connection of a gramophone pick-up to the great majority of receivers is an extremely simple matter, it is a fact that complications are likely to ensue when dealing with certain specialised sets. For example,

The Modulating Pick-up

take the case of a receiver employing drastic tone correction in the L.F. amplifier as compensation for deliberate attenuation of side-bands in the tuning system; with the ordinary form of connection the H.F. circuits are entirely inoperative for gramophone reproduction, and as the pick-up does not "cut side-

ceiver valves are in operation, and that the circuits must be tuned to the wavelength at which the oscillator is set, just as if an outside signal were being received. A very small variable condenser in series with the pick-up coil through which oscillations are transferred to the set acts as a volume control, but, to avoid risk of overloading the oscillator, it might be wise to use as well a normal type of pick-up potentiometer control. Complete screening of the oscillator unit and the connecting leads is essential.

Several interesting points emerge when using an arrangement of this nature. For instance, up to a point the A.V.C. system of the receiver will be operative in preventing overloading; but, of course, it will only tend to compensate for differences in amplitude of the oscillator output, and not for changes in modulation. The simple arrangement shown represents only one way of modulating the oscillator, but there is no reason why other methods should not be employed.

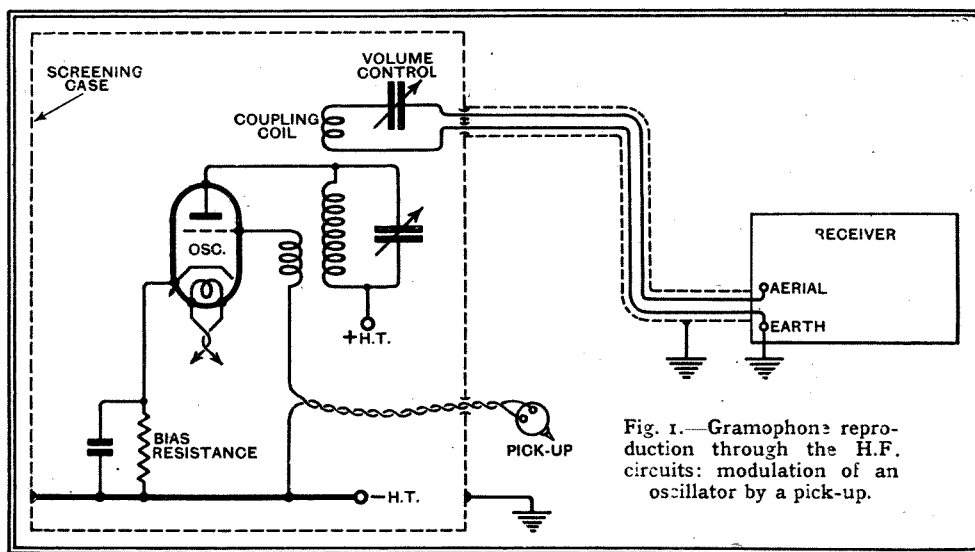

Fig. 1.—Gramophone reproduction through the H.F. circuits: modulation of an oscillator by a pick-up.

bands" it is fairly obvious that unless means are devised to alter its characteristics the existing L.F. amplifier will be entirely unsuitable for dealing with the output from a pick-up. Again, in certain receivers where the output from a diode detector or H.F. metal rectifier is applied direct to the output valve, there is normally insufficient L.F. magnification for gramophone work, and it accordingly becomes necessary to resort to the expedient of converting one of the other receiver valves, which would otherwise be idle, into an L.F. amplifier for gramophone work.

Those who use receivers of these types, and also those who are experimentally minded, may be interested in an unconventional method of making use of the output from the pick-up. Instead of feeding this output directly to the L.F. section of the receiver, it is possible to cause it to modulate a separate oscillating valve, the modulated output of which is then applied to the aerial and earth terminals of the set. A typical arrangement of this sort, which one of our readers has found to give satisfactory results, is shown in Fig. 1.

It will be clear that with this method of gramophone reproduction all the re-

IT is now generally agreed that, under modern conditions of broadcast reception, a variable selectivity control is a most valuable feature in a receiver. With the help of a really effective control it is possible during the hours of daylight, or at any other time when interference is not present, to widen the frequency response of the receiver in order to enjoy the most natural reproduction possible. On other occasions, less perfect reproduction must be tolerated, and so the control is used to restrict both high-note response and interference.

Selectivity and Tone Control

At one time it was thought that there was a world of difference between selectivity control and tone control, but now it is realised that they are essentially similar. Selectivity control may be defined as a system which regulates the frequency response of the H.F. section of the receiver, while tone control operates in the L.F. amplifier. A really effective system of tone control can therefore be used in very much the same way as a selectivity control in minimising various forms of interference from adjacent-channel stations.

At one time it was thought that there was a world of difference between selectivity control and tone control, but now it is realised that they are essentially similar. Selectivity control may be defined as a system which regulates the frequency response of the H.F. section of the receiver, while tone control operates in the L.F. amplifier. A really effective system of tone control can therefore be used in very much the same way as a selectivity control in minimising various forms of interference from adjacent-channel stations.

Single-Span Developments

The Characteristics of the System

By W. T. COCKING

THE principle of single-span tuning can briefly be summarised as a superheterodyne method of reception in which the intermediate frequency is higher than any wanted signal frequency and the oscillator frequency is higher than the intermediate frequency. Since frequencies which can cause second channel interference are higher than the frequencies to be received by twice the intermediate fre-

over frequencies from 1,750 kc/s to 3,100 kc/s, and second channel interference can only occur from signals in the 3,350 kc/s to 4,700 kc/s band. This is sufficiently far from the receiving range for there to be no difficulty in constructing a filter for its elimination.

It is well known that the ordinary superheterodyne is very prone to generate whistles when it is used near a powerful transmitter, unless a very high degree of pre-selection be used. Only a few of these whistles are due to second channel interference, and the majority are due to harmonics produced in the frequency-changer, and so cause interference when receiving stations spaced from the local by much less than twice the intermediate frequency.

It may be asked, therefore, why similar whistles do not occur with single-span tuning, for there is apparently less protection against their production than in the conventional superheterodyne. The whistles do not occur because of the smaller magnitude of the signal voltages applied to the frequency-changer.

This question is one of importance and will well repay a detailed investigation. It must be remembered that in the absence of harmonics produced in the receiver itself, there are very few possibilities of whistle-production with single-span tuning. No frequency-changer is quite perfect, however, and there is no doubt that harmonics are generated. The important point, however, is the amplitude of the legitimate frequency-changer output relative to that due to harmonic generation. Even if the latter be present, it is of no importance if

*I*N this article the general features of the single-span principle of reception are outlined and the author discusses their advantages and disposes of certain criticisms which were made against the system when it was first introduced by "The Wireless World." In a further article some possible modifications of the original principle which have been investigated will be dealt with

it be so weak that it is below audibility.

This gives the clue to the reason for the freedom from whistles in a single-span receiver, for the harmonic generation of a frequency-changer depends upon the magnitude of the signal voltages applied to it, and these are much less when the aperiodic aerial coupling system is employed. This is perhaps best illustrated by an example, and under certain fairly normal receiving conditions in London, the London Regional transmitter produces 0.2245 volt R.M.S. in the aerial.

Aerial Input

Using a tuned aerial circuit of standard type, this means an input to the first valve of 3.75 volts R.M.S., but with the aperiodic system used with single-span tuning it means an input of only 0.158 volt R.M.S. When receiving other stations the input to the first valve from the local naturally falls when using a tuned aerial circuit, for this circuit is then mis-tuned from the local, but with single-span reception the input remains unchanged. Even when the aerial circuit is mis-tuned

The Single-Span principle applied to a receiver for A.C. mains operation.

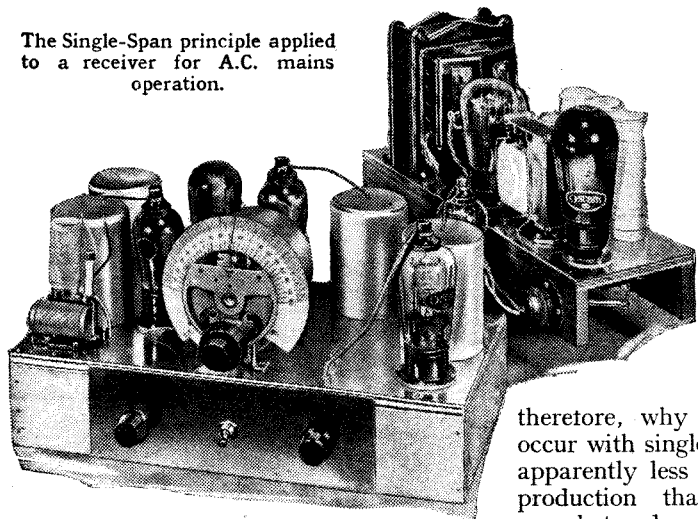

quency, it is possible to use a fixed circuit for their rejection, and no signal-frequency tuning is necessary. This makes for an extremely simple receiver, for all tuning can be carried out by means of a small variable condenser in the oscillator circuit, and the necessity for ganged controls with the consequent difficulties of adjustment is abolished.

In addition to this, however, the possible tuning range is greatly extended, and the medium and long wavebands can easily be covered without coil changing or switching. An aerial coupling system giving a sensibly even response over the required receiving range, but greatly attenuating frequencies outside that range, completely prevents second channel interference.

Up to the present, receivers including single-span tuning have employed an intermediate frequency of 1,600 kc/s, and have been built for a receiving range of 150 kc/s to 1,500 kc/s (2,000-200 metres), so that the oscillator is tunable

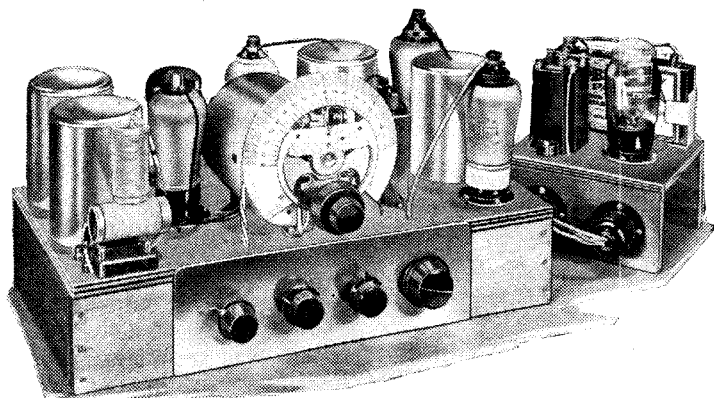

A battery version of the Single-Span receiver.

from the local by as much as 100 kc/s, however, the input to the first valve is of the order of 0.35 volt R.M.S.—over double that with single-span tuning.

Single-Span Developments—

Where signal-frequency amplification is included, conditions are much worse, and the frequency-changer input may be several volts even when the signal-frequency circuits are mis-tuned from the local by 100 kc/s or more.

Now the percentage harmonic generation depends very largely upon the input to the frequency-changer, and increases very rapidly when the input rises above a certain figure. At the input of 0.158 volt

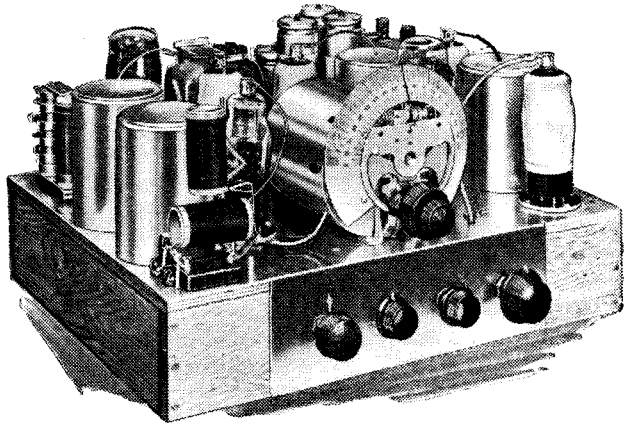

A design for operation from A.C. or D.C. mains

R.M.S. normally obtained with single-span tuning, the harmonic generation is negligible. In practice, interference has been experienced only from one or two causes. If the intermediate frequency is equal to twice the frequency of a local station, a whistle may be found on every station. Stations other than the local cause no difficulty, so that it is only necessary to select a frequency which is not a low multiple of that of the local station.

In England this rules out 1,336 kc/s, 2,004 kc/s, 1,534 kc/s, 2,301 kc/s, 1,608 kc/s, 2,412 kc/s, 1,754 kc/s, 2,631 kc/s, 1,954 kc/s, 2,931 kc/s, 2,026 kc/s, 3,039 kc/s, 2,100 kc/s, 3,150 kc/s, 2,298 kc/s, 3,447 kc/s—considering harmonics up to the third. It is evident that with a frequency of 1,600 kc/s only the second harmonic of the Scottish Regional could cause trouble. Even this possibility can be removed by choosing an intermediate frequency slightly higher in value. The ideal frequency in this respect for receivers for use in this country would appear to be some 1,680 kc/s.

Interference Problems

The second cause of interference which has been occasionally observed with single-span reception, is that a station may be tuned in at two different dial settings, one on either side of a local. It has been observed that the dial settings are those corresponding to stations spaced from the local by an amount equal to the frequency of the interfering transmissions. Thus, in the London area high-speed Morse interference has at times been found on 977 kc/s and on 777 kc/s, and has been definitely traced to a station working on about 100 kc/s (3,000 metres).

The mechanism of the interference appears to be that due to non-linearity in

the frequency-changer the interfering station beats with the local to produce sum and difference frequencies, and these are heterodyned to the intermediate frequency whenever the oscillator is tuned to certain frequencies. Thus, with the London Regional on 877 kc/s, the frequencies produced are $877+100=977$ kc/s, and $877-100=777$ kc/s, and these give audible interference when the oscillator is working on 2,577 kc/s or 2,377 kc/s for the reception of stations on 977 kc/s or 777 kc/s respectively. For this trouble to occur, it is necessary for both stations involved to be very strong, and it may be avoided by using an aerial circuit which reduces the input from either station. The interference, for instance, has never been found due to the London National transmitter, for the aerial input from this station under the conditions of test is only about one-tenth of that from the London Regional.

This particular interference is not difficult to eliminate, for the station responsible lies outside the desired receiving range, and an aerial filter giving greater attenuation of frequencies lower than 150 kc/s would effect a complete cure. In certain circumstances, however, it is conceivable that interference of this type might occur due to two stations which are both within the receiving range. Here again the remedy is easy, but different. The use of a wave-trap, tuned to either of the transmissions, in the aerial lead to the set will effectively prevent the interference, and has other advantages which are too numerous to be discussed here.

Three different single-span receivers have been described in *The Wireless World*—one for A.C. operation, one for batteries, and one for either D.C. or A.C. mains supplies. The difference between these sets, however, as far as the single-span principle is concerned, lies only in the different types of valves which were employed, and for our present purposes they can be considered as being essentially the same.

The experience gained in the design and testing of these sets has shown that the single-span principle is an eminently satisfactory one, and that the special interference possibilities which have just been discussed are unimportant and become negligible when the undoubted advantages

of the system are taken into consideration. The possibilities of whistle production in a single-span receiver are much less than in the ordinary superheterodyne, and comparative tests on the same aerial have shown that where a single-span receiver gives no whistle at any part of the tuning range, an ordinary well-designed superheterodyne gives at least ten whistles.

Correspondence with constructors of these sets has further borne out these tests, and to those accustomed to the vagaries of the usual superheterodyne, the freedom from whistle production of the single-span receiver is remarkable. It may be mentioned that although a few constructors have experienced whistles, not a single case has yet been found which has not readily yielded to simple treatment.

Background Hiss

As is inevitable when any sweeping change is introduced, adverse criticism has been directed against the single-span principle by some, principally by those who have not given it a practical test. It is said in some quarters that the system is more liable to whistle production than the ordinary superheterodyne, that it is inefficient, that it gives a high level of background hiss, and that the adjacent channel selectivity is poor. If these criticisms were true there would, of course, be no case for single-span tuning, but they contain a sufficient element of truth to call for a few words of rebuttal.

The point about whistle production has been dealt with at some length, and it has been shown that, contrary to what theorists might expect, the chances of this form of interference are not greater, but considerably less than with the ordinary superheterodyne. The charge of inefficiency, if by this is meant a lower total sensitivity for a given number of valves, contains a greater element of truth. There is undoubtedly a loss in the aperiodic aerial coupling as compared with a tuned circuit—a loss which may be as great as 10 db. The maximum stable stage gain at a frequency of 1,600 kc/s is also less than that at 110 kc/s, but taking into account all these differences, equivalent sensitivity can be secured with not more than one additional valve in the single-span system. Since the

tuning circuits are so much simpler, this does not necessarily increase the cost of the set. In any case, the need for an extra stage of amplification does not in any way offset the technical as distinct from any economic advantages of single-span tuning.

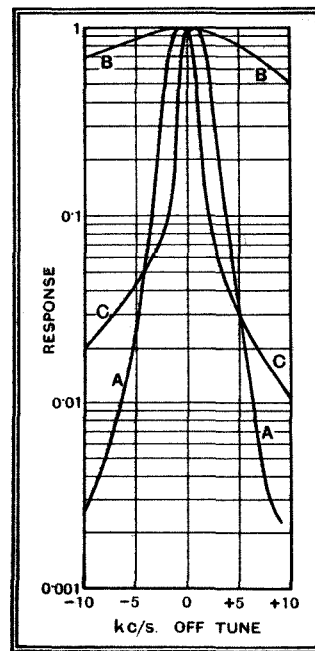

Fig. 1.—Selectivity curves of the Single-Span receivers already described in *The Wireless World* compared with the curve of a normal superhet of high selectivity.

Single-Span Developments—

The next point to be considered is that of background hiss. If the hiss originates in the frequency-changer, then it should be some 10 db. greater in a single-span set than in an ordinary superheterodyne, and some 40 db. greater than in a superheterodyne with a signal-frequency amplifier. Experience shows that the hiss does not increase to anything like this extent, and that there is very little to choose between a single-span receiver and an ordinary superheterodyne on this score. Great improvements in valve design have recently taken place, and it is believed that the frequency-changer is no longer the major source of hiss. It is well-known that the ultimate limit to usable amplification is set by thermal agitation of the electrons in the conductor forming the first circuit, and there is no increase in this effect in single-span reception.

Selectivity

It has been suggested by those who believe that the frequency-changer is the major source of hiss that signal-frequency amplification should be developed. Actually it is not difficult to design an aperiodic H.F. stage, and it might even prove simpler to design an aerial filter and intervalve coupling which together give the desired frequency characteristics than an aerial filter alone. The point which the protagonists of signal-frequency amplification overlook, however, is that the increased input to the frequency-changer would almost inevitably lead to serious whistle production.

The position, therefore, is that signal-frequency amplification is undesirable under present normal conditions, and it is unnecessary for the reduction of background hiss for the sufficient reason that this hiss is negligible in the reception of any worth-while station.

The charge of poor adjacent channel selectivity which has been levelled against single-span reception is due entirely to the high intermediate frequency employed. The selectivity obtainable from any receiver depends upon the number of tuned circuits used, their efficiency, the degree of coupling adopted, and the frequency at which they operate. Assuming that the other factors remain constant, circuits which give a certain attenuation at a frequency of 10 kc/s different from resonance, when this is at 110 kc/s, will give the same attenuation at a frequency of 145 kc/s off-tune when the intermediate frequency is increased to 1,600 kc/s. At first sight, therefore, there does appear to be a very big loss of selectivity.

The other factors, however, must be taken into consideration. The coils used at 110 kc/s have usually only a low ratio of reactance to resistance (magnification), and they are coupled tightly to prevent excessive sideband cutting. It is not difficult to build more efficient coils at 1,600 kc/s, and they can be loosely coupled without the high note response being greatly reduced. On the other hand, more tuned circuits are included in the

average superheterodyne than in the single-span receivers which have so far been described. By the application of reaction, however, it is possible greatly to increase the magnification of one tuned circuit, and so the selectivity of the complete receiver.

The net result is that although the adjacent channel selectivity is below that of many superheterodynes of conventional design, it is quite high enough for normal purposes. This is well brought out by the curves of Fig. 1. Curve A shows the selectivity of an unusually good superheterodyne embodying eight tuned circuits—two at signal-frequency and six at the intermediate frequency. The signal-frequency at which this curve was taken was 200 kc/s, so that the selectivity is somewhat higher than on the medium waveband. Curve B shows the selectivity of the single-span receiver with the reaction control set at minimum, and represents the case of four tuned circuits only resonating at 1,600 kc/s. The selectivity is very much less than that shown by curve A, and is, of course, unsatisfactory

for anything but local reception. The application of reaction, however, enormously increases the selectivity, as shown by curve C for a particular setting of the reaction condenser.

A careful examination of these curves shows that with reaction the selectivity of the single-span receiver is adequate for the separation of adjacent channels when the stations are of similar strength, and that the lower selectivity of the single-span receiver will be most noticeable in the increased spread of a local transmitter. Practical experience exactly bears out this conclusion, and this characteristic of the receiver was thoroughly dealt with in earlier articles.

It will thus be seen that a careful examination of the criticisms which have been directed against the single-span principle reveals only one point in which the receivers so far described may be inferior to normal superheterodynes, and this is in selectivity. Even here, however, the curves of Fig. 1 show that the selectivity is adequate for good distant reception.

[To be concluded.]

Letters to the Editor

The Editor does not hold himself responsible for the opinions of his correspondents

“What is a Radio Engineer?”

AS the term “engineer” appears to be much misused, particularly in the radio profession, may I, through your columns, endeavour to define the accepted meaning of the word?

Engineers are so called when they are qualified to act in a consulting or technical capacity in any particular field of engineering.

Now, the radio profession covers too vast a field for a person to be a specialist in all branches. Therefore, our engineers of today specialise.

Now, a radio service engineer, to be so called, should be thoroughly conversant with the general principles underlying modern receiver design, and be thoroughly acquainted with testing methods necessary to locate faults in modern commercial receivers.

The Institute of Electrical Engineers is, as your correspondent points out, a representative body of the electrical profession, and the fact that one has been admitted as a member of the Institute does set a seal upon his qualifications to act in a technical capacity in the particular field of the industry in which he specialises. A. G. FARNLEY.
Portsmouth.

Transients

YOUR correspondent Mr. M. J. McBride (whose letter was published in the issue of June 1st) seems to be “barking up the wrong tree” himself in his eagerness to accuse Mr. Robin of “going off the rails.”

My dictionary gives the Latin derivation and current meaning of transient as “trans, across and ire, go: passing across a space or interval and then disappearing—hence, of short duration, momentary, fleeting.” There is no suggestion of “dying away.” A transient sound is, as Mr. McBride says,

for all practical purposes non-existent after a very brief interval of time.

Considering a transient sound of percussion—a hammer striking an anvil: now, according to Mr. McBride, the wave-form of such a sound cannot be represented by a Fourier Series because it “never completely dies away”—even though it “can be assumed to be non-existent.” But suppose the sound of the hammer striking the anvil were repeated one thousand times per second; a musical note of 1,000 ~ pitch, but possessing its own tone colour, would be heard. Such a sound, being periodic, could therefore be analysed by a Fourier Series and hence one cycle of it—the original single hammer stroke—could also be represented by such a series. Graphically, the single stroke would be represented by the same series plotted for one cycle of the fundamental (1,000 ~) in the compound sound.

Similarly, a single cycle of a sound of purely sinusoidal form would be heard as a click and be termed a “transient”—but a receiver could be designed to amplify it with negligible distortion, because it consists of only one frequency instead of an infinite series.

With reference to Mr. F. J. A. Pound's letter published in the same issue; *either* of the wave forms shown would “sound like a hum” because they are cyclic or periodic and continued for several cycles: but a single cycle—or better still a half-cycle—of either the square or triangular form, being of brief duration, would be considered and heard as a transient sound. Also, the two forms would doubtless sound the same to the human ear either as continuous “hums” or as transients *when heard in the original*: but when passed through an amplifier and loud speaker they would sound differently as transients (single half-cycles), though still

the same when continuous. The reason for this would not be due to phase-shift, but to a defect in the reproducing speaker.

A year or two ago a relevant article entitled "Transients alias 'Attack'" was published in *The Wireless World*, and as far as I remember it was shown that the failure of a receiver to reproduce transients with realism was principally due to a loud speaker defect, i.e., a loud speaker will not reproduce one separate cycle "naturally" and hence fails to achieve life-like reproduction of the beginning of a sudden—though sustained—note, so that the "attack" is lost. This is because the first, or first few, cycles are attenuated until the diaphragm "gets into its stride" (an inertia effect with consequent electrical and magnetic reactions.)

Thus, in the case of two transients having identical component sine functions—but of different phase relationships (such as those mentioned by Mr. Pound)—the different noises they would make when reproduced would not be due to phase-shift, but to different amplitude distortion of the several components. This must be so because the amplitude distortion (attenuation) in the speaker is itself a transient effect, and its magnitude depends upon the interval of time since the beginning of the sound.

Hence I conclude that

(a) the sole requirements of a receiver to reproduce transients are (i) a uniform overall frequency response covering the audible range of frequencies, and (ii) a speaker free from inertia.

(b) Phase-shift does not cause faulty reproduction of transients because of any phase consciousness of the ear, but because of the different transient amplitude distortion of the components which will ensue in the speaker if phase-shift has occurred in the receiver.

L. E. FARRELL,
Sgt., Royal Air Force.

Peshawar, India.

Loud Speaker Performance

SINCE the majority of modern loud speakers have no appreciable output below 100 cycles or higher, and are, moreover, used in baffles totally inadequate for efficient radiation at these frequencies, it seems to me that a high-pass filter in the earlier part of the L.F. amplifier would be advantageous for the following reasons:—

(a) If the speaker and baffle is cut off at a certain frequency, notes below that are valueless, and their omission cannot destroy quality.

(b) Most speakers give very bad amplitude distortion and modulation effects when fed with frequencies below their cut-off of high intensity, and hence omission of these frequencies actually would increase quality.

(c) Overloading in the output stage would be diminished under usual conditions of operation.

The actual frequency of the cut-off would be determined by the type of speaker and size of baffle available. Certainly, anyone who has seen a real 50-cycle speaker at work and noticed the huge motion of the cone, will realise how fatuous it is to feed these low notes to the ordinary small M.C. speaker. It may sound paradoxical to increase quality by restricting the frequency response of the amplifier, but it is to be remembered that the ear is much more intolerant of amplitude than it is of frequency distortion, and in this case the latter is there whether we like it or not.

Abadan, Persia. P. S. VERITY.

G.E.C. Receivers for 1934-5

Six Types Covering Every Requirement

INSTEAD of waiting until the actual date of the exhibition at Olympia, the General Electric Co., Ltd., have wisely decided to release their new season's receivers during the summer months, as it is felt that interest in wireless reception now has an all-the-year-round appeal and that improvements in design have already justified the introduction of new models.

Broadly speaking, the new season's programme comprises six models, which cover the requirements of every class of broadcast listener. Undoubtedly, the principal receiver is the "A.V.C.5," which is a superheterodyne incorporating five valves (including the rectifier), designed to work from A.C. mains. It is interesting to note that, although designed exclusively for A.C. mains operation, the valves are of the universal type, with 13 v. 0.3 amp. filament,

scale has been adopted, and the graduations are arranged to give the tuning positions of all the principal European stations.

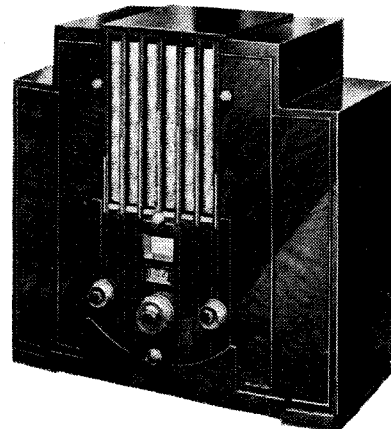

Universal A.C./D.C. Mains Three.

A set which is likely to have a wide appeal is the "A.C./D.C. Mains Three." It is a straightforward detector-L.F. receiver with a power output of approximately 2 watts to the energised moving-coil loud speaker. A low-impedance type of rectifier is used, and the voltage is controlled by a barretter. The set is housed in a handsome moulded bakelite cabinet, and the price is £7 15s.

For the battery user a similar type of circuit, with an additional L.F. stage, has been introduced in the "Battery Compact Three." This set, which includes a permanent magnet moving-coil loud speaker, sells for £5 17s. 6d. complete with batteries. The "Battery C.B.4" is a more ambitious set with a variable-mu H.F. amplifier, pentode detector, and a triode driver valve feeding a Class "B" output stage. The price of this receiver, complete with batteries, is £9 17s. 6d.

The range is completed by the new "Overseas 7," a superheterodyne receiver built to a tropical specification and housed in a bakelite cabinet. The wave-range covered is from 12 to 555 metres, with internal switching. Automatic volume control is included, and the price is £24.

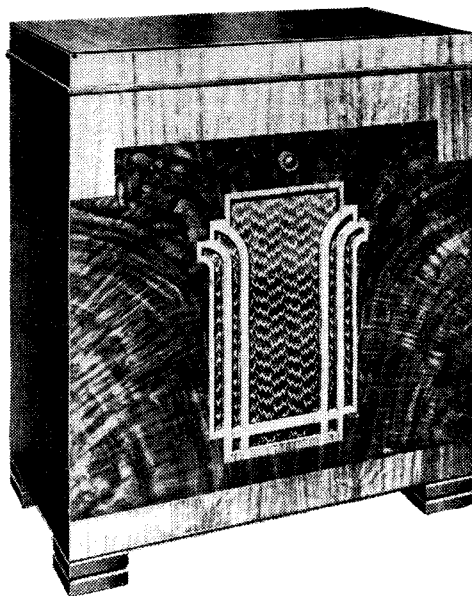

G.E.C. radiogram superhet A.V.C.5.

which are run in parallel. A heptode frequency-changer is employed, and the variable-mu I.F. stage is followed by a double diode triode, which is arranged to give delayed and amplified A.V.C. A pentode is used in the output stage, and the loud speaker is of new design with a larger diaphragm than was used in last year's models. A sensitivity control is also fitted, by means of which the range of the receiver may be reduced by a fixed amount. Owing to the action of the automatic volume control the volume of the principal stations is not affected, but background noise between these stations is eliminated.

The set is sold as a table model at 14 guineas, as a console, with horizontal control panel, at 17 guineas, and as a radio-gramophone at 22 guineas.

For those who are dependent on D.C. mains for their power supply there is the "Superhet. D.C.5" at 13 guineas. The volume control in this set is entirely manual, but in other respects its specification is similar to that of the A.C. model. Special care has been taken to ensure freedom from mains noise, and the filament voltage is held constant by a barretter lamp. A horizontal

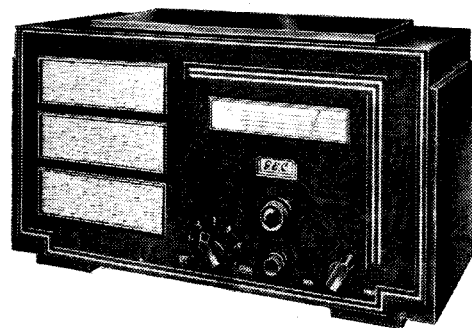

The new "Overseas" which is now housed in a bakelite cabinet and provided with internal waverange switching.

In addition to the new receivers, the new season's programme includes two loud speakers of new design, a gramophone motor and record changer, and a conversion unit for running existing D.C. sets from A.C. mains.

Bandit Tracking from the Air



Pilot and police observer take a swift survey of the map before setting out in pursuit.

ONE of the most telling points favouring the use of aeroplanes for chasing car bandits is the fact that the bandits are unaware that the 'plane is engaged in the pursuit. All their attention must of necessity be focused on the road.

Yet even if the fugitives are aware of the 'plane's function, as was the case in the very effective demonstration by the Marconi Co. at Leicester last week, it is next to impossible to evade the eagle eye and the wireless-directed patrol cars.

In the demonstration, which took place on Thursday, July 12th, the aerodrome at Desford, near Leicester, was regarded as "police headquarters," and it was here that the wireless-equipped 'plane waited until the "news" arrived that bank robbers had decamped from Banbury, travelling northwards in a car with a white roof.

Hot Pursuit

Without delay the police 'plane took to the air, and observers at the aerodrome were then able to listen on loud speakers, operated by a ground receiving station, to the short-wave messages exchanged between the 'plane and a wireless-equipped police car then on patrol. Before long the wanted car was recognised, and thereafter, for an exciting twenty-five minutes, it was pursued by 'plane and police car on its tortuous course along the Lutterworth road and the lanes leading to Peatling Parva. Aided

by messages from the 'plane, the police car was able to head off the bandits till receiving final instructions from the 'plane to pull up and wait at a strategic corner. In a few moments the hunt was over, the bandit car almost running into the arms of the police.

Although visibility was not good, never exceeding three miles, the pilot of the 'plane said that there was never any difficulty in keeping watch on the bandit car when once it had been located.

The fact that the car had a white roof helped in the pursuit, but in a subsequent interview the Chief Constable of Leicestershire (Captain C. E. Lynch-Blosse) said that in actual practice no outstanding peculiarity in the car was necessary. The

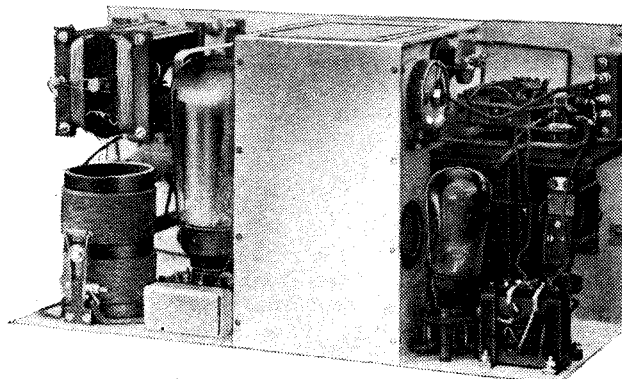

Chassis of the mobile transmitter for fitting in police patrol cars.

demonstration car had been specially marked to avoid any possibility of failure during the demonstration. In most cases

'Plane and Car Wireless Link

HOW wireless-equipped police 'planes and patrol cars can co-operate in the pursuit of car robbers was effectively demonstrated by the Marconi Company at Leicester last week. The Chief Constable of the County took part in the experiment.

it is, however, not difficult to recognise a fugitive car by the erratic manner in which it is driven, particularly at cross-roads and other danger points where the average driver would exert care. When once the car has been identified from a height of, say, 500 feet, the 'plane can ascend while still keeping its quarry in view. While open country favours the 'plane pursuit, the fugitives run grave risks in approaching a town.

Atmospherics were rather troublesome, particularly to the observers at the aerodrome following the pursuit from the loud speaker messages. Both in the 'plane and police car, however, reception was easy, and at no time did they lose touch with each other.

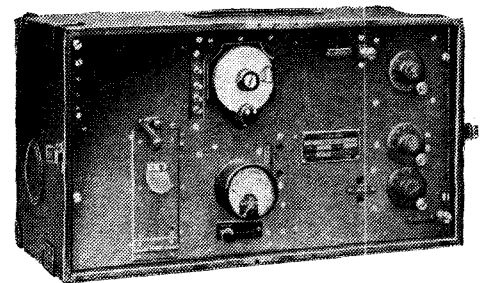

External view of the transmitter shown below. It measures only 9in. x 12in. x 8½in.

The aeroplane radio equipment was of the Marconi A.D.43/44 type, the transmitter being rated up to approximately 20 watts to the anode of the magnifier valve. Two-way telegraphy and telephony are employed. This type is commonly used for military purposes.

A wavelength of approximately 145 metres was employed during the demonstration.

THE APPARATUS DESCRIBED

PERHAPS the most interesting items of apparatus made for police use by Marconi's Wireless Telegraph Company are the transmitting and receiving sets for patrol cars. The purpose of these sets is to allow communication by either telegraphy or telephony with headquarters, or with other cars similarly equipped.

Bandit Tracking from the Air—

The complete outfit comprises receiver and transmitter units, two rotary converters, key and microphone, and a 12-volt battery. Generally speaking, the

position the aerial is sufficiently rigid for operation at high speed. The alternative of a roof aerial may be considered, but one imagines that this has not been found so effective.

vided for the filaments, and voltage is stepped up by a rotary converter for the anodes. Total consumption from the battery is stated to amount to 3 amperes.

In order that the receiver may be operated satisfactorily while the car is in motion, all the usual precautions are taken against the radiation of interference from the electrical equipment of the vehicle.

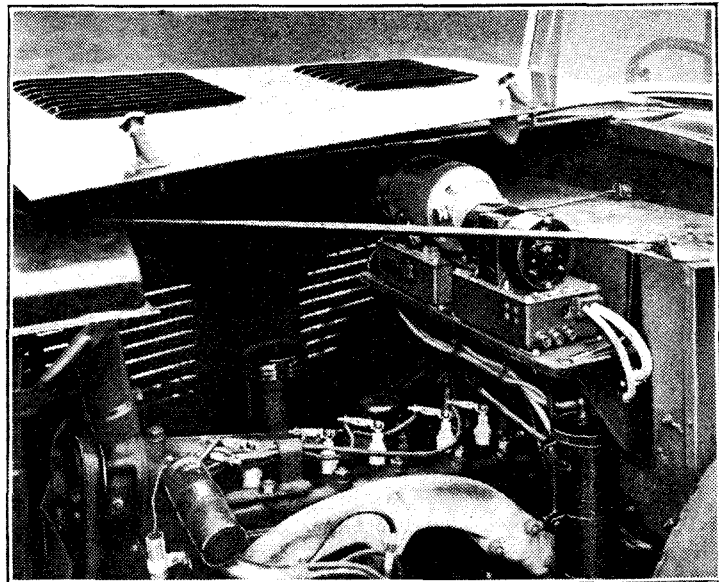

(Left) The two rotary generators for supplying anode current to transmitter and receiver are shown mounted under the bonnet of the car.

(Below) Receiver, transmitter and control unit are neatly installed under the dash. A hard microphone, connected to the control panel, is seen on the driver's seat.

transmitter and receiver are mounted below the dash, while the converters are housed under the bonnet of the car, together with their smoothing equipment and send-receive relays.

A special feature of the equipment is the provision for rapid interchange of units in the event of breakdown. With this object in view, interconnections are made wherever possible by means of plugs and sockets, and the receiver is supported on quick-release brackets; a similar form of mounting is provided for the transmitter unit.

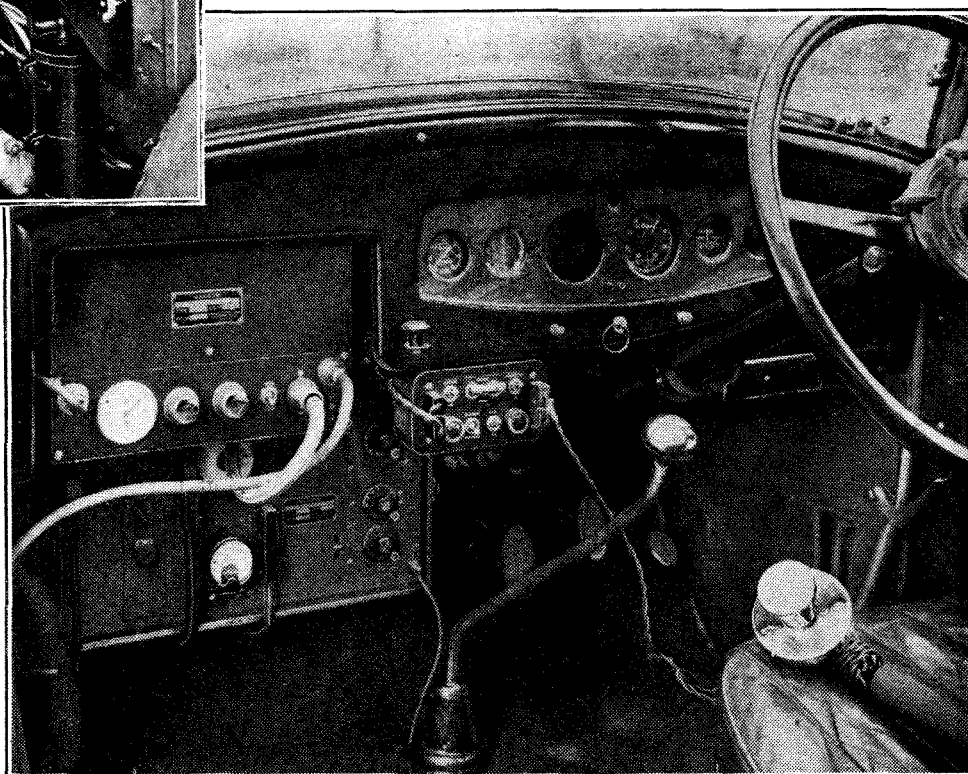

Apparatus for Headquarters

In addition to this mobile equipment special transmitters and receivers for police headquarters have been designed. The larger transmitter, which delivers 650 watts to the aerial on C.W. telegraphy, is operated direct from an A.C. mains supply, without the intermediary of rotary

Telescopic Vertical Aerial

The nerve centre of the installation is a switch unit on the dash, which embodies a send-receive switch, change-over switch for continuous wave or interrupted continuous-wave telegraphy, and also sockets for key and microphone.

It is interesting to compare the aerial with the type normally fitted in a pleasure car. In the Marconi police installation a 5ft. telescopic rod is employed, which ex-

In the transmitter unit a D.E.T.5 drive valve is followed by two of the same type in a magnifying stage. The power supply to the magnifier anodes amounts to 50 watts, and the normal operating wavelength is between 100 and 150 metres.

Filaments are fed in series from a 12-volt battery, and, of course, the anodes receive their current supply from the same battery through one of the converters already mentioned.

The receiver is in essentials similar to pleasure-car sets, but is more robust, and, apart from the difference of wavelength, embodies features not found in broadcasting apparatus. There are a total of six valves of the battery Catkin type, and, with the help of a separate oscillator valve, C.W. telegraphy can be received in addition to telephony or modulated telegraphy. Automatic volume control is fitted, and the output valve delivers 500 milliwatts to the loud speaker.

The receiver may be either remotely or directly controlled, and may be fed either from the car battery or from the special transmitter battery; direct supply is pro-

converters, batteries, etc. The frequency is crystal-controlled, and morse keying is carried out on the "auto-absorber" method, which operates in the grid circuits, and offers the advantage of avoiding wide fluctuations in load between the transmission of the characters of the morse code. For telephony purposes the transmitter is modulated by the D.C. grid method; the same applies to I.C.W., the tone generator for which supplies three different frequencies at will.

A smaller transmitter for police headquarters delivers 150 watts to the aerial, and is basically similar to the larger set.

It is interesting to compare the headquarters receiver used in conjunction with these transmitters with standard broadcast sets. There are many points of similarity; for instance, the circuit embodies a signal-frequency H.F. stage, combined detector-oscillator, and an I.F. stage operating at 150 k/cs. The second detector is a double diode triode, which also supplies A.V.C. voltages. A detail not found in broadcast receivers is the provision of a separate oscillator for C.W. reception.

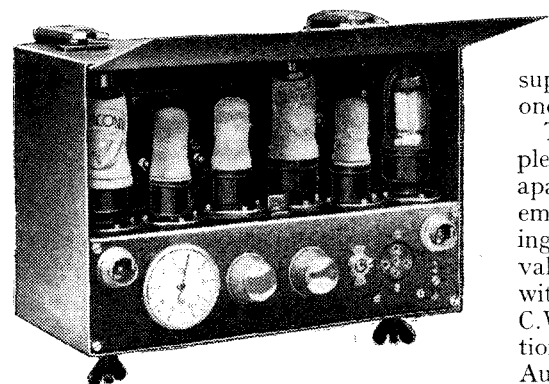

The mobile superheterodyne receiver, with protective front cover raised.

tends to 9ft. ; in the latter position it is used only when the car is stationary, and when maximum range is required. In the closed

News of the Week

Current Events in Brief Review

Teachers Taught

THE University of Michigan is inaugurating a course to teach teachers to teach by radio. More than a hundred students have been enrolled to learn this special technique of broadcasting.

Super Tax

CERTAIN French listeners pay "super tax" not because their incomes exceed a certain level but because they let July 1st pass without having paid the necessary fee. An additional sum is automatically levied on each listener in lieu of police court fines.

Paris Relays B.B.C.

RADIO PARIS will relay the B.B.C. programme in commemoration of the "birthday" of Canada to be broadcast on July 24th. French listeners are especially interested in the episodes concerned with Jacques Cartier, who landed at Quebec in 1534 and began the task of colonisation.

Broadcast Competition

THE opinion that New Zealand had been unwise in removing the competitive element from the broadcasting sphere, was expressed last month by Mr. M. V. Duffy, president of the Federation of Commercial Broadcasting Stations of Australia. Mr. Duffy said the dual system had led to a vast improvement in Australia, where Government and privately owned stations are permitted to exist side by side.

Misunderstood

CONSTERNATION among the shipping of the South Seas was caused by the recent broadcasting of a gramophone record by 3YA, Christchurch, New Zealand. It was "Rocked in the Cradle of the Deep," sung by Malcolm McEachern, and the background effects included SOS, SOS, SOS, in Morse. An operator of a New Zealand commercial station happened to be listening, and as the SOS was very faint he did not connect it with the record. He called all New Zealand and Australian shipping to clear the air for a quarter of an hour and anxious searching of the ether went on for several hours. The record will not be broadcast again in New Zealand!

Three-Month Radio Show

THE Department of Overseas Trade informs us that the Austrian Broadcasting Company (Ravag) is organising a wireless exhibition which will run for three months in Vienna, opening on October 1st next. Historical equipment, as well as the most modern apparatus, will be displayed. All desirous of exhibiting any such equipment should apply for particulars to the management of the "Oesterreichische Radio Verkehrs A.G.," 4, Johannesgasse, Vienna 1.

Compulsory Wireless Lessons

COMPULSORY wireless classes for all who have not attained the age of fifteen are to be established in the Turkish villages. At Tiflis, in the Caucasus, an official receiver is at the disposal of every school in the town.

Sweet are the Uses . . .

OUR Swiss contemporary *Radio* of Lausanne, inveighing against radio advertising, publishes an amusing anecdote illustrative of its dangers.

The other day an announcer had made reference to important discussions at Geneva between French and British politicians. Immediately afterwards the same an-

Paris Police Wireless

THE Paris police are increasing their use of wireless. All the central police stations are about to be equipped with transmitters and receivers.

Regular Programmes from the Antarctic

THE regular Saturday transmissions from the Byrd Antarctic Expedition are well worth the attention of all short-wave listeners. These messages, which are relayed over the Columbia Broadcasting System, usually originate at Little America, the base camp, though in some cases Commander Byrd himself can be heard from his outpost some fifty miles nearer the South Pole. Transmis-

Vatican Radio Director's Death

FATHER GIUSEPPE GIANFRANCESCHI, well known as the director and announcer of the Vatican short-wave wireless station, died at Rome on July 9th. Father Gianfranceschi was a technician and scientist of repute.

No New Radio Firms

NO new firms manufacturing radio articles may now be established in Germany, according to a decree of the Minister of Economy, and the regulation remains in force until December 31st, 1936.

This stringent measure is stated to be necessary to safeguard the radio industry from unwanted competition.

Anti-Interference War

THE war against man-made static is now being carried to Roumania, where owners of electrical apparatus have been ordered to fit anti-interference devices within a prescribed time.

A list of statutory penalties for non-compliance with the order has just been published.

More Licences

BRITISH wireless licences in force on June 30th numbered 6,373,600, compared with 5,597,200 a year ago. The net increase for the month was 34,000.

It seems unlikely that the 7-million mark will be reached this year, but the figures give reasonable hope that the seven-millionth licence may be sold before the Wireless Show of 1935. There is no sign of the "saturation point" being approached.

Power-by-Radio Mystery

DEEP secrecy surrounds experiments in power transmission by radio on the Sante Fé railroad, according to our Washington correspondent. It is claimed that two motor trolleys travelled several miles in March last under power drawn from the ether. Since then it has been learnt that a company calling itself the Wireless Power Transmission Corporation, with headquarters at Providence, R.I., has been formed to construct a 1,000-kilowatt power-by-radio transmitting station.

Mr. John C. Roberts, President of the company, stated: "A 1,000-kilowatt transmitting station will enable me to transmit power to trains by wireless without the necessity of engines or fuel, over a radius of 100 to 150 miles."

Radio engineers, however, are inclined to give the story little credence, although the power-by-radio idea has long been toyed with. There is no proof that the Santa Fé experiment actually took place, nor is there any record that the Federal Radio Commission granted the necessary wavelengths.



WEEKLY BROADCASTS FROM THE ANTARCTIC. Until further notice the Columbia Broadcasting System of America is relaying messages from the Byrd Antarctic Expedition every Saturday on short waves as well as over its American network. This photograph, showing Admiral Byrd at the microphone, was taken at the base camp at Little America.

nouncer said in the same voice: "Wash your dirty linen with the X washing machine."

Television to Australia?

THE possibility of low-definition television transmissions from England to Australia was put forward by Mr. H. M. Dowsett, of the British Marconi Company, in a recent lecture in Sydney before the Institution of Radio Engineers. Mr. Dowsett referred to successful tests between England and Australia on 25 metres, and, with these in view, emphasised that when a complete scheme for the provision of television in Australia was drafted it should include provision for long distance transmissions.

sions can be heard from W2XE, New York (15,270 kilocycles) and W3XAU, Philadelphia (9,590 kilocycles) between 3 and 3.30 a.m. (B.S.T.) on Sundays. A new feature is the exchange of messages between the Byrd Expedition and Kotzebue, Alaska.

In the Holy Land

THREE languages — English, Hebrew and Arabic — will be used at the broadcasting station shortly to be erected in Palestine. The authorities aim at a service area bringing strong reception to low-powered sets all over the country.

BROADCAST BREVITIES

By Our Special Correspondent

Droitwich Does Well

DROITWICH is already using its full power of 150 kilowatts for the unmodulated test signals after midnight. Already the engineers are highly satisfied and have expressed the opinion that the over-all frequency response will be sensibly straight up to 7,000 cycles per second.

Time-table of Tests

The schedule of tests has now been arranged and the first modulated transmissions will go out very soon. I understand that throughout August fully modulated signals will be broadcast every night between 00.00 and 03.00.

A small portion of the Daventry programme, possibly the late dance music, will be transferred to the Droitwich aerial on or about September 1st. Probably the entire change-over will be effected in a week.

The New Empire Station

Meanwhile the Daventry site, which will shortly be utilised solely for the Empire service, is fast assuming the appearance of a common or garden Regional station. One self-supporting 500-ft. mast of the Brookmans Park lattice type is already *in situ* and its companion is being erected. One wonders how the engineers will overcome screening problems, but no doubt the design of the new high-power Empire station has been very carefully thought out.

Sir John Reith's Visit to South Africa

THE fact that Sir John Reith has been invited to go to South Africa later in the year to advise on broadcasting, should occasion no surprise. The present Governor-General, the Earl of Clarendon, was, of course, formerly chairman of the B.B.C. Board of Governors and had the highest opinion of Sir John Reith's abilities.

Three Months' Absence

The Director-General of the B.B.C. will be absent from London for nearly three months, the longest period of leave that he has taken since he launched British Broadcasting from a little office in Kingsway nearly twelve years ago.

Sir John is now making a close study of the broadcasting situation in the Union, and by the time he reaches Cape Town will know as much about it as if he had been familiar with its workings for years past.

The "Proms"

ALL forty-nine Promenade Concerts are to be broadcast from the Queen's Hall this year, as usual. The National and Regional wavelengths will, roughly speaking, transmit alternate concerts.

The coming season marks the fortieth consecutive year of "Proms.," and Sir Henry Wood has performed the really remarkable feat of conducting ever since the concerts started. The first concert of the new season is on August 11th, and will be broadcast on the National wavelength.

STUDIO ACOUSTICS.

Budapest has installed new studios in which special attention has been given to acoustic problems. Besides testing with measuring instruments the engineers obtained the assistance of artists, seen in the picture, in order to gauge the effect of various wall coverings.

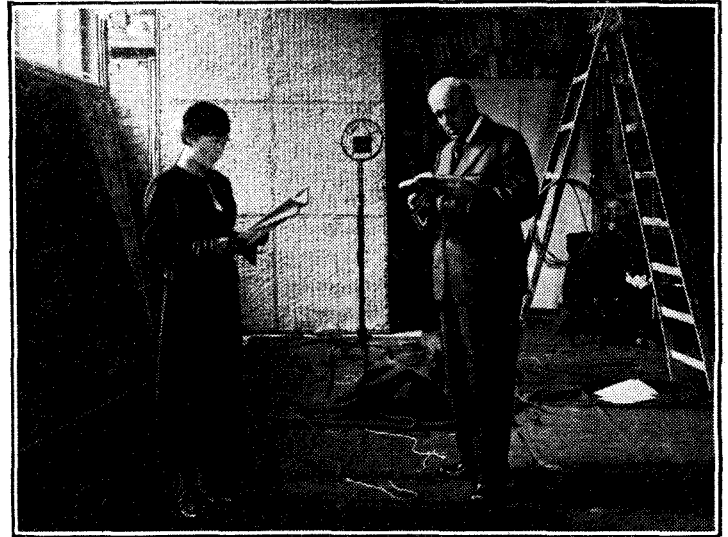

Leonard Henry on the Pier

LEONARD HENRY broadcasting from the Pier Pavilion, Worthing, suggests an overflow of holiday spirits. This is the treat promised National listeners on July 28th, when his show is to be relayed.

The programme is called "Radio Mirror," and is produced by Jack Allen. Other stars in the programme are Beryl Orde, Patrick Colbert, Joan Coleridge, and Raie da Costa. The company will be supported by the Worthing Municipal Orchestra.

Canada's Fourth Centenary

THE 400th birthday of Canada will be celebrated by a special programme on the National wavelengths on Tuesday next, July 24th. It will take the form of dramatic episodes such as Jacques Cartier's landing in Canada in 1534; the grant of the Charter to the Hudson Bay Company by Charles II, the capturing of Quebec, the completion of the Canadian Pacific Railway, and so on down to the development of Canada since the War.

Contemporary Music

Artistes taking part include Raymond Massey (narrator), Lena Ashwell, who will give a poetry reading, and Florence McHugh, the Canadian actress.

The music will be contemporary, suitable to each episode, and the cast will be largely Canadian.

Heavyweight in the Studio

FROM prize-ring to broadcasting studio marks another step in the career of the Irish boxer Jack Doyle, who appears in "International Café," an Eddie Pola feature for London Regional listeners, July 25th.

Representatives of various countries to take part, besides Doyle (Ireland), are The Three Admirals (America), John Hendrik (Germany), Lucienna Herval (France), Leon Hochloff (Russia), Satne and Armine Meduria (Spain), Rudolfo Mele (Italy), and Lola Shari (Hungary), with that lively and versatile Lancashire lass, Elsie Sterndale. Geraldo and his Tango Orchestra will be in support.

Quite a dazzling "bill."

A New Broadcast Dance Band

ONE of the lesser known dance bands, about which more is going to be heard, is that of Dare Lea, which is at present fulfilling a contract at a restaurant in Regent Street.

There is a strong possibility that Dare Lea may transfer his band to another well-known restaurant in Piccadilly and may also be heard this summer at the magnificent new swimming pool at Wembley.

The B.B.C. "O.B." department is now, in fact, already investigating the acoustics of both these places with an eye to broadcasts by Dare Lea.

The "Public School" Touch

This young man, who is 29 years of age, has enjoyed the enviable financial opportunity of being able to indulge his ambition to own a dance band. The present combination was organised by him in September last year and rehearsed solidly until April, when he obtained his first engagement.

Dare Lea is a public school boy and his announcements may bring a new atmosphere to the dance studio. Apart from the prospective engagement of Dare Lea, no other big changes in dance band plans are contemplated this autumn.

Coming Radio Drama

THE dearth of original radio dramas becomes obvious when one studies the autumn list of radio plays. In nearly every instance the play is adapted from classical fiction or from stage successes.

"Wild Decembers," Clemence Dane's story about the Brontë family, is in the Regional programme for August 7th, and the National on August 8th. A radio adaptation of "Wuthering Heights" by Emily Brontë, and that old melodrama "Maria Martin, or the Murder at the Red Barn," follow soon after. We are also promised "Old Bannerman" by Eden Phillpotts, "Nelson" by Jean Bartlett, and "Ivanoff" by Tchekov.

Charles Dickens' "Oliver Twist" will be given in December, as well as "The Great Adventure" by Arnold Bennett.

Autumn Shakespeare plays are "Measure for Measure," "Hamlet" and "Cymbeline."

The Art of Ganging

VII.—The Shaped Plate Condenser and the I.F. Circuits

THE practice is now common to employ a special gang condenser for superheterodynes so that ganging can be achieved on the medium waveband without a padding condenser. The necessary adjustments for this system are dealt with in this article together with the trimming of the intermediate frequency circuits

IN the preceding articles dealing with the ganging of a superheterodyne, no mention has been made of the adjustments necessary to the I.F. circuits, and these must normally be carried out before the ganging. It might be thought, therefore, that the I.F. adjustments should first be described, and then the ganging. In practice, however, the I.F. circuits cannot be adjusted until a signal is obtained, and it may often happen that this is impossible until the ganging is at least roughly adjusted. The general procedure, therefore, is to adjust the ganging roughly so that a signal can be obtained, then to adjust the I.F. circuits, and finally to attend to the ganging. The order in which the adjustments are carried out may thus vary somewhat according to circumstances.

Before proceeding with a description of the I.F. circuits, therefore, it may be as well to complete the description of the ganging adjustments by dealing with the

only arrangement which can theoretically provide perfect ganging.

The circuit arrangement is shown in Fig. 1, and when the switches are closed for the medium waveband, the arrangement of the oscillator tuned circuit appears no different from that of one of the signal frequency circuits. Actually, of course, the oscillator inductance has a lower value, and it is usually 126.5 mH. when the signal-frequency coils have inductances of 157 mH. The exact figure, however, varies according to the design of the condenser, so that in choosing components care should be taken to select a condenser which is designed to work with the coils which are to be used. The sections of the gang condenser devoted to the signal frequency circuits are quite normal, but the oscillator section has the vanes cut in a different manner, so that its capacity at all settings is lower than that of the signal-frequency sections. If the minimum capacities of all the circuits, therefore, have the correct values assigned to them, correct ganging is automatically secured.

Adjusting the Ganging

The process of ganging thus resolves itself into adjusting the trimmers to give the correct minimum capacities. The actual adjustments, however, are very similar to those for the padding circuit, but are somewhat easier to carry out. A low wavelength station must be tuned in with the oscillator trimmer set about one-half its capacity, and each of the pre-selector trimmers adjusted for maximum response. As before, if this leads to one or more being fully screwed home or fully unscrewed, the oscillator trimmer must be appropriately altered and the station re-tuned at a different dial setting. When a definite optimum setting has been secured for each trimmer, a station on a wavelength around 500 metres should be tuned in, and the oscillator trimmer adjusted.

This is done with one hand while the other alters the setting of the tuning dial appropriately to maintain the station in tune. As the trimmer capacity is increased, so should the dial be reduced, and vice versa. When the optimum combination of settings has thus been determined, a return should be made to the low wavelength station, and the signal-frequency trimmers re-adjusted. Go back to the long wavelength station, and re-

adjust the oscillator trimmer, then return to a low wavelength, and re-adjust the signal-frequency trimmers. This process must be carried out until no further adjustment at either wavelength leads to any improvement, and this will usually occur after about the third time. This completes the medium wave ganging adjustments, and the long waveband comes next. Here nothing must be touched but the padding condenser C of Fig. 1.

A station at the upper end of the long waveband, such as Huizen, Radio-Paris,

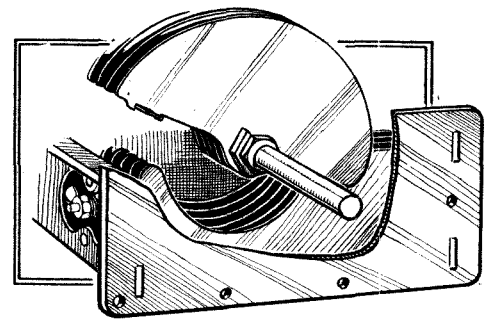

This drawing illustrates the manner in which the fixed plates of the oscillator section of a shaped-plate condenser are cut away.

or Daventry should be tuned in, and C adjusted while keeping the station in resonance by altering the dial setting until the optimum combination of settings is found. This completes the whole process, and the receiver is now accurately ganged over both wavebands.

It should be remarked at this point that all the remarks about mis-ganging which were given under that section dealing with the padding condenser circuit apply with equal force to the arrangement using a shaped plate gang condenser. A high capacity to earth from the padding condenser C, for instance, may prevent satisfactory medium waveband ganging from being obtained.

The most common defect experienced with the shaped plate ganging system is that the adjustments described lead to no finality. The adjustments on the medium waveband lead to the oscillator trimmer being either fully screwed up or fully unscrewed. This state is obviously defective, and is to be attributed to an excessive stray capacity across the oscillator tuned circuit, to mis-matching of the oscillator coil, a defective gang condenser, or to an incorrect choice of the intermediate frequency. Since the last is the most usual, some method of checking the frequency is obviously important, and this will be dealt with next, together with the precise adjustments required to the I.F. circuits themselves.

It is almost invariably the practice to employ pairs of coupled tuned circuits for

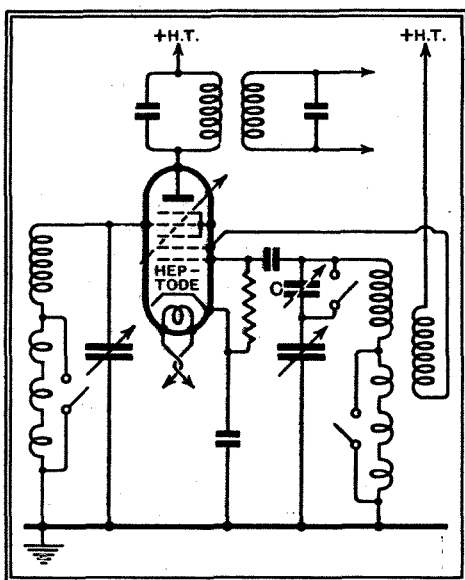

Fig. 1.—The connections of a modern heptode frequency-changer are shown here. A shaped-plate condenser is used on the medium waveband, and the padding condenser C introduced only for long waves.

system employing a shaped plate condenser in the oscillator circuit. This is now the most commonly used in constructional receivers, and it is employed in many commercial sets. It has the great advantage of not requiring a padding condenser on the medium waveband, and so simplifying somewhat the process of ganging. In addition to this, it is the

The Art of Ganging—

the intermediate frequency intervalve couplings. These circuits are usually known as band-pass filters, but actually they are not band-pass filters at all unless the degree of coupling is such that they produce a double-peaked resonance curve. The precise method of adjusting the circuits depends somewhat upon the type of circuits, and, unfortunately, the circuit diagram usually gives no clue as to whether they are true band-pass filters or not. In the case of commercially built receivers, the degree of coupling between the coils which comprise one I.F. transformer is usually fixed, and in many cases it is not sufficiently tight for it to form a true band-pass filter. Each tuned circuit is provided with a trimmer, and the adjustments required are merely to these trimmers.

A station should be tuned in, and each I.F. trimmer must be adjusted for maximum signal strength. If the circuits as a whole then happen to be adjusted to the correct intermediate frequency, they will require no further attention.

I.F. Adjustments

In the case of transformers of the true band-pass type, but which have fixed couplings between the pairs of coils, unsatisfactory results are likely to occur by trimming for maximum signal strength in the manner just described, since it has been found that this leads to an asymmetrical resonance curve, instead of to the correct symmetrical double-humped curve. It is advised, therefore, that in this case the double-hump be removed during the process of trimming by damping the tuned circuits by shunt resistances. A resistance of some 50,000 ohms to 100,000 ohms should be temporarily connected across each I.F. tuned circuit, and then each trimmer adjusted for maximum signal strength. The removal of the resistances will then lead to the correct shape of resonance curve.¹

Some transformers, particularly those intended for use by the constructor, make provision for a variation of the coupling between the coils so that the band-width of the filter may be varied to suit particular requirements. The adjustments are then somewhat more difficult, if only because they are increased in number. At first it is recommended that the circuits be trimmed as described above with very loose coupling between the coils, so that the resonance curve is only single peaked. The correct intermediate frequency should then be obtained by methods to be

described later. The next step is to adjust the coupling to the correct value, and this is more difficult than it would appear, for almost invariably altering the coupling varies the tuning of the I.F. circuits to some extent. The best procedure is generally to make a guess at the degree of coupling required for the preservation of sidebands, then to shunt each tuned circuit by a resistance of 50,000/100,000 ohms, and to trim each circuit exactly to the correct intermediate frequency. The removal of the resistances will restore the correct shape of overall resonance curve,

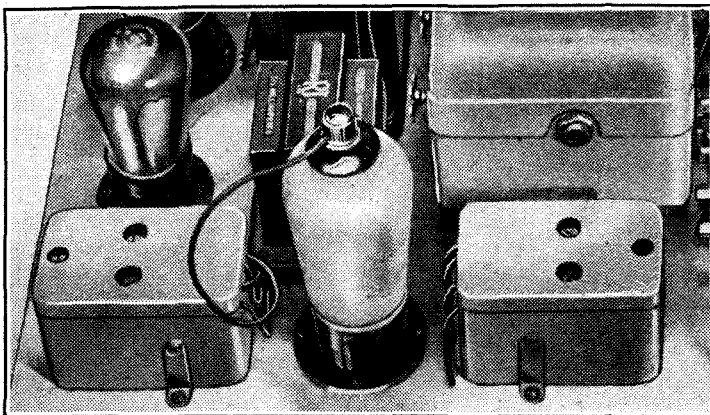

A typical intermediate frequency amplifier embodying iron-cored coils.

and by checking the quality of reproduction and selectivity an idea may be formed as to whether the degree of coupling adopted is satisfactory. If the quality seems of a high order, but the adjacent channel selectivity is low, somewhat looser coupling may with advantage be adopted, so the couplings should be loosened, the coils again shunted by the resistances, and the circuits retrimmed. On the other hand, if the selectivity be high, but the quality rather low-toned, it is a sign that the coupling is too loose, and the above procedure should be reversed.

(To be continued.)

**Modified Stenode
New Set for Amateurs**

IT is announced that the British Radiostatic Corporation, Ltd., of 24, Throgmorton Street, London, E.C.2, have developed a simple form of Stenode receiver specially for home constructors. In the new set, side-band cutting and subsequent tone correction is spread over a number of circuits, the correction being actually carried out, not only by two "tone raising" L.F. intervalve couplings, but by the frequency characteristics of a special loud speaker. The receiver actually embodies a total of five valves (without power rectifier), and, except for the special couplings, is of fairly conventional design.

We are informed that the manufacture of the intervalve couplings will be undertaken exclusively by Belling and Lee, Ltd., while the tone-correcting loud speaker is to be made by Grampian Reproducers, Ltd.

It is claimed that true "9-kilocycle" separation is obtained, except in the most unfavourable circumstances.

**The Diary of an
Ordinary Listener**

A MAJOR attraction to me was the recent performance of "The Geisha" from Rome. I had previously heard this operetta sung in German and was naturally curious to hear how it sounded in Italian. Unfortunately Rome was that evening suffering from a rather bad attack of fading and I could with difficulty hear the "Toy Monkey," but as this song is always associated in my memory with Letty Lind's fascinating voice and personality, I did not altogether regret that it was nearly inaudible. "Star of my Soul," however, came through well, and Wun-Hi's pidgin English in "Chin Chin Chinaman" sounded very quaint—though pleasing—when Italianised. When Rome grew faint I went over to Frankfurt, which was coming in strongly, and greatly enjoyed Mozart's Concerto in E flat, for violin, viola and orchestra, and two fine baritone songs by Herr Pfitzner; later in the evening Luxembourg transmitted a good record of Tchaikowsky's splendid Fifth Symphony, and I finished up the session with the I.B.C. concert of Old Favourites from Poste Parisien.

On Saturday, July 7th, Leipzig gave us a varied programme in connection with the Wireless Announcer's Competition, and, later, both the Brussels stations transmitted a concert of light music by the Remue Orchestra from the Casino, Blankenberghe.

Vichy Chorus in Good Form

Bordeaux-Lafayette broadcast an interesting programme on Monday of last week with Mlle. Cormier and Max Conti as soloists. Huizen transmitted an organ and 'cello recital by de Wolf and Stad of which the first part came through clearly, but towards the end of the programme the intrusion of jazz from a neighbouring wavelength became too apparent and I switched over to Radio Paris for Beethoven's 9th (choral) Symphony. The orchestra of the Casino at Vichy were in fine form. The soloists in the finale were well balanced and I did not experience that sympathetic aching of the throat which I often feel when hearing the chorus wrestling with their top G's and A's. Beethoven was stone deaf when he wrote this Symphony, and I sometimes think that if he had attended many rehearsals he might have put some of the chorus passages a tone or two lower, but this is my personal opinion, and it would probably be regarded as profanity by musical purists.

I should like to suggest that many foreign stations might take an example from the B.B.C. in the matter of punctuality. I have recently tuned in several times, at the appointed hour, to interesting programmes and had to wait impatiently while a seemingly endless discourse was in progress. The Hilversum concert last week in which Cortot played did not get under way till nearly twenty minutes after its advertised time. Atmospherics being exceptionally bad on the long waves, I turned to Frankfurt and heard Sinding's "Rondo Infinito" and Smetana's "Wedding Scenes" played by violin and pianoforte. Thence to Leipzig where the Symphony Orchestra were giving a good rendering of Beethoven's "Eroica" Symphony, and so, via dance music from Radio Paris, to bed.

CALIBAN.

¹ The Wireless World, January 5th, 1934.

UNBIASED

By
FREE GRID

Inventors, Forward!

IT is astonishing what use is being made of wireless by-products by various outside activities. I refer more particularly to photography and cinematography, sister arts, sciences, or hobbies, or whatever else you care to call them, which seem to have taken the photocell completely to their bosom.

Not only has it been pressed into service for the production of a new type of exposure-meter, but its development has been carried through to such an extent that the camera is as fool-proof as it is ever likely to be. Only the other week I came across two remarkable instances of this when paying a flying visit to South-East Europe, and they set me wondering why something similar cannot be achieved in the realms of wireless.

In the first case a cinema camera was shown to me in which a photocell was used to control the battery current to a miniature electric motor which was coupled up to the Iris diaphragm of the camera so that the "stop" was automatically varied according to the value of the light. Thus, if a cloud obscured the sun temporarily in the middle of a "shot" or if the camera user swung his camera from a dark to a lighter scene, the variation of light was automatically

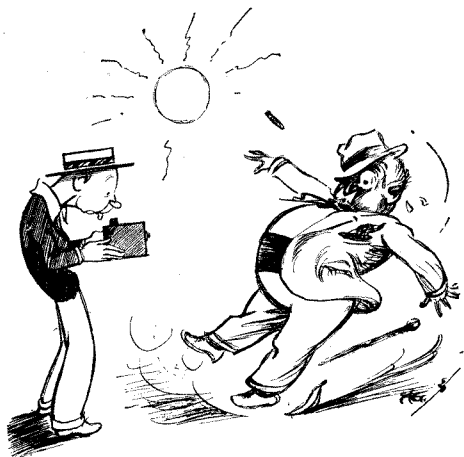

"Of definite entertainment value."

taken care of and the beginner actually put on a better footing than the professional.

The acme of foolproofness was however, achieved, so I thought, in another instrument, a camera of the ordinary type in which a photocell was used for the purpose of preventing the infliction on long-suffering friends and relatives of underdone snaps taken late in the evening when the light was too poor. Under such conditions the cell works a relay which prevents the "trigger" of the camera being operated at all. Thus the arrangement ensures that only photographs of definite entertainment value are taken.

Asked for my views on further refine-

ments which I thought necessary, I could only suggest that the beam-of-darkness-invention, about which I wrote the other week, should be combined with the photocell in order to keep the shutter permanently closed and thus spare us the ordeal of being compelled to wade through such ghastly efforts as Aunt Matilda in bathing costume and minus false teeth which people bring back from the seaside with them at this time of the year.

Developing the Programmes

Since photography is so much indebted to radio, it is high time, I think, that radio did a bit of borrowing from photography and allied activities, and if any of you have got any bright ideas on the subject I shall be pleased to ventilate them. For a start I think that direct reproduction of broadcast programmes straight from the receiver should be forbidden by law. If everybody were compelled to record all received programmes on ciné film and then to develop it, and go through all the other motions beloved of photographers before reproducing the programme, there would not, I feel sure, be half the unexplained suicides that there are to-day, most of which, in my opinion, are due to an overdose of the neighbour's loud speaker on a Sunday afternoon.

Apart from this, I really think that scarcely one man in ten who now drags in a so-called musical excerpt from a half-watt station in Szczepieszyn, amid a welter of catcalls, whistles, and atmospherics, would, if he were compelled to do it in cold blood from his own film record, have the nerve to tell us that he really enjoys this pastime, if, indeed, he ever bothered to develop the thing, which I very much doubt.

A Mistake Somewhere

SOME little time ago I made mention of the fact that a householder in my neighbourhood had openly boasted to me that he possessed no wireless licence. To my intense astonishment this has resulted in the receipt at this office of a perfect avalanche of anonymous postcards in which I am told, in no uncertain terms, to mind my own business, and that, in return for such gratuitous publicity, information will be given to the Water Board concerning my activities with a hose in the small hours of the morning.

I can only think that there must be a mistake somewhere in the matter of identity, and that Water Board inspectors are going to make some rich midnight hauls during the next week or two. What about the P.M.G. co-operating with the Water Board by sending an inspector to all houses adjoining those in which a nocturnal water-waster is laid by the heels as the result of anonymous information?

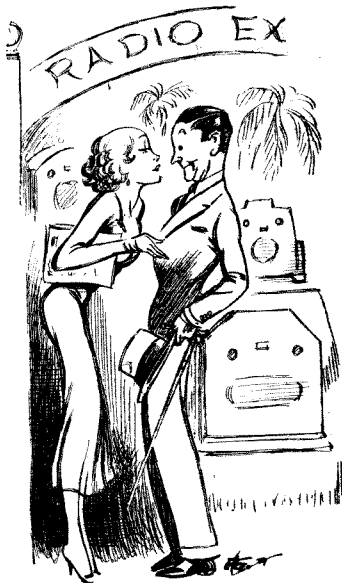

"... to revive their flagging interests."

In Confidence

I SUPPOSE that all of you, like myself, are getting quite excited as August 16th, the opening day of Olympia, draws nearer and nearer. I am not permitted to reveal the great treat that is being prepared for you, having been sworn to strict secrecy on this point. There are, however, I understand, to be three performances daily.

One minor matter I am permitted to disclose, although at the same time I must apologise for troubling you with it. Briefly, it is this. In connection with the great Olympia show which, as I have already intimated, is to be held three times daily, there are to be certain sideshows wherewith the populace can entertain themselves during the intervals. Although I can scarcely imagine anybody being so utterly plebeian as to take any notice of them, perhaps I may be forgiven if I mention that in these sideshows are to be exhibited sundry articles consisting of wireless sets and the parts whereof to build them.

The *pièce de résistance* on each of these stands is to be a competition run on similar lines to the world-famous "Spot the Lady." It will, however, be known as "Spot the Technical Man," and, as in the case of the older form of the amusement, the joke of the whole matter will be that in reality there will be no man to spot, although, paradoxically enough, there will be plenty of ladies. To add interest to the competition, various clues such as "gone to lunch," "You've just missed him," and other terminological inexactitudes will be liberally besprinkled among the mob in order to revive their flagging interests.

As I have already intimated, however, such a thing as a visit to these sideshows simply isn't done by the best people, and I sincerely trust that none of my readers will be so simple-minded as to permit themselves to be inveigled by unscrupulous touts into indulging in such doubtful pastimes. Those not satisfied with the "exhibition" in the R.M.A. theatre must be hard to please.

G.E.C. Battery Compact Three

A Simple But Efficient Detector-L.F. Receiver

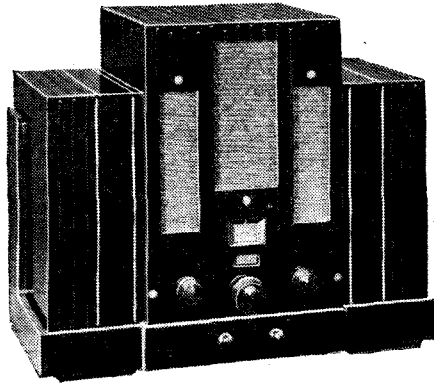

FEATURES

Type.—Table-model receiver with self-contained H.T. and L.T. batteries. Moving-coil loud speaker.
Circuit.—Detector with reaction—L.F. amplifier—triode output valve. Automatic grid bias.
Controls.—(1) Tuning with illuminated degree scale. (2) Reaction. (3) Volume control. (4) Waverange switch. (5) On-off switch. **Price.**—£5 17s. 6d. **Makers.**—General Electric Co., Ltd., Magnet House, Kingsway, London, W.C.2.

BACKED by the research and manufacturing reputation of the General Electric Co., Ltd., this economical battery set may be relied upon to give the maximum possible performance for the initial outlay. In choosing a reacting detector followed by two stages of low-frequency amplification, the designers have undoubtedly made a wise choice of circuit. An H.F. stage, while admittedly giving greater range, considerably adds to the cost of manufacture, particularly if single dial tuning, involving the accurate ganging of circuits, is to be provided. It is true that the reacting detector type of circuit makes greater demands on the skill of the user, but in the case of this set, at all events, he has the satisfaction of knowing that the range available compares very favourably with many battery receivers incorporating H.F. stages for which a much higher price is asked.

Undoubtedly, much of the success which has been achieved in this direction is due to the smoothness of the reaction control and to the fact that regeneration is progressive from the minimum position upwards, and is not crowded within a few degrees below the oscillation point, as is often the case. The tuning circuits are unusually flexible, and enable the user to adjust his receiver to give the best possible performance in any circumstances. The aerial coupling, for instance, may be made through a few loosely coupled turns (position 2) where maximum selectivity is required, or directly to the grid end of the tuned secondary circuit in places remote from a broadcasting station, and where the maximum available input from the aerial is essential and selectivity is of secondary importance.

A separate volume control taking the form of a differential condenser is connected in the aerial. Normally, the lower fixed plate is connected to a socket (Y) which maintains a constant capacity across the tuned circuit, and renders the tuning independent of the position of the volume control. Here, again, the user can rearrange the circuit if desired, for with the lower fixed plate disconnected the control becomes a simple series aerial condenser which reduces the capacity in parallel with the tuned circuit, and so enables the waverange to be extended at the lower end where stations at the bottom of the medium waveband are of special importance to the listener.

The tuning condenser is of the solid dielectric type, and is operated by a slow-motion tuning dial calibrated in degrees. This dial is illuminated from behind by a pilot lamp. The reaction and volume control condensers, which are mounted to right and left of the main controls respectively, are also of the solid dielectric type.

The detector is resistance-coupled to the first L.F. stage, and the circuit is stabilised by decoupling the detector anode circuit. Sockets are provided for the addition of a gramophone pick-up, which is connected across the grid leak to the first L.F. stage. The first L.F. valve, which like the detector is of the metallised type, is transformer-coupled to the triode output valve. Both L.F. stages derive their bias from a resist-

ance connected in the negative H.T. lead so that bias is automatically adjusted to the correct value during the life of the H.T. battery. The total H.T. consumption under working conditions during the tests was found to be 8.8 mA, which is well within the capacity of the standard type H.T. battery provided. Incidentally, a lamp-type fuse is included in the negative H.T. lead.

The loud speaker is of the permanent-magnet moving-coil type, and gives sur-

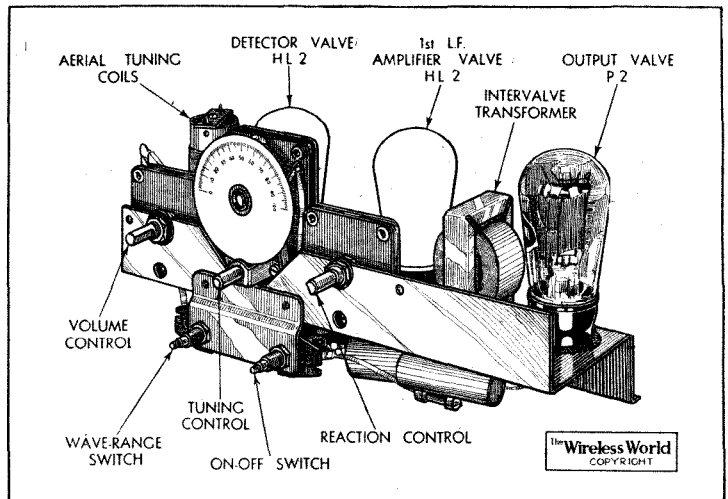

The compact dimensions of the chassis enable both H.T. and L.T. batteries to be housed inside the moulded cabinet.

prisingly good volume for the comparatively small current taken by the output valve. The quality of reproduction is very clear and pleasant to listen to, and if there is not as much bass as one expects to find in more expensive sets, at any rate the reproduction is free from the bugbear of cabinet resonance.

In Central London the Brookmans Park transmitters gave ample volume with reaction at minimum and the volume control turned down by a quarter. Midland Regional also came in strongly, but reaction was required to receive the North Regional station. The listener should be able to rely upon ten or twelve satisfactory programmes after nightfall. On long waves Kalundborg and Radio Paris were the best stations apart from Daventry 5XX, though Huizen was also received at fair strength. No difficulty was experienced in separating Daventry and Radio Paris.

The cabinet is a one-piece bakelite moulding of attractive design; and is arranged to accommodate both the H.T. and L.T. batteries. Even so, the set takes up no more room than the once-popular presentation timepiece. From every point of view—range and choice of programmes, quality of reproduction, economical maintenance and appearance—there can be little doubt that the purchaser of one of these sets will receive very full value for his money.

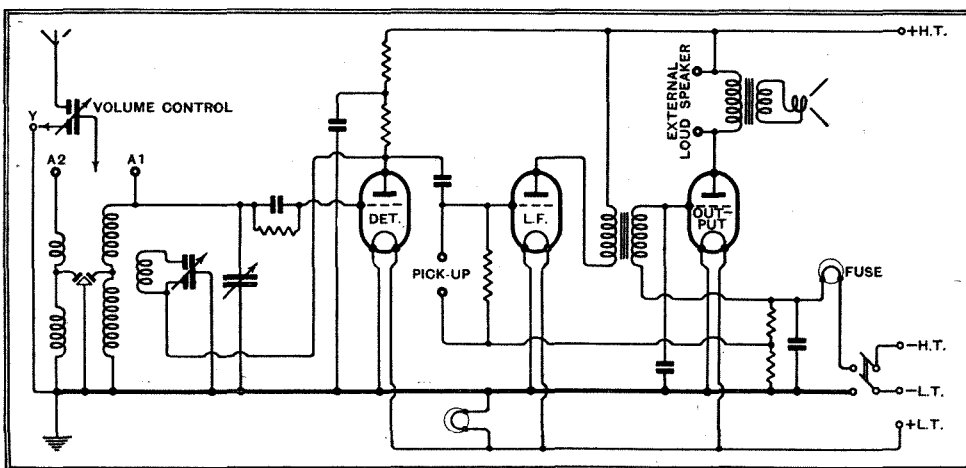

Complete circuit diagram. Automatic bias is provided and the aerial circuit may be modified to conform with the local conditions of reception.

New Radio Products Reviewed

Latest Products of the Manufacturers

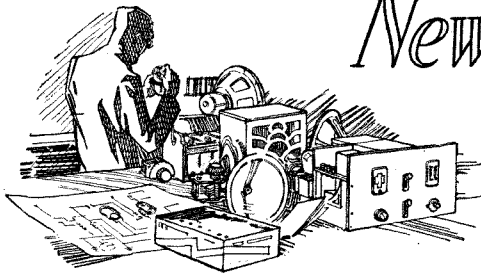

FERRANTI L.P.4 VALVE

THE Ferranti L.P.4 is a super-power triode of the directly heated type giving about 2.5 watts undistorted power output when operated with 250 volts on the anode, -36 volts grid bias, and working into a load of 4,000 ohms. It is intended to be used in A.C. sets with its filament heated from a 4-volt winding on the mains transformer, and it consumes one ampere of current.

Grid bias can be obtained from a resistor of 750 ohms rated at two watts joined between the centre tap on the filament winding and the main H.T. negative line. An alternative arrangement would take the form of a low-resistance potentiometer joined across the filament pins, with the bias resistor connected between the movable contact and the negative H.T. line.

The valve is of low impedance, being of some 870 ohms nominal value, while its mutual conductance is 5.4 mA. per volt. These figures do not relate to the working conditions, but for 100 volts H.T. and zero grid bias. When measured with the maximum working voltages, we obtained the following values with two specimen L.P.4 valves:—

Valve L.P.4.	Amplification Factor.	Mutual Conductance. mA. per Volt.	A.C. Resistance. Ohms.	Anode Current. mA.	Grid Bias Volts.
Specimen 1	4.5	3.6	1,250	47	-35
Specimen 2	4.7	4.0	1,175	40	-35

Our measurements were made with a fixed grid bias potential, but when this is derived



from a resistor there is a compensating effect, and the anode current passed by each valve becomes sensibly the same, the difference being less than one milliamp. between the two specimens tested. Owing to the low impedance of the valve, precautions should be

Ferranti L.P.4 super-power triode giving 2.5 watts undistorted output.

taken to avoid parasitic oscillation, and a 100-ohm resistor joined between the anode

of the valve and the output transformer, or choke, should as a rule be fitted.

The L.P.4 is rated as a 12-watt valve, this being the maximum safe anode dissipation, and the price is 16s. 6d. The makers are Ferranti, Ltd., Hollinwood, Lancashire.

WEARITE SHORT-WAVE COILS

A RANGE of short-wave coils wound on skeleton formers built up from Mycalex, a particularly hard insulating material for which is claimed very small loss at the high radio frequencies, has just been introduced by Wright and Weaire, Ltd., 740, High Road, Tottenham, London, N.17.

The coils are of the plug-in type, and the baseboard fitting is also made of Mycalex. Each coil has two separate windings, one of tinned copper wire, and the other a coil of fine gauge wire of few turns for reaction. The windings are fixed to the former by a

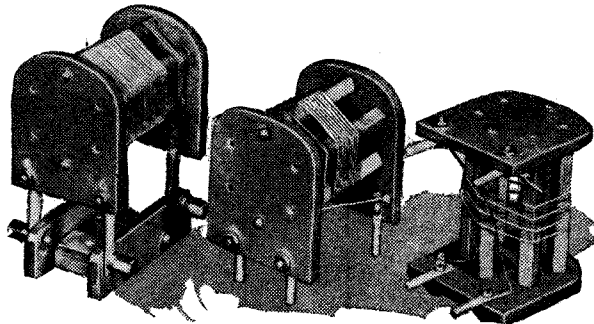

The new Wearite plug-in short-wave coils and baseboard fitting.

special varnish having good H.F. properties.

Tests were made with a simple regenerative detector circuit using a 0.00015 tuning condenser, one of 0.0003 for reaction, and the aerial coupled by a 0.0001-mfd. variable condenser to the high potential end of the reaction winding. This arrangement was found preferable to joining the aerial to the grid end of the tuned winding.

The three coils available cover a wave range of from below 11 metres to just over 100 metres, the respective ranges of each being 10.8 to 27.2 metres, 19.2 to 51.7 metres, and 40.2 to 105 metres. The low-capacity construction of the formers and the holder largely accounting for the ability to tune down to about 10 metres by taking just the usual precautions in the layout of the components.

Reaction was quite smooth and entirely satisfactory with all coils, and would have been obtainable with a smaller condenser. In view of the critical setting to which this condenser can be adjusted without electrical backlash, it would pay to employ one with a slow-motion drive.

The coils are very efficient, and compare well with the best obtainable to-day. They cost 5s. 6d. each, and the base is 2s. 6d.

BULGIN CABLE PLUGS

TWO new cable plugs, one with five pins and the other with seven pins, have been introduced by A. F. Bulgin and Co.,

Abbey Road, Barking, Essex. These are fitted with detachable pins of a new design, the leads now being inserted into holes in the heads of the pins and held in position by small grub screws. To prevent rotation of the pins, which might result in the grub screws short-circuiting, they are sunk into slots moulded in the base.

Cables of quite large diameter can be accommodated, and an insulated washer

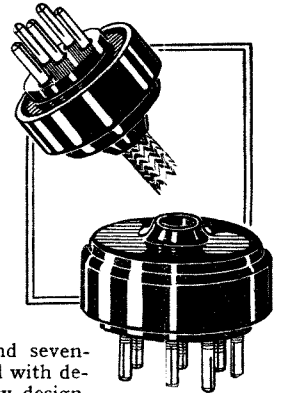

New Bulgin five- and seven-pin cable plugs fitted with detachable pins of new design.

with radial slots serves, in conjunction with the screw-on cap, to provide an efficient wire grip. The five-pin model is converted to a four-pin one by removing the centre pin.

One advantage of the new style is all wire can be connected with the pins removed, which is far easier than with the earlier pattern in which the pins were fixed to the base. The same applies to the seven-pin model as this also incorporates the new style of pin. It fits a standard seven-pin valve-holder and provision is allowed for fitting an additional pin in the centre if required, so making an eight-way plug.

These models are made in black bakelite and cost 1s. 6d. for the five-pin and 2s. for the seven-pin model.

SINGLE-SPAN RECEIVER CHASSIS

PROSPECTIVE constructors of the A.C. model Single-Span receiver may be interested to learn that metal chassis constructed from 1/2 in. thick sheet iron, aluminium-finished, are now obtainable from the London Radio Development Services, Ltd., 56, Hazel Rise, London, N.W.10. These

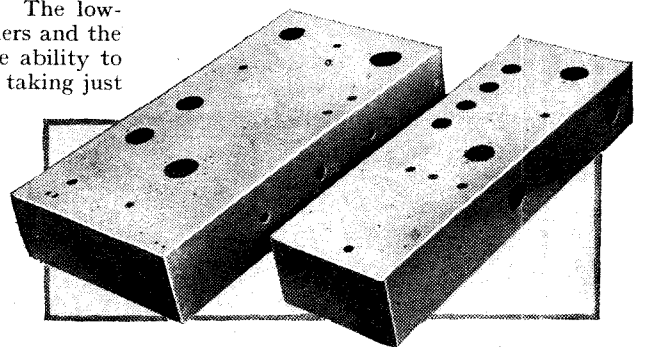

Metal chassis made by the London Radio Development Services, for the A.C. Single-Span receiver

chassis are drilled in accordance with the original layout, the position and size of the holes agreeing with the dimensions given. Corner pieces are fitted with turned-over lugs drilled and threaded to take 2 B.A. screws for fixing in the cabinet, and the price is 9s. for the receiver, and 7s. 6d. for the power pack chassis.

MISCELLANEOUS ADVERTISEMENTS

NOTICES.

THE CHARGE FOR ADVERTISEMENTS in these columns is

12 words or less 3/- and 3d. for every additional word.

Each paragraph is charged separately and name and address must be counted.

SERIES DISCOUNTS are allowed to Trade Advertisers as follows on orders for consecutive insertions, provided a contract is placed in advance, and in the absence of fresh instructions the entire "copy" is repeated from the previous issue: 13 consecutive insertions 5%; 26 consecutive, 10%; 52 consecutive, 15%.

ADVERTISEMENTS for these columns are accepted up to **FIRST POST ON MONDAY MORNING** (previous to date of issue) at the Head Offices of "The Wireless World," Dorset House, Stamford Street, London, S.E.1, or on **SATURDAY MORNING** at the Branch Offices, 19, Hertford Street, Coventry; Guildhall Buildings, Navigation Street, Birmingham. 2; 260, Deansgate, Manchester, 3; 26a, Renfield Street, Glasgow, C.2.

Advertisements that arrive too late for a particular issue will automatically be inserted in the following issue unless accompanied by instructions to the contrary. All advertisements in this section must be strictly prepaid.

The proprietors retain the right to refuse or withdraw advertisements at their discretion.

Postal Orders and Cheques sent in payment for advertisements should be made payable to **LIFFE & SONS Ltd., and crossed & Co. Notes being untraceable if lost in transit should not be sent as remittances.**

All letters relating to advertisements should quote the number which is printed at the end of each advertisement and the date of the issue in which it appeared.

The proprietors are not responsible for clerical or printers' errors, although every care is taken to avoid mistakes.

Set Manufacturers' Surplus, Clearance and Bankrupt Stocks offered in any of these columns may not be Manufacturers' current lines. Radio components advertised at below the list price do not carry any manufacturer's guarantee.

RECEIVERS AND AMPLIFIERS, ETC.

- L. EASTWOOD** Sound System. [6122]
- R. REPRODUCTION** that is Almost Perfect. [6114]
- TYPE H/8 62**; price 13 guineas. Write Dept. A. [6122]
- TWO-STAGE** Resistance Coupled Amplifier, with H.F. pentode input valve; this instrument is very sensitive and therefore extremely suitable for use where very small inputs only are available; supplied complete with B.V.A. valves in steel case. [6122]
- 70**, Pitfield St., N.1. Clerk. 7693. [6102]
- SINGLE** Span Receiver Kit, temporarily wired, £5; cost £7/10.—Write X., 182, Camden Rd., N.W.1. [6114]
- AMPLIFIERS** of Every Description Built to Your Own Specification from £7 to £70; state your requirements, we will do the rest. [6146]
- SOUND** Installation Engineers, 10 years' experience with the best firms.—Universal Radio, 219-221, City Rd., E.C. [6146]
- SINGLE** Span with Latest Quality Amplifier, complete with 10 valves, all to specification; £18.—Lownds, The Cottage, Old Lenton, Nottingham. [6123]
- 1935** Models 4 Valve Superhet. A.C. or D.C., M.C. Speaker, £3/19/6; 5 valve, £5 5s. including valves; approval.—Royal, 5, Buckingham Rd., London, E.18. [6126]
- H.M.V.** 120 Watts A.C. Amplifier 110/240 Volts, 2 D.A. 60 valves in output stage, suitable for gram., radio or mic. work, current for microphone incorporated; less valves £12/10. [6126]
- G.E.C.** 60 Watts P.A. Amplifiers in Teak Cases, last few; to clear £2/10 each. [6126]
- IGRANIC** 60 Watt A.C. Amplifier, 110/230 volts, metal chassis, complete with valves; £12/10. [6126]
- MARCONI** 60 Watt "Rack" Amplifier, converter driven, D.A.60 in output stage; less valves £6/10. [6126]
- LARGE** and Varied Stock of P.A. Amplifiers, microphones, speakers, converters, heavy duty chokes, transformers, meters, condensers, &c.; stamp for lists and prices, callers invited. [6133]
- H. FRANKS**, 23, Percy St., Tottenham Court Rd., W.1. Museum 8585. [6133]
- ELECTRIC** Continuous Gramophone, plays 36 records in continuous preselected order without any personal attention, automatically changes needle, cost £170; accept £35.—The Exchange Mart, 67, Porter St., Hull. [6100]
- £4/10.—200-250 A.C. band pass S.G.3. in attractive walnut case similar to Lotus, complete with valves and Rola M.C., 3 gang Radiophone, screened coils, listed £10/10, brand new; ditto table radiogram, Simpson turntable, Belling Le; pick-up, complete; £5/15. [6093]
- 55/-**—S.G.3 band pass battery receiver, as above, with P.M. Rola or Sonochoord (without valves, batteries), listed £8/8; similar set S.G.3, 2-gang Polar, Ormond loud speaker, in identical cabinet, for 42/6; all c.o.d., carriage forward.—Kay, 167, City Rd., London, E.C.1. [6093]

PILOT AUTHOR KITS

Exact to Specification

EXPORT ORDERS Simply send full cash value plus a suitable amount for half carriage charges and any surplus will be immediately refunded. Packed free, we pay half carriage. Air Mail charges extra. PETO-SCOTT, established in 1919, are the largest Radio-by-Mail House in the World. **Hire-purchase terms are NOT available to Irish or Overseas Customers.**

SINGLE SPAN RECEIVER and QUALITY AMPLIFIER

RECEIVER UNIT

Comprising Author's Kit of first specified parts for Receiver Portion only, including coils and condensers, ready mounted on Plymax Chassis Assembly, but excluding valves and cabinet.

Cash or C.O.D. Carriage Paid. **£8 13 6**
Or 12 monthly payments of 16/-.

AMPLIFIER UNIT

Comprising Author's Kit of first specified parts for Amplifier Portion only, including Ready-Drilled Chassis but excluding valves and Cabinet. Cash or C.O.D.

Carriage Paid. **£10 10 0**
Or 12 monthly payments of 19/3.

COMPLETE KIT

Comprising Receiver and Amplifier Kit, including complete set of 10 specified valves, but excluding Cabinet.

Cash or C.O.D. Carriage Paid. **£27 8 0**
Or £7 8 od. deposit and 11 monthly payments of 40/-.

THIS WEEK'S BARGAIN

Shop-soiled M.L. Dual Output Generator 8 volts 4-6 amps. D.C., and 400 volts. 80 m/a D.C. Guaranteed perfect working order.

List Price £15. Bargain Price £5 10 0.

PETO-SCOTT CO. LTD.
77 CITY RD., LONDON, E.C.1 Phone: Clerkenwell 9406/7
West End Showrooms: 62, High Holborn, London, W.C.1. Est. 1919.

SOUND AMPLIFYING EQUIPMENT

for all purposes, with undistorted A.C. outputs from 2 to 150 watts — Heavy duty M.C. speakers, microphones, etc. Tannoy sound equipment is used whenever quality is the first consideration.

Consult:—
THE
SOUND
PEOPLE

TANNOY

PRODUCTS

(GUY R. FOUNTAIN LTD.)

**CANTERBURY GROVE,
WEST NORWOOD,
LONDON, S.E.27.
and Branches.**

Telephone: Streatham 6730 (3 lines).

BATTERY CHARGER.

Will handle 50 accumulators in series at once, with sliding resistance and meter. In steel cabinet. **TRADE PRICE £8 8 0 net. Terms arranged.** Models for A.C. and D.C. mains, also H.T. chargers, with Westinghouse or valve rectification. Chargers made specially to order. Send specification for Quotation.

FEL-ECTRIC RADIO, Garden St., SHEFFIELD

NUMBERED ADDRESSES.

For the convenience of private advertisers, letters may be addressed to numbers at "The Wireless World" Office. When this is desired, the sum of 6d. to defray the cost of registration and to cover postage on replies must be added to the advertisement charge, which must include the words Box 000, c/o "The Wireless World." All replies should be addressed to the Box number shown in the advertisement, c/o "The Wireless World," Dorset House, Stamford Street, London, S.E.1. *Readers who reply to Box No. advertisements are warned against sending remittance through the post except in registered envelopes; in all such cases the use of the Deposit System is recommended, and the envelope should be clearly marked "Deposit Department."*

DEPOSIT SYSTEM.

Readers who hesitate to send money to advertisers in these columns may deal in perfect safety by availing themselves of our Deposit System. If the money be deposited with "The Wireless World," both parties are advised of its receipt.

The time allowed for decision is three days, counting from receipt of goods, after which period, if buyer decides not to retain goods, they must be returned to sender. If a sale is effected, buyer instructs us to remit amount to seller, but if not, seller instructs us to return amount to depositor. Carriage is paid by the buyer, but in the event of no sale, and subject to there being no different arrangement between buyer and seller, each pays carriage one way. The seller takes the risk of loss or damage in transit, for which we take no responsibility. For all transactions up to £10, a deposit fee of 1/- is charged; on transactions over £10 and under £50, the fee is 2/6; over £50, 5/-. All deposit matters are dealt with at Dorset House, Stamford Street, London, S.E.1, and cheques and money orders should be made payable to Liffe & Sons Limited.

SPECIAL NOTE—Readers who reply to advertisements and receive no answer to their enquiries are requested to regard the silence as an indication that the goods advertised have already been disposed of. Advertisers often receive so many enquiries that it is quite impossible to reply to each one by post. When sending remittances direct to an advertiser, stamp for return should also be included for use in the event of the application proving unsuccessful.

Receivers and Amplifiers, Etc.—Contd.

- BRAND** New Receivers, complete, unused and perfect, 1934 models, Corsor Console 3468 A.C. mains, 4 valve, 7 guineas; Aerovine Finch S.G.3, 5 guineas; Alba Model 21 S.G.3, 5 guineas.—144, Swansea Rd., Llanely, Carm. [6122]
- ARMSTRONG** Latest Radio-Gram Chassis, incorporating advanced designs, Superheterodyne including Marconi valves, Royalties paid, £6/18/6; Armstrong 4 valve, 3 pentode chassis, complete, £5/18/6; Universal 4 valve chassis, complete, £5/18/6.—Armstrong Company, 100, King's Road, N.W.1. [6138]
- OUR** Kit for "Wireless World" Quality Amplifier, complete in every detail, including valves, amplifier only, £8/10; feeder unit, 36/-; carriage paid; cash with order or c.o.d.; send for detailed list of components.—Ward, 2nd Floor, 45a Farringdon St., London, E.C.3. Holborn 9705. [5760]
- PUBLIC** Address Amplifiers.—A.C. mains, three stage, 21 watts, undistorted A.C. output, complete with valves, £15; universal A.C./D.C. three stage, 7 watts output, complete, £13; guaranteed 12 months; trade supplied; deferred terms.—D. E. Clarkson, B.Sc. (Eng.), 45, Manor Rd., Wallington, Surrey. Phone: Wallington 3953. [6120]
- CECOPHONE** 6-valve Supersonic Heterodyne, including valves, coils, 13 to 720 metres, connecting cords, etc., excellent condition, hardly used; also Marconiphone model 255 6-valve portable superheterodyne, excellent condition, complete; above for sale separately or together; first reasonable offer accepted.—Richard Nash, Rackendon Lodge, Queen's Rd., Weybridge. [6103]

MAINS EQUIPMENT.

- VORTEXION** Leads Again.
- VORTEXION** Specified Single Span Model, 350-100 m.a., 4v. 5a. C.T., 4v. 2.5a. C.T., 4v. 1a. C.T.; 25/-, less terminals, 23/-, less 5-year guarantee 21/-; power chassis, complete, £3/10; steel chassis only, 7/6; also normal model, shrouded, at 16/-, special shrouded choke 12/6.
- VORTEXION**—Quality amplifier or super monodial, 425-0-425, 120 m.a., 4v. 6-8a. C.T., 4v. 3a. C.T., 4v. 1a., 4v. 1a., super shrouded, core size 2 1/2 in. x 1 1/2 in., 2 1/2 regulation primary engraved insulated terminals, weight 14lb., 26/-, carriage 2/-; normal shrouded, 22/-; open type, 20/-, post 1/3; speaker field replacement choke, 16/-; special output transformer, to "W. W." spec., 12/6.
- VORTEXION** 7-30h, 120 m.a. Choke, 215 ohms, in die cast shrouding to match; 12/6.
- LIMITED**, but unequalled. Good enough for a "Wireless World" specification is good enough for you.
- VORTEXION** Cost Little More than the Cheapest, but unequalled by the dearest.
- VORTEXION** Standards Despatched by Return.
- VORTEXION** A.C./34 used by author in construction of A.V.C. Triodes, as illustrated; 18/6.
- GUARANTEED** 12 Months, and within 5% normal and 2 1/2% super models, neat shrouding, with detachable feet, as used by Government Departments, etc., etc.; any model guaranteed 5 years at extra cost of 2/.
- ALL** Secondaries Centre Tapped
- VORTEXION**—250-0-250 60 m.a. 4v. 1 to 2a., 4v. 2 to 4a., open type, 10/-; shrouded, 12/6; post 9d.

(This advertisement continued on next page.)

Mains Equipment.—Contd.

(This advertisement continued from previous page.)
VORTEXION.—Ferrocart III, 350-0-350, 60 m.a., 4v. 2.5 C.T., 4v. 3.5 C.T.; open type 13/6, shrouded 16/-; post 9d.
VORTEXION.—Super model for H.T.8 or 9 or 10, 4v. 1 to 2, 4v. 2 to 4; open type 14/6; shrouded 16/6; post 1/-
VORTEXION.—350-0-350, 120 m.a., 4v. 2 to 5a., 4v. 2 to 4a., 4v. 2.5a.; open type, 14/6; shrouded, 16/6; super shrouded model, weight 11lb., 4 filaments to specification, 21/-; post 1/3.
VORTEXION.—400 or 450 or 500v. 120 m.a., 4v. 2 to 5, 4v. 2 to 5, 4v. 2, 5a.; open type, 19/-; shrouded, 23/-
VORTEXION.—400 or 450 or 500, 150 m.a., 4v. 4a., 4v. 2.5, 4v. 2, 4v. 2, 4v. 2, core size 2 1/4 x 1 1/4 in., a super job, 2% regulation, 35/-; shrouded, with terminals; less terminals, 30/-; open type, 26/-; post 1/3.
VORTEXION Auto Transformers to B.E.S.A. Specification, 100, 110, or 120v. to 200, 220, or 240 volts, 60 watts, 9/-; post 9d.; 120 watts, shrouded 12/6, open type 10/6, post 1/-; 200 watts, shrouded 16/6, post 1/-; 2,000 watts, £4/10.
VORTEXION 1,000-watt Transformers; £4/10, carriage free.
VORTEXION 30h. at 60 m.a. Chokes, 5/6; 40h. at 60 m.a., 8/6; 30h. at 150 m.a., 200 ohms, 10/6 open type, 12/6 shrouded.
VORTEXION Transformers Made to Your Specification; price according to wattage, 6v. filaments same price unless wattage grossly exceeded; special quotations by return.
VORTEXION (S. A. BROWN), 182, The Broadway, Wimbledon, S.W.19. Tel.: Liberty 2814. [5901]
SERADEX Products Specified for Universal Single Span Receiver, see displayed advert. on page iii.
SERADEX P.M. Speaker Supplies Now Available, equal to other makers' models at 63/-, 9 ratio transformer, for Class B, etc., 32/6.
SERADEX E.8 Speaker, 2,500 ohm field, etc., very sensitive, 25/-.
SERADEX Measuring Instruments, 2 1/2 in. scale bakelite cases, flush panel mounting, any reading to order, type F reads A.C. or D.C. accuracy 2%, back leads 6/- each; send for details of our full range.
TREVOR PEPPER, 575, Moseley Rd., Birmingham, 12. [6091]
TANTALUM for A.C. Chargers H.T. and L.T. special offer, 1,000 Tantalum strips, 5 1/2 in. x 1 1/16 in. suitable for trickle chargers, 1/3 each.—Blackwell's Metallurgical Works, Ltd. Garston, Liverpool. [5039]
HOYNE'S Transformers, fitted with tapped and screened primaries, filaments, all centre tapped, stout cast aluminium clamps and clearly marked terminal strips are fitted to all models; write for list.
HOYNE'S Components are Guaranteed for One Year; one type only manufactured, the best, as used by many well-known set manufacturers after testing all others.
HOYNE'S—"W.W." transformers, wound strictly to specification of author; "W.W." test reports, June 22nd: "The insulation is particularly good throughout... the transformer is satisfactory in all respects."
HOYNE'S.—Push-pull quality amplifier transformer, 25/-, post 1/3; 7/30 henrys choke, 9/6, post 9d.; 20 henrys, 7/6, post 9d.
HOYNE'S.—Single span, 15/-, post 1/-; choke, 10 henrys, 7/6, post 9d.
HOYNE'S.—Everyman A.C. super transformer, 12/6, post 1/-; choke, 10 henrys, 7/6, post 9d.
HOYNE'S.—A.V.C. Straight Four transformer, 18/-, post 1/3; choke, 26 henrys, 120 m.a., 140 ohms, 9/6, post 9d.
HOYNE'S.—A.V.C. Three transformer, 12/6, post 1/-; choke, 30 henrys, 60 m.a., 7/6, post 9d.
HOYNE'S.—250-0-250v. 60 m.a., 4v. 1 to 2a., 4v. 2 to 4a., 10/-, post 9d.; with extra 4v. 1 to 2a. winding, 12/6, post 1/-
HOYNE'S.—Ferrocart III, 350-0-350v. 60-70 m.a., 4v. 2 to 5a., 4v. 2 to 4a., 12/6, post 1/-; with extra 4v. 1 to 2a. winding, 13/6, post 1/-
HOYNE'S.—500-450-0-450-500v. 140 m.a., 4v. 2 to 4a., 4v. 4 to 6a., 4v. 2a., 4v. 2a., 27/6, post 1/3; weight 11lb.
HOYNE'S Transformers, built to specifications up to 1 K.V.A., keenest prices, best materials and workmanship; quotation by return.
M. J. HOYNE, ALL-POWER TRANSFORMER, Ltd., M. Offices and Works, 8a, Gladstone Rd., Wimbledon, S.W.19. Tel.: Liberty 3303. [6079]
A.C. or D.C. Chargers for 2 to 200 Cells at Low Prices; state requirements; dynamos and rotaries in stock; all sizes; Brown's Genometer, battery superseders for H.T. for 2v. or 6v. input, 37/6 and 52/6; television and sewing machine universal motors, 25/-; lists.—Electradix Radios, 218, Upper Thames St., E.C.4. [0398]
PARAMOUNT Mains Transformers are Equal to Any, yet unequalled in price; guaranteed for 12 months, and manufactured from the finest British materials; they are fitted with smart aluminium shrouds and frames, all filaments centre-tapped; finest quality insulating paper between each layer, and thoroughly tested before leaving our works.
PARAMOUNT 500-0-500v. or 450. or 400, 120 m.a., 4v. 5a., 4v. 4a., 4v. 2.5a., shrouded, screened primary, 21/-; open, 18/-; post 1/3.
PARAMOUNT Single Span 350-0-350v. 100 m.a., 4v. 5a., 4v. 2.5a., 4v. 1a., shrouded, screened primary, super regulation, 18/6, post 1/3.
PARAMOUNT 350-0-350v. 120 m.a., 4v. 2.5a., 4v. 2-4a., 4v. 2.5a., shrouded, screened primary, 16/-, post 1/-
PARAMOUNT 250-0-250v. 60 m.a., 4v. 1-2a., 4v. 2-4a., 10/-; shrouded, 12/-, post 9d.
PARAMOUNT Chokes 30h. 60 m.a., 5/-, post 9d.; 20h. 120 m.a., 8/-
PARAMOUNT Auto-transformers 100-120/200-250v. or vice versa, 60 watt 8/-, 120 watt 10/-, shrouded 12/-, post 9d.
PARAMOUNT Guaranteed Electrolytic Condensers, 4-0.4 mfd. 500v. peak, 3/6, post 3d.
PARAMOUNT for H.T.8, 9, or 10 4v. 1-2a., 4v. 2-4a., 15/6, shrouded, post 1/-
PARAMOUNT.—Write for details of our super inductance 5-valve receiver, with Rola moving coil speaker, Colvern Ferrocart coils, Polar condensers, and variable Mu valves; price £9; there is no greater value on the market, irrespective of price.
PARAMOUNT Mains Transformers, manufactured by Brock & Salter, 66, Hartfield Rd., Wimbledon, S.W.19 (one minute from Wimbledon Station). Tel.: Liberty 3226. [5998]

ACHIEVEMENTS?

18 months ago we introduced the Hartley Turner loud speaker. Nowadays, we find almost every post bringing letters from customers who express their gratitude at being able to buy an instrument which has given them a new interest in reception. Every Hartley Turner user has, at some time or other, possessed speakers which were perfect—according to the makers. A man does not lightly throw away a speaker for which he may have paid anything up to £10. All Hartley Turner users have done so.

Our rapidly rising sales have proved that there is a market for a well-designed speaker of "musicianly" quality. Other makers are now making an appeal with higher priced speakers with the pluperfect reproduction. Well! Well! Well!

All we can say is: If you can find a loud speaker which distorts less than the Hartley Turner, then you ought to buy it. We sell ours at

7 gns. (D.C. Model) and 8 gns. (A.C. Model)

HARTLEY TURNER RADIO LTD., Thornbury Rd., Isleworth, Mdx.

Telephone: HOUnslow 1854.

£2,000 LABORATORY SALE

Our apologies are due for delay with COMPLETE LIST OF APPARATUS as this was larger than expected and printing delayed. However, the Laboratory List is NOW READY and if any benefactor to a Technical College sends us a cheque for £900, we will accept this low figure for clear. Send stamped envelope for this List please.

FREQUENCY RECORDS

For Testing, Speaker, Set and Microphone. These Gramo. Records are all cut to constant amplitudes and the harmonic content is less than 5 per cent.
Disc 89, 1000 cycles per sec. two-minute band; for general test.
Disc 85, 5000 and 6000 cycles per sec. one minute of each.
Disc 87, Short bands of 20, 30, 40, 50, 60, 70 cycles per sec.
Disc 86, Short bands of 80, 90, 100, 125, 150, 175.
Disc 85, Short bands of 200, 250, 300, 350, 400, 450.
Disc 84, Short bands of 500, 600, 700, 800, 900, 1000.
Disc 83, Short bands of 1250, 1500, 1750, 2000, 2250, 2500.
Disc 82, Short bands of 2750, 3000, 3250, 3500, 3750, 4000.
Disc 81, Short bands of 4250, 4500, 4750, 5000, 5250, 5500.
Disc 80, Short bands of 5750, 6000, 6250, 6500, 6750, 7000.
A new needle should be used for every test.
PRICE Per Record 2/6 Set of Ten £1

The famous Eisel Public Address and Band Mike (Reisz principle) 55/- Highest quality uniform response. Can be obtained from us only. Worth £5, but our Price, 55/- Stand 15/- extra. Screened imp. matched transformer, 7/6.
We make 25 types of Microphones to suit all. Prices from 5/6. Special Instructive Leaflet "W" Free.
Transmitters Hand Model 50/-
ELECTRADIX RADIOS, 218, Upper Thames Street, E.C.4. Telephone: Avenue 4611.

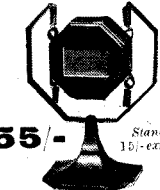

CABINETS.

MANUFACTURERS' Clearance.
ULTRA "Panther," a modern cabinet, with contrasting figured walnut veneer panels. 20x17x11, 13/6; pedestal type, 35x22x12, 30/-, undrilled; photo sent on request.
SET and Speaker Cabinets; 5/- upwards.
RADIOGRAM Cabinets; 37/6 upwards
SPEAKER Cabinets; 4/6 upwards.
SEND Particulars of Your Requirements (giving size of set, etc.), or call and make your choice from our stocks of over 100 different types; from 3/6 to £4/10.
REFER to Previous Advt. for Detailed List of Bargains.
H. L. SMITH and Co., Ltd., 287-9, Edgware Rd., London, W.2. Tel.: Padd. 5391. [6052]
ILLUSTRATED List of Radio-Gramophone Cabinets at Bargain Prices, and descriptive literature of the Howe box baffle, recommended by the B.B.C., post free.—Gilbert, Cabinet Maker, Swindon. [0431]

DYNAMOS, ETC.

ROTARY Converter, 220 D.C. to 230 A.C., 100 watts, 37/6; another, slightly smaller, 32/6, less smoothing. —67, Porter St., Huil. [6101]
M.L. Motor Generator: input 230v. D.C., output 500v. 100 m/A D.C. in guaranteed condition, list price £14; bargain, £5.—Balden, 4, St. John's Terrace, Clayhill, Enfield. [6107]
PUBLIC Address Surplus.—Converters, M-L, 12v. input to 230v. A.C., 37 amps., £4; M-L, 18v. input to 500v. 160 m.a., £5; Crypto, 220v. input to 200v. A.C., 440 watts, £5; Mortley Sprague double current generator, 12v. 7.5 amps., 1,050v. 120 m.a., £4/10; cinema Epoch speaker, £4; four Amplion P.A. horns and units, 17/6 each; four Truvox horns, 10/- each; six Exponential Truvox horns, in waterproof boxes, 37/6 each; two Browns moving coil horn units, £2 each; three Film Industry units, L.S.6. £4/10 each; Western 555W. unit, £9; two Western 4211D. valves, net £2 each.—Davis Sound Systems, 154, Hamlet Court Rd., Westcliff. [6143]

GRAMOPHONES, PICK-UPS, RECORDS.

WEBSTER Automatic Record Changer 230 A.C., £6; Presto recording outfit, cost £30, accept £7/10.—Wheelwright, 360, Manchester Rd., Bradford, Yorks. [6105]

LOUD-SPEAKERS.

27/6 !!!—Brand new B.T.H.-R.K. speakers, 6v. field, suitable for P.A. work, etc.
£2 7/6 !!!—B.T.H. speakers, as above, for 100-250v. A.C., complete with field rectifier.
MAGNAVOX D.C.152 (9in. cone), 22/6; Magnavox 154 (6 1/2 in. cone), 16/3; all with hum-bucking coils, power or pentode transformers and 2,500 or 6,500-ohm fields; Magnavox P.M.254, 18/-
ATTENTION to All Orders Within 24 Hours; carriage paid; cash with order or c.o.d.
WARD, 2nd Floor, 45, Farringdon St., London, E.C.4. Telephone: Holborn 9703. [5723]

VAUXHALL.—Magnavox permanent magnets, universal, suitable for Class "B," power or pentode, 6in. cone 15/6; 7in. cone 17/6; 10in. cone 25/-; mains energised 2,500 or 6,500, 10in. cone 23/-; 7in. cone 15/3; brand new, with hum-bucking coils; state power or pentode transformer; unused manufacturers' stock; immediate delivery, carriage paid, cash with order or c.o.d.—Vauxhall Utilities, 163a, Strand, W.C.2. Temple Bar 9338. [6136]

DEGALLIERS Offer Set Manufacturers' 1934 boxed Surplus, positively last lot until October, all carriage paid, cash with order or c.o.d. Moving coil speakers: Utah Midgets, 2,500, at 14/6 (U.S.A.); Rolas F.6 (7 1/2 in. diameter), 2,500 ohms (110-175v. D.C.), 6,500 ohms (200-250v. D.C.); list 35/-, at 18/-; F.7 (9in.), voltages as in F.6, list 47/6, at 25/-; permanent magnets, F.6 P.M., 7 1/2 in. diameter, list 49/6, at 23/-; F.7 P.M. (9in.), list £3, at 33/-; energised speakers, incorporate humbuckers, state if for power or pentode.—Degalliers, 4/21, Upper Marylebone St., London, W.1. [6130]

TRANSMITTING APPARATUS.

X-TALS, 1.75 m.c., 4/6; 3.5 m.c., 6/-; any frequency. —G.S.V., 58, Southill Terrace, Crackenedge, Dewsbury, Yorks. [6113]

VALVES.

ALL Types of Brand New American Valves in Stock; first-class makes, guaranteed.
247, 235, 531, 89, 18, 19, 45, 59, 6A7, 15, 42, 83, 43, 12/-; 25Z5 14/6; U.X.171A, U.X.199, U.X.280, U.X.245, list 22/6; U.Y.227, 7/6; U.X.250, U.X.210, U.Z.231, 17/3; U.X.867 photocells, 25/-; various transmitting valves in stock; post paid; cash with order or c.o.d.
WARD, 2nd Floor, 45, Farringdon St., London, E.C.4. Phone: Holborn 9703 [5723]

FREE.—List of American and non-ring valves.—Epton, 95, New Rd., Chingford, E.4. [6086]

SURPLUS Valves.—All brand new; battery types, 2-volt, H.F.2, L.F.2, L.P.2, 1/9; super power, P.P.2, 2/6; screens and pentodes, 3/9; A.C. mains, 4-volt 1 amp. general purpose, 3/3; power, 4/7; screens and pentodes, 4/6; full wave rectifiers, 3/6; postage paid, cash with order, or c.o.d. over 10/-.—Clarion Radio Valve Co., 685, Tyburn Rd., Ealing, London, W. [6115]

PREMIER SUPPLY STORES Announce the Purchase of the Complete Stock of a World Famous Continental valve manufacturer; all the following standard main types fully guaranteed, 4/6 each; H.L., H.L.L., L. power, medium, high, low mag., and variable mu screen grids, one, three and four Watt A.C. output, directly heated pentodes, 250v. 60 m.a. full wave rectifiers, d.c. types, 20v. 18 amp., filaments, screen grid H, H.L. power.

THE Following Types, 5/6 each; 350v. 120 m.a., full wave rectifier, 500 v. 120 m.a., full wave rectifier, 2 1/2 Watt indirectly heated pentode.
THE Following American Types, 4/6; 250, 112, 171, 210, 245, 225, 47, 46, 24, 35, 51, 57, 58, 55.
PREMIER SUPPLY STORES, 20 and 22, High St., Clapham, S.W.4. [6011]

COMPONENTS, ETC., FOR SALE.

R. RYALL'S RADIO, 33, Chancery Lane, London, W.C.2 (nearest Tube: Chancery Lane; bus 67 passes door, or tram to Savoy St.). Holborn 3529. Open Saturday afternoon. Close 7 p.m., Saturday 5 p.m., Thursday closed 1 o'clock.

SET Repairs, any commercial or amateur built set serviced, at "Trade" prices, British or American, satisfaction guaranteed.

BRITISH Radiophone Volume Controls, with mains on-off switch, new, 5,000, 10,000, 15,000, 20,000, 50,000, 100,000, 2/6 each.

BRITISH Radiophone Radiopaks: B.P. superhet 110 kc/s, 30/-; postage 1/3; sets British Radiophone 3-coil units on base, with terminals, wave change, switch and knob, 2 H.F., 8/9; B.P. superhet 110 kc/s, 8/9, postage 9d.

FERROCART Coils, G1-2-8, 25/-; G10-14-8, 25/-; all with mains switch.

T.C.C. 0-1 Non-inductive Tubular Condensers, 10d. each, 350v.; T.C.C. electrolytic 15 mfd., 50v., 1/4, new; T.C.C. 0.01 mica, type M, 1/-; T.C.C. 0.0001, type M, 5d.; H.M.V. condenser blocks, 250v. working, 4x4 mfd., 3/6; 4x4x1x1x1/2 mfd., 4/-; T.C.C. 0.1x0.1, 450v. working, 1/6.

HELSBY Non-inductive Condensers, bakelite cased, 4 m.f., 250v., 3/-; Ryall's 4 m.f., 250v.w., 2/-; 750v.w., 6/6; Dubilier, 2 m.f., 250v.w., 1/6; Dubilier electrolytic, 450v. peak, 3/5, 8 m.f.; ditto, 4 m.f.

UNIKNOBS, Polar 2-gang, new, brown, 8/-, with cover, 9/6; Polar disc drive, complete with Polar No. 4 0.0005 condenser, listed 9/-; 4/- the two; R. and A. type output transformers, 18-23-32-1, new, 5/-; Paxolin formers, with guiders, lin., 8d.; R.I. Hypermite transformers, 6/-, second-hand; R.I. Parafred transformers, 5/-, second-hand.

RADIOPHONE Disc Drives, less escutcheon, fit 5/8in. spindle, read 0-100 from left to right; 1.6 post free.

R. [6118]

24. MILDWAY RADIO EXCHANGE Offers the Following, sound and perfect; cash with order or c.o.d.

KOLSTER-BRANDES "Kolstar" 7-valve A.C. Mains Receiver, complete with valves and moving coil speaker in solid walnut cabinet, valves used being 3 Mullard S.4.V.B.s, Mazda A.C.2/H.L., A.C./H.L., A.C./Pen; also Philips rectifier, suitable for mains of 200-250 volts, offered in brand new condition at the very low price of £7.

EKCO Mains Units.

TYPE K12, suitable for sets up to 3 valves, output 150v. 12 milliamps, incorporating trickle charger for 2, 4 or 6v. accumulators, 200-250v. mains; 35/- each. TYPE A.C.25, output 150v. 25 milliamps, having 4 tap-pings, 2 variable, listed at £3/17/6; our net price, 33/6.

TYPE K.25, output 150v. 25 milliamps having 4 tap-pings, 2 variable, with charger for 2, 4 or 6v. accumulator, listed at £5/7/6; our price 39/- each.

SPECIAL Offer Ferranti Inductor Dynamic Speakers, equal and in fact better than cheap moving coil speakers; 20/- each.

1934 Ferranti "Lancastria" Superhet Receiver, complete with valves boxed; £8/10, listed at £14/3/6.

1934 Cossor Model 347 4-valve A.C. Mains Receiver, with moving coil speaker and complete with valves; £7.

1934 Cossor Model 342 3-valve Battery Receiver, complete with valves and moving coil speaker, listed £7/2/6; our net price £4/2/6.

MARCONI Model 260 4-valve Battery Receiver, complete with valves and moving coil speaker; £5.

MARCONI Model 252 3-valve Battery Receiver, complete with valves, in walnut cabinet, screen grid, pentode output, limited number only; £3/15 each.

MARCONI Model 248 2-valve Battery Receiver, with valves and speaker, in walnut cabinet; 25/6 each, limited number only.

TELSEN Super Selective Six Receiver, 6-valve superhet battery operated, including valves; £5.

SPECIAL Offer: Lotus All-power Units, giving H.T., L.T., and grid bias, complete and brand new, for mains of 200-250v.; 37/6 each.

VARLEY A.V.C. Units, 5/- each; Wearite ditto, 5/- each; Multitone Class "B" adaptor, less valve, 22/6, valve 5/-; Varley Nicore I transformer, 9/6; hypercore choke, 10/-; Audirad choke, 4/6; Westinghouse H.T.1, 17/6; Ferranti transformer for same, 6/6; Varley ditto, 5/-.

FERROCART G1, G2, G3, 25/-; F1, F2, F3, 25/-; G10, G11, G12, G13, 32/6; Colvern K21, K22, K23 superhet coils, 12/- set; Colverdynes, 7/- each; Radiopaks band pass superhet, 30/- each.

THE Above Post or Carriage Paid. PHONE: Clissold 5001.

OPEN All Day Thursday, closed on Saturdays. 24, Mildmay Grove, London, N.1. [6129]

PREMIER. PREMIER SUPPLY STORES Offer the Following Set Manufacturers' Surplus New Goods at a Fraction of the Original Cost; all goods guaranteed perfect, carriage paid over 5/-, under 5/- carriage forward, I.P.S. and abroad, carriage extra.

SPECIAL Offer of P.M. and Energised M.C. Speakers, from well-known gramophone manufacturer.

TYPE 10971G, 9in. diameter, 115 ohm field, 120-200 m.a., with power output transformer, handle 4 watts; 17/6.

TYPE 10971C, 9in. diameter, 2,000 ohm field, 40-70 m.a., Pentode transformer, handles 4 watts; 17/6.

TYPE 10955F, 9in. diameter, 11,650 ohm field, 20-30 m.a., auditorium type power transformer, handles 10 watts; 30/-.

TYPE 10955H, 9in. diameter, 115 ohm field, 350-400 m.a., auditorium type Pentode transformer, handles 10 watts; 30/-.

TYPE 4480B, 9in. diameter, permanent magnet, handles 4 watts, 7 ohms speech coil, 13/6; Multi ratio transformer, 4/6 extra.

(This advertisement continued in third column.)

BULGIN for the UNIVERSAL SINGLE-SPAN THE COMPLETE RANGE

of Bulgin Components is renowned for consistent quality and efficiency. For years they have been Specified and recommended by designers of "Wireless World" Receivers.

Required for the Single-Span.

Screened H.F. Choke. List No. H.F.8.

Power L.F. Choke. List No. L.F.15.

Valve-holders. 5 and 7-pin chassis mounting types.

Bulbs. 2 volt 0.06 amp. Type H.

Knobs with pointer. List No. K6.

5-Pin Plugs. List No. P3.

Resistances. A complete series for all Single-Span receivers.

Fixed Condensers. All capacities specified.

THERE'S SATISFACTION IN BUILDING WITH BULGIN GUARANTEED COMPONENTS

Full details of all the above components are given on pages 12-17, 18-21, 23, 28, 27, 51-53 of our 80-page Catalogue No. 153 "W."

Send for 80-page Catalogue No. 153 "W" Enclose 2d. postage.

NAME

ADDRESS

A. F. BULGIN & CO., LTD., Abbey Road, Barking, Essex London Showrooms: 9, 10, 11, Corsitor St., Chancery Lane, E.C.4

First and Foremost! CLIX

Specified for every one of the "Wireless World" SINGLE-SPAN RECEIVERS

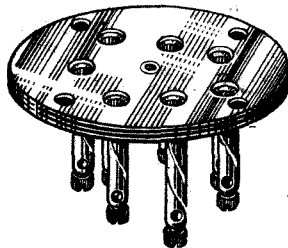

Clix Chassis Mounting VALVEHOLDERS 7-Pin... 1/- 5-Pin... 9d.

The "Wireless World" also specifies Clix latest perfect contact component.

THE CLIX VALVE CAP CONNECTOR

Five required for the Universal Single-Span Receiver.

Obtainable from all dealers.

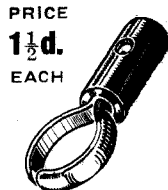

Lectro Linc Ltd., 79a, Rochester Row, London, S.W.1.

Components, Etc., for Sale.—Contd.

(This advertisement continued from first column.)

ELIMINATOR Kits, including transformer, choke, Westinghouse metal rectifier, T.C.C. condensers, resistances and diagram, 120v., 20 m.a., 20/-; trickle charger 8/- extra; 150v. 30 milliamps, with 4v. 2-4 amps C.T. L.T., 25/-; trickle charger 6/6 extra; 250v. 60 milliamps with 4v., 3-5 amps C.T. L.T., 30/-; 300v. 60 m.a. with 4v., 3-5 amps, 37/6; 200v. 100 m.a., 39/6.

PREMIER Chokes, 40 milliamps, 25 hys., 4/-; 65 milliamps, 30 hys., 5/6; 150 milliamps, 30 hys., 10/6; 60 milliamps, 80 hys., 2,500 ohms, 5/6; 25 milliamps, 20 hys., 2/9.

ALL Premier Guaranteed Mains Transformers have Engraved Terminal Strips, with terminal connections, input 200-250v., 40-100 cycles, all windings paper interleaved.

PREMIER H.T.7 Transformer, output 135v. 80 m.a. for voltage doubling, 8/6; 4v. 3-4a., C.T. L.T., 2/- extra; with Westinghouse rectifier giving 200v. 30 m.a., 17/6.

PREMIER H.T.8 and 9 Transformers, 250v., 60 m.a., and 300v. 60 m.a. rectified, with 4v. 3-5a. and 4v. 1-2a. C.T. L.T. and screened primary, 10/-; with Westinghouse rectifier, 18/6.

PREMIER H.T.10 Transformer, 200v. 100 m.a., rectified, with 4v. 3-5a. and 4v. 1-2a. C.T. L.T. and screened primary, 10/-; with Westinghouse rectifier, 19/6.

PREMIER Mains Transformers, output 250-250v. 60 m.a., 4v. 3-5a., 4v. 2-3a., 4v. 1-2a. (all C.T.), with screened primary; 10/-.

PREMIER Mains Transformers, output 350-0-350v. 90 m.a., 4v. 3-5a., 4v. 2-3a., 4v. 1-2a. (all C.T.), with screened primary; 10/-.

PREMIER Auto Transformers, 100-110/200-250v. or vice versa, 100-watt; 10/-.

SPECIAL Offer of Mains Transformers, manufactured by Phillips, input 100-120v. or 200-250v., output 180-0-180 volts 40 m.a., 4v. 1 amp., 4v. 3 amps., 4/6; 200-0-200v., 4v. 1a., 4v. 3a., 4/6.

WESTERN ELECTRIC Mains Transformers, 300-0-300v. 65 m.a., 4v. 1-2a., 4v. 2-3a., 8/6; 500-0-500v. 150 m.a., 4v. 3-5a., 4v. 2-3a., 4v. 1-2a., C.T., 4v. 1a. C.T., 19/6; 1,000-0-1,000v. 250 m.a., 4v. 3a. C.T., 49/6; 2,000-0-2,000v. 150 milliamps, 49/6.

PREMIER L.T. Charger Kits, consisting of Premier transformer and Westinghouse rectifier, input 200-250v. A.C., output 8v. 1/2 amp., 14/6; 8v. 1 amp., 17/6; 15v. 1 amp., 19/-; 6v. 2 amp., 27/6; 30v. 1 amp., 37/6, 2v. 1/2 amp., 11/-.

COLLARO Gramo. Unit, consisting of A.C. motor, 200-250v. high quality pick-up and volume control, 49/-; without volume control, 46/-.

B.T.H. Trussed Induction Type (A.C. only) Electric Gramophone Motors, 100-250v.; 30/- complete.

B.T.H. Gramophone Motors, 100-250 volts A.C. or D.C., specially recommended for D.C., complete; 30/-.

EDISON Bell Double Spring Gramophone Motors, complete with turn-table and all fittings, a really sound job; 15/-.

SPECIAL Offer of Wire Wound Resistances, 4 watts, any value up to 50,000 ohms, 1/-; 8 watts, any value up to 50,000 ohms, 1/6; 15 watts, any value up to 50,000 ohms, 2/-; 25 watts, any value up to 50,000 ohms, 2/6.

WIRE Wound Potentiometers, 15,000 ohms 1/6; 50,000 ohms, 2/-; 500,000 ohms, 3/-; 1,000 ohm wire wound semi variable resistances, carry 150 m.a., 2/-.

CENTRALAB Potentiometers, 50,000, 250,000, 5meg. any value, 2/-; 200 ohms, wire wound, 1/-.

POLAR Star, manufacturers' model, 3-gang condensers, fully screened, 7/6; with trimmers.

ORMOND All-brass 0.0005 Condensers, with knob dial, 2/-; with slow motion drive, 3/-.

AMERICAN Triple Gang 0.0005 Condensers, with trimmers, 4/11; Utility Bakelite 2-gang 0.0005 screened with uniknob trimmer, 3/6; Polar Bakelite condensers, complete with knob, 0.00015, 0.00035, 0.0003, 0.0005, 1/-.

ORMOND Condensers, 0.0005 2-gang semi-shielded, 2/6; brass vanes, with trimmers, 3/6.

MAGNAVOX D.C.152, 2,500 ohms, 17/6; D.C.154, 2,500 ohms, 12/6; D.C.152 Magna, 2,500 ohms, 37/6, all complete with humbucking coils; please state whether power or Pentode required; A.C. conversion kit for above types, 10/-; Magnavox P.M. 7in. cone, 18/6.

RELIABLE Canned Coils with Circuit, accurately matched, dual-range, 3/- per coil; ditto, iron cored, 5/6.

RELIABLE Intervalve Transformers, 2/-; multi ratio output transformers, 4/6; Amplion L.S. Units, 1/6.

WESTERN ELECTRIC Condensers, 250v. working, 1 m.f., 6d.; 2 m.f., 1/-; 4 m.f., 2/-; 400v. working, 1 m.f., 1/-; 2 m.f., 1/6.

T.C.C. Electrolytic Condensers, 550v. working, 650v. peak, 3 m.f., 4/-; 4 m.f. or 8 m.f., 440v. working, 3/-; 15 m.f. 50v. working, 1/-; 25v. working, 25 m.f., 1/3; 6 m.f. 50v. working and 2 m.f. 100v. working, 6d.

T.C.C. Condensers, 250v. working, 2 m.f., 1/9; 2 m.f. 1,500v. working, 6/-; 4 m.f. 1,500v. working, 10/-.

H.M.V. Condensers, 400v. working, 4x4x1x1x1x1x0.1 x0.1x0.1x0.1, 4/9; 4x2x1x1x1x0.5, 3/9.

VARLEY Constant Square Peak Coils, band pass type BP.7, brand new in maker's carton with instructions and diagram, 2/6.

VARLEY H.P. Intervalve Coils BP.8, band pass, complete with instructions in original cartons, 2/6.

SCREENED H.F. Chokes by One of the Largest Manufacturers in the Country; 1/9.

PREMIER British-made Meters, moving iron, flush mounting, accurate, 0-10, 0-15, 0-100, 0-250 m.a., 0-1, 0-5 amps.; all at 6/-.

LARGE Selection of Pedestal Table and Radiogram cabinets, by best manufacturers, at a fraction of original cost, for callers.

THE Following Lines 6d. each, or 5/- per dozen.— Chassis valve holders, 5-, 6-, or 7-pin, screened screen grid leads; any value 1-watt wire end resistances, wire end condensers, 0.0001 to 0.1 trimming condensers, Bulgin 3-amp. mains switches.

PLEASE Send for Fully Illustrated Catalogue.

PREMIER SUPPLY STORES, 20, High St., Clapham, S.W.4. Telephone: Macaulay 2188. Nearest Station. Clapham North Underground. 16010

GILBERT INDUSTRIES, Ltd.

PARCEL Containing 6 gross All Brass Screws, in useful B.A. wireless sizes such as 4 B.A. x 1in., 6 B.A. x 3/4in., etc., etc.; they include round, cheese and countersunk heads, and with every parcel we include 1 gross assorted nuts free, 5/-; post paid.

GILBERT INDUSTRIES, Ltd., 519, London Rd., West-cliff-on-Sea, Essex. [5997]

Components, Etc., for Sale.—Contd.

PEARL & PEARL.
DON'T Miss These Wonderful Bargains.
EKCO 1934 A.C. Eliminators, Model A.C.25, 25 m.a. output, input 200/250 volts, 40/100 cycles, variable S.G. tapping; variable 50/80 volt tapping; 120/150 volt tapping; list price £3/17/6; our price 35/-.
MODEL K.25 as A.C.25, but includes in addition an M.L.T. charger for 2.4-6-volt accumulators; list price £5/7/6; our price 45/-.
190, Bishopsgate, London, E.C.2. All the following bargains guaranteed new goods. Cash or C.O.D. Carriage paid.
TRIOTRON 4-pole Balanced Armature Speaker Units, type "B," sensitive, beautiful tone; list 22/6; our price 6/11.
POLAR 2-ganged Screened Condensers, with trimmers, pilot lamp holder, calibrated scale and escutcheon; list 27/6; our price 8/11.
LISSEN Pick-ups with Volume Control Incorporated; list 15/-; our price 6/11.
LISSEN Drum Dials, hair line tuning, fit all condensers, illuminated dials; our price 4/6.
SOVEREIGN Iron Cored Coils, with circuits, 2/11 each.
200 ONLY—Marconiphone 2 valve receivers with speaker and Marconi valves, in handsome oak cabinet; 28/11 carriage forward.
ALL Mail Orders Direct to Pearl & Pearl, 190, Bishopsgate, London, E.C.2. Telephone: Bishopsgate 1212 (3 lines). [0421]
SOUTHERN RADIO'S Bargains.—Set manufacturers' guaranteed surplus.
VARIABLE Condensers.—Lotus 3-gang 0.0005, 12/6; Lotus 2-gang, 0.0005, 8/6; Lotus Dyblock single, 0.0005, 4/9 (list 9/6); all these condensers are complete with dials escutcheons, knobs, fully screened with trimmers, and boxed; Hydra block condensers, 16 mid. (2+2+8+2+1+1) 1,000V. D.C., 7/- each; Dubilier 4 mid. (2+1+1), 1,000V. D.C., 2/9; 4.5 mid. (2.25+2.25), 1,000V., for mains noise suppression, 3/-; fixed 4 mid., 2/3; 2 mid., 1/6; 1 mid., 1/-; Utility Midget 2-gang variable condensers, 0.0005, with concentric trimmers, 3/5; T.C.C. 0.1+0.1, 1/3 each.
SPEAKERS—Blue Spot permanent magnet, with universal transformer for power, super power, pentode and Class B, 23/- (list 39/6).
G.E.C. Stork Speaker, in cabinet; 19/6 (list £3/15).
MICROPHONES—"Wonder," ready for use on any set; 3/9 each.
BLUE Spot Genuine 100U Inductor Speaker on Chassis; 15/6 (list 39/6).
ST.400 Kits, all specified proprietary components; £2/19/6 (list £4/17/6).
EKCO A.C. Eliminators, each new and boxed, in original sealed cartons, type K25, with trickle charger, 25 milliamps., 39/6 (list £5/7/6); type A.C. 25, 33/6 (list £3/17/6); type K.12, with trickle charger, 37/- (list £3/17/6); Ekco trickle chargers, type T.C.I., for 2-4- and 6-volt accumulators, 20/- (list 42/-).
IGRANIC Superhet. Coils, set of 4 (1 Osc., 2 I.F. with pig tails, 1 L.F. plain); 12/6 (list 50/-).
IGRANIC Band Pass 3 Coils Unit, iron-cored, screened on base, with switch; 14/- (list 33/-).
LISSEN Superhet, 3 Coils Unit, screened, ganged on base with wave change and filament switches; type L.N.5181, for battery or mains; 12/6 (list 30/-).
VARLEY Constant Square Peak Coils, complete with all accessories, new, boxed B.P.5; 2/4.
VARLEY H.F. Inter-valve Coils B.P.6, 2/3.
5-VALVE Class B Superhet. Chassis, made by Plessey, wired ready for use, with 5 Mullard valves, new, in sealed cartons; £3/17/6 complete (list £12/12); valves alone are priced £3.
FRAME Aerials.—Lewcos dual wave superhet., 9/- each (list 27/6).
PICK-UPS—Marconi No. 19 (1934), 22/6 each (list 32/6); Celestion latest improved type W8 (1934), 16/9 (list 35/-); all new and boxed.
READY Radio Instamat Transformers, for matching ratios: 1, 2:1, 3:1, 4:1, 7/6 (list 27/6); Senior model, ratios 1:1, 2:1, 3:1, 4:1, 16:1, 20:1, 25:1, 12/6 (list 37/6).
RECEIVERS—3-valve screen-grid Elector Super, complete with valves, Exide batteries and accumulator, Celestion moving coil speaker, contained in magnificent walnut cabinet; £3/10 (list £10).
OSRAM Thirty-Three Music Magnet, complete with G.E.C. speaker, two Osram screen-grid and Osram power valves in moulded bakelite-walnut cabinet; £3/12/6 (list £9/9); in original sealed cases.
READY Radio Meteor Screen-grid 3-valve Kits, all specified components new in sealed cartons; 25/-, less valves; with 3 Mullard valves 42/6 (list £5/7/6).
"A" Kit as Above, complete with magnificent walnut cabinet and Celestion perm. mag. speaker; less valves, £3/5; with 3 Mullard valves, £4/2/6 (list £8/17/6).
MAINS Transformers.—Full list of mains transformers and chokes sent free.
MISCELLANEOUS—Rotorohm volume controls, all valves, 3/- each, with switch, 3/3 (list 10/6); Hellesen's 8 mid. electrolytic condensers, 2/9 each; Westinghouse metal rectifiers, H.T. 6, 7, 8, 9/3 each; Ferranti chokes, 20 Henry 60 m.a., 6/9 each; Ready Radio L.F. transformers, 5-1, 3-1, 3/3 (list 8/6); Lewcos superhet., 8-way bases, complete with valve holders, grid leak, fixed condenser type "48", 2/- each; Lissen base turntables, 1/6 (list 5/-); Lissen H.F. chokes, 1/6 (list 5/-); Lewcos coils, B.P.F./R., 4/-; T.B.F./C., 3/3; O.S.C./126 (Extensor), 3/3; T.O.S./R., 3/3.
ALL Goods Guaranteed and Sent Carriage Paid; hundreds of other bargains in stock.
BRANCHES at 271-275, High Rd., Willesden Green, N.W.10, and at 46, Lisle St., W.C.2. Please send all post orders to 323, Euston Rd., N.W.1.
SOUTHERN RADIO, 323, Euston Rd., London, N.W.1 (near Warren St. Tube). 'Phone: Museum 6324. [6134]
£8—Amplifier, A.C.H.L. transformer, coupled D. O. 25/- push-pull self-contained speaker, leaflet; parts microphone amplifier, including H.F. Pentode, Mullards circuit, £1; brand new P.M. speaker unit and exponential horn, complete, £5; unit itself costs £6/6.—Bradford, Entertainer, Whitechurch, Bristol. [6141]

Components, Etc., for Sale.—Contd.

WOBBURN RADIO Offer Following New Purchase:—
WESTERN Electric Microphones, brand new and boxed, listed at 18 6 each, super sensitive, 2/6 each; transformer, ratio 85/1, for use with same, 2/3.
W.R.C. Eliminators, four models: 150v. output at 30 m.a., D.C. model, 9/9; Universal, A.C./D.C., 21/-; A.C., 21/-; A.C. with trickle charger (2v. 1/2 amp.), 32/6; all types 5 positive H.T. tappings; all guaranteed 12 months.
TRADE Enquiries Invited; new list now ready.
WOBBURN RADIO Co., 9, Sandland St., W.C.1. Holborn 7289. [6132]
MAINS RADIO DEVELOPMENT COMPANY'S Surplus Bargains.
SPACHEITUS Ready-Radio, boxed, brand new, 10,000, 15,000, 20,000, 25,000 ohms, Mikado 0.0005, 0.002 fixed condensers, any assortment; 9d. per 12.
UTILITY 0.0005, 0.0003 Bakelite Reactions, 8d.; Plessey 5-pin. V-holders, 1/- per 6.
BROWN'S 5-1, 3-1 L.F. Transformers, new, 2/6; T.C.C. 0.1x0.1 mid. condensers, 450v. working, 10d.
SATOR 2-meg. Leaks, 0.0001, 0.0003, tubular condensers, all new, wire ended; 1/- per 6.
BULGIN On off Toggles, 6d.; new standard Systoflex, 12 feet ed.; any component applied; quote and list by return; trade supplied.
MAINS RADIO DEVELOPMENT COMPANY, 4-6, Muswell Hill Rd., London, N.6. Tudor 4046. [6104]
THE Following Unused Set Manufacturers' Surplus, all goods guaranteed perfect, immediate delivery.
FERROCART Coils, G1, G2, G3, with switch, 27/6; G11, G12, G13, G14, with switch, 33/6; Colverdynes, 7/1, 7/2, 7/3, 7/4, 7/5, 7/6, all types, 35/-.
DUBILIER Resistors, 1 watt type, 7d.; 2 watt type, 1/3; Marconi K19 pick-ups, 22/6.
WESTINGHOUSE Rectifiers, H.T.8, 9/6; H.T.9, H.T.10, L.T.4, L.T.5, 10/9; transformers (Regentone) for H.T.8 or H.T.9, with 4 amp. L.T., 7/6.
TRANSFORMERS, 350-0.350V. 60 m.a., 4v. 4a., 4v. 2a., 12/6; A.C. and D.C. eliminators, first-class make, tappings, S.G. detector, power (150v. 25 m.a.), A.C. type with Westinghouse rectifier, 25/-; D.C. type, 12/-.
DUBILIER or T.C.C. Electrolytic Condensers, 8 mid. or 4 mid., 500v., 50v. 50 mid., 3/6; B.T.H. pick-up tone arms, 3/-.
CARRIAGE Paid, cash with order or c.o.d.; send for list.
WARD, 2nd Floor, 45, Farringdon St., London, E.C.4. Telephone: Holborn 9703. [5724]
UTILITY SALES Co. Offer the Following Surplus Goods, all new and boxed and fully guaranteed:—
CELESTION P.M.M.W. Speaker; list 45/-, 17/6.
EKCO 1/2 amp. 2.4-6-volt L.T. Charger, list £2/7/6, 17/6; also A.C. 25, 31/6; K.25, 33/6.
MAINS Transformers by Standard Cable Co., primary 200-240, secondary 300-0.300, 60 m.a., 4v. 3a. ct., 4v. 2a., very strongly recommended; 6/6.
ALL Our Goods are Delivered Within 24 Hours—carriage paid.
UTILITY SALES Co., 27a, Sale St., Paddington, London, W.2. [6121]
BIRMINGHAM RADIOMART Revised List Now Ready; more components than advised in whole these columns; stamp essential.
RADIOMART—Utility fully screened 3-gang, with 3 trimmers, list 22/-, almost identical Radiophone; 6/6.
RADIOMART—Igranite smoothing chokes, 20-10h., 260 ohms, 100 m.a. Stalloy core impregnated interleaved windings; 2/9.
RADIOMART—Single span formers, 1in.x2in., 7 for 10d.; 100 m-mid. micros., 1/3.
RADIOMART—Radiophone straight line dials, illuminated, ours have oxidised escutcheons, knob; 3/6.
RADIOMART—Igranite boxed nickelcore 3-1, 5-1 transformers, list 10/6, 3/11; Igranite 8/6 parallel feed, 2/11.
RADIOMART—Screened Caradio ignition cable, ideal screened downward; list 4/6, 9d. yard.
RADIOMART—3 1/2 in. flush 4/3 moving coil milliammeters, completely reconditioned Air Force, 10, 25, 50, 100 m.a.; 16/6.
RADIOMART—Visual tuning meters, extremely neat, 5/9; 50 ohm potentiometer, for humdumming, 8d.
RADIOMART—Sovereign 50,000 genuine wirewound potentiometers, 5-watt, heavy current, 2/-; Electrad 50,000 potentiometers, 1/6.
RADIOMART—Boxed Telsen 500v. electrolytics, 6 R mid., 2/9; 4 mid., 2/7; 275v. 6 mid., 2/-; Dubilier 4 mid., 200v., 1/3; all dry.
RADIOMART—T.C.C. 250v. A.C., equivalent 400v. D.C. working, 4x4x4 (12 mid.), 3/9; T.C.C. 8 mid. electrolytics, 3/-.
RADIOMART—Aerovox 8x8 mid. dry, the world's best electrolytic; 3/6; cheapest smoothing possible.
RADIOMART—Non-inductive wire-ended tubulars, 1,500v., 0.1 0.01, 0.02, 6d.; Philips ditto, 0.0001, 0.001, 2d.
RADIOMART—Igranite Igranicores chassimount dual range coils, 3/6; Igranite 400 ohms potentiometers, 6d.
RADIOMART—Utility 1934 bakelite tuning and reaction condensers, 0.0005, 10d.; 0.0003, 8d.; 0.0002, 0.0001, 6d.; 0.0003 differentials, 1/6.
RADIOMART—Cadmium 5-valve chassis, 1/6; 4-valve chassis, 1/-; postage 6d. extra.
RADIOMART—Utility W312B screened 2-gang 0.0005 super bakelite, fitted Uniknob trimming disc drive; 2/11.
RADIOMART—Telsen boxed differential condenser with knob, 0.0001, 0.00015, 1/-; 0.0003, 0.00035, 1/3.
RADIOMART—Met-Vic boxed H.F. chokes, really efficient, 1/-; Utility snap switches, 9d.
RADIOMART—Colvern 5-watt wirewound potentiometers, 2,500, 15,000, 1/6; Magnum, 25,000, 1/9.
RADIOMART (G5NI), shortwave specialists, actually stock Hammarlund "Comet Pros," McMurdo single signal, National F.B.7.
RADIOMART—Igranite incore dualrange shortwave coils, 3/3; with switch, 4/9; Raymart shortwave H.F.C., 9d.
RADIOMART—Famous 0.0001 all brass shortwave variables, 1/9; Ormond 0.00025 loloss pigtail, 1/9.
RADIOMART—Western Electric solidback guinea microphones, 2/9; Beehive standoff insulators, 8d.; Frequentite valveholders, 9d.
RADIOMART—Orders over 6/-, post free.—The Square Dealers, 18, John Bright St., Birmingham. [6135]
OSRAM Photo Cells C.M.G.8, used test, 35/-; B.T.H. senior pick-ups, 17/6; Ferranti A.F.5.C., 15/-; Thomas, 17, Vivian St., Abertillery, Mon. [6124]

Components, Etc., for Sale.—Contd.

25 Only Special Class B Kits, comprising P.M. speaker, Multitone driver, Class B valve and holder, cost £2/17/6, to clear; 30/4.
MANY Other Bargains in Pepper's New Sales List, now available.
PEPPER, 575, Moseley Rd., Birmingham, 12. [6092]
Vauxhall—Radiophone, Radiopaks, complete with volume control and Lucerne station named scale and escutcheon, state type, 32/6; intermediate transformers for above, with terminals, 6/-; coils set of 3 on base with switch and terminal, 16/5; 3-gang condensers, super-het., 14/6; ordinary type, 12/6; disc drives, complete, 4/9.
Vauxhall—Pick-ups from 8/- to £2; state make for quotation; volume controls, all values, with switch and knob, 3/6; gramophone switches, 3/6.
Vauxhall—Benjamin, Class B, transformers, 1-1 1/2 to 1, 6/6; Radiophone, Class B, 10/-; L.F. transformers, 3/-.
Vauxhall—Resistors: Dubilier, 1-watt, 7d.; tubular condensers, all values, from 4d.; Clix valveholders, 4.5 P.M. terminal, 7d.; 7-pin chassis type, 7d.; W.B. ditto, 4.5 pin 4/2.
FREE Service.—Home constructors' queries; write details fully; send postcard for lists.
Vauxhall UTILITIES, 163a, Strand, W.C.2 (facing Bush House, S.E. Wing). Temple Bar 9338. [6137]
PICK-UPS: Bowyer-Lowe Mark III and IV, Rothermel Piezo, electric; speakers: Magna single and dual, Hartley Turner, Rothermel Brush R.95 and R.105, A.P.5c, A.P.5c, Wearite, Nicore 110 kcs. intermediates, Varley Monofonic coils, Wearite Filter 3,500, Erie resistors, T.C.C. condensers; others wanted; keen experimenter leaving town; must sell.—Shaw, 35, Joseph St. West, Darwen, Lancs. [6142]
DEGALLIER'S Offer Retailer's Bankrupt Stock.—Sealed retail cartons, 1934 eliminators, Ekco K.12, 150 volts, 12 m.a. sets, 1.3 valves, incorporating trickle charger, list £3/19/6, at 36/-; Type A.C.25, 150 volts, 25 m.a., 4 tappings, 2 variable, list £3/17/6, at 33/-; Type K.25, as in A.C. 25, but incorporating trickle charger, list £5/7/6, at 39/6; Type T.C.I., trickle charger, 2 to 6 volts, list £2/2, at 19/6.
AUTOMATIC Record Changers.—A.C. Garrard (6 only), complete with pick-up, etc., list £10, at £7/10; crate 5/- (returnable) extra; (4 only) H.M.V. playing desks, walnut, incorporating changer, pick-up, volume control, etc., £9, crate extra 10/- (returnable).
PICK-UPS—1934 Marconiphone, Type 19, list 32/6, at 22/6; B.T.H. Senior De Luxe, list 37/6, at 28/-; Celestion W.8, list 35/-, at 17/-.
WESTINGHOUSE Metal Rectifiers, H.T.6, 7, 8, 9, and L.T.2 and 3, 9/3 each; H.T.10 and L.T.5, 10/5 each; all above carriage paid; cash with order or c.o.d.—Degallier's, 4/21, Upper Marylebone St., London, W.1. [6131]
PIONEER RADIO Offers Ericsson 3-1 L.F. Transformers, list price 17/6, new and guaranteed; our price 2/3, post free U.K.; Varley Constant Square Peak Band-Pass Coils, type B.P.5, complete with switch, brand new, in maker's original carton, with full instructions and diagrams, list price 15/-; our price 2/4, post free U.K.; Polar 3-gang Star Minor Condensers with trimmer, brand new, list price 18/9, our price 7/- each, post free U.K.; Collaro Electric Gramo. Motor, A.C., 200-250, with pick-up and volume control, auto start and stop, brand new, listed at £4, our price 47/6, carriage paid; Celestion Energised M.C. Speaker, 2,500 ohms, model D.C. 2054, with universal transformer, list price £2/5, our price 12/6; bankrupt set manufacturers' stock.
PIONEER RADIO, Coptic St., London, W.C.1. Museum 9606. [0425]
MISCELLANEOUS.
EVERYTHING for Movies.—Cameras and Projectors from 20/-; screens from 5/-.
ILLUSTRATED ENTERPRISES, 159, Wardour St., London, W.1 (facing Film House, Oxford St. end); not a shop, but a warehouse packed with motion-picture equipment; your inspection invited. 'Phone: 6889 Gerrard; free parking facilities. [5936]
EMPLOYERS are Searching for Skilled Draughtsmen and First Class Engineers, all branches; our special postal training will make you suitable.—Dept. 92, The Bennett College, Ltd., Sheffield. [6068]
GUARANTEED Expert Repairs to Any Receiver, estimate free, highest quality workmanship, lowest prices; receivers taken in part exchange.—Zenith Radio Service, 17, Park St., Guildford 'Phone: 1700. [0423]
AMBITIOUS Men.—Qualify for a well paid post by studying at home with the T.L.G.B. Write to-day for "The Engineer's Guide to Success," 152 pages, free, which contains the widest selection of engineering and wireless courses in the world, and shows you how to become A.M.I.E.E., A.M.I.Mech.E., A.Rad.A., etc. State branch, post or qualification that interests you.—The Technological Institute of Great Britain, 82, Temple Bar House, London, E.C.4. (Founded 1917. 19,000 successes.) [6029]
PATENT AND TRADE MARK AGENTS.
A. MATHISEN, Chartered Patent Agent; patents, designs and trade marks.—First Avenue House, 524 Holborn, London, W.C.1. Holborn 8950. [5284]
GEE and Co. (H. T. P. Gee, Patent Agent for Great Britain, U.S.A., Canada, etc., Mem. R.S.G.B. A.M.I.R.E.), 51-52, Chancery Lane, London, W.C.2 (2 doors from Government Patent Office). 'Phone: Holborn 1325. Handbook free. [0001]
REPAIRS.
METROPOLITAN RADIO SERVICE Co., for car radio, installation and service.
REPAIRS to all British and American Receivers, American valves (all midget types), transformers, re-wound.—Metropolitan Radio Service Co., 1021, Finchley Rd., Golders Green, London, Speedwell 3000. [0435]
ANY Set, from a 1-valve to a 9-valve American, put in perfect order; car sets a speciality; we are experts.—Universal Radio, 219-221, City Rd. E.C. [6145]
MAINS Transformers Rewound; prompt service; satisfaction guaranteed; prices on request.—The Sturdy Electric Co., Wesley Terrace, Dipton, Newcastle-on-Tyne. [5992]

Repairs.—Contd.

AMERICAN and British Receivers, amplifiers, etc., repaired, transformers rewound.—Radio Service and Supplies, 317, High Rd., Wood Green, N.22. Bowes Park 2419. [6139]

HENRY FORD RADIO, leading service specialists for American receivers, also British, trade work particularly; estimates free.—56, Howland St., Tottenham Court Rd., W.1. Museum 5675. [0434]

OLD Sets Transformed to All Mains Universal A.C.—D.C. with New High Voltage Valves, powerful, clear, hum-free reception guaranteed; prices 10/- per socket, plus price of valves; no extra parts charged for.—Sablon's Radio, 69, Sister's Ave., London, S.W.11. [5837]

REPAIRS to Moving Coil Speakers, cones and coils fitted or rewound. Eliminators and transformers quoted for. Loud-speakers, l.f. and speech transformers, 4/- each. Post free. Trade invited. Satisfaction guaranteed. Prompt service.—Loud-speaker Repair Works, 5, Balham Grove, London, S.W.12. Battersea 1321. [0394]

TUITION.

YOUTHS Trained for all branches wireless profession. Britain's leading college. Training fee payable after appointment. Students boarded. London representative for interviews. Prospectus free.—Wireless College, Colwyn Bay. [0388]

ELECTRIC CLOCKS.

SPECIAL Offer.—Superior A.C. main electric clock movements, 200-250v. 50 cycles, drive up to 10-inch hands; 16/6, post 6d.—Write details, Ebury Bridge Radio Co., 33, Ebury Bridge Rd. Sloane 8407. [5963]

EXCHANGE.

DEAL With the Firm that Gives You the Highest Possible Allowance in Exchange, sets or components; prompt attention and deliveries.—Mildmay Radio Exchange, Phone Clissold 5001. 24, Mildmay Grove, London, N.1. [5985]

EXTENDED PAYMENTS.

EASY PAYMENTS.—We supply you direct, by easy payments, components, accessories, and sets, any make; 10% down, balance spread over 11 months; any radio goods ordered c.o.d. despatched same day.—Send list of requirements to London Radio Supply Co. (established 1925), 11, Oat Lane, London, E.C.2. [0337]

FINANCIAL PARTNERSHIPS.

SMART Man Required as Sales Director, with car to travel and establish connection; investment about £200.—Box 982, c/o *The Wireless World*. [6111]

WANTED.

GOOD But Cheap Electric Set, A.C. 200-250.—Box 990, c/o *The Wireless World*. [6128]

SPOT Cash for New or Used Modern Components.—Economic Radio Co., 96-98, South Lambeth Rd., S.W.8. [5964]

WANTED, A.C. chassis, in exchange for Climax B.P.III chassis, D.C. mains, as new.—97, Watford Rd., Wembley. [6125]

ALL Types of Amplifiers, cinema, public address and television equipment, speakers, valves, etc., bought for cash.—Universal Radio, 219-221, City Rd., E.C.1. [6144]

WANTED, good modern second-hand wireless parts, sets, meters, eliminators, speakers; we pay higher prices than any other dealer; bring or send, spot cash. Open 9-8.—University Radio, 142, Drummond St., Euston, N.W.1. [6119]

HIGH-CLASS Radio Parts and Sets Wanted for Cash, new or second-hand, any quantity, we pay up to one-third of the retail value for class goods; send yours, stating reasonable price; cash by return (no junk, please); dealers' obsolete stocks also purchased, any amount; van and representative will call for any reasonable lots.—Mildmay Radio Exchange, 24, Mildmay Grove, London, N.1. Phone Clissold 5001. [5984]

SITUATIONS VACANT.

AIR MINISTRY. Directorate of Technical Development. **A**SSISTANT II Required, to assist in the design and development of high grade wireless receivers for use in aircraft.

CANDIDATES should have had training to the standard of the Science or Electrical Engineering Degree and considerable experience in connection with the design and development of apparatus for wireless telegraphy and telephony.

CANDIDATES must be physically fit for flying and be willing to fly as observers.

COMMENCING Salary £305/19 per annum, rising by annual increments for approved service to £376/6 per annum; this rate is liable to review.

PREFERENCE Given, other things being equal, to ex-Service men.

APPPLICATION should be made on a form to be obtained (quoting reference No. A.605) from the Chief Superintendent, Royal Aircraft Establishment, South Farnborough, Hants, to whom it should be returned not later than 30th July, 1934. [6106]

RADIO Testers Required, with experience of chassis testing on modern receivers.—E. K. Cole, Ltd., Ekco Works, Southend-on-Sea. [6108]

MANUFACTURERS Require Agents in all Districts, for sale of highly successful receivers.—Box 983, c/o *The Wireless World*. [6112]

DEVELOPMENT Engineer, thoroughly capable of developing modern receivers up to production; excellent opportunities.—Box 978, c/o *The Wireless World*. [6109]

ASSEMBLY and Testing; thoroughly competent and capable engineer required to control the assembly and output of simple receivers; good opportunity for progress.—Box 979, c/o *The Wireless World*. [6110]

ENGINEER, Required for Valve Factory, East London; must have had thorough practical experience in modern valve manufacture.—Apply, stating age and experience to Box 981, c/o *The Wireless World*. [6117]

GLASS Worker Required, used to good class bench work, for scientific and large radio valve manufacture.—Apply, with full particulars, to Box 980, c/o *The Wireless World*. [6116]

APOLOGY

As the VOIGT Stand at Olympia will be NEXT TO THE B.B.C. AMPLIFIER we may have to suspend demonstrations while the engineers are checking. Apologies are tendered in advance to any visitors who, desiring a demonstration of the Voigt Domestic Speaker with encased horn, may be asked: "To call again later."

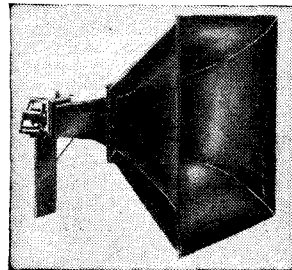

Natural

PUBLIC ADDRESS

If you are interested in natural quality write for details of the Voigt Speaker, or discuss your problems with us at Olympia. Remember: our Stand is next to the B.B.C. Amplifier.

A FEW LOUDSPEAKERS AVAILABLE FOR HIRE BY ARRANGEMENT.

VOIGT PATENTS LTD.

THE COURTS, SILVERDALE, LONDON, S.E.26
Tel.: Sydenham 4114



VOIGT PATENTS LTD Reg. Office: 22, Castle St., E.C.1

LIQUIDATOR'S SURPLUS STOCK

- A.C./D.C. Superhet Chassis, Westector A.V.C., with Westinghouse Rectifier, £4.
- D.C. Radiogram, Walnut Veneer Cabinet, £6 10s.
- D.C. Radiogram, very powerful, £7 10s.
- A.C. Radiogram, modernistic Cabinet, 4-valve, £10 17s. 6d.
- A.C. R.A.P. Superhet, with Garrard Automatic Record Changer, £15.
- Battery 3-Valve Kits, with Cabinet, 12s. 6d.
- B.T.H. Push-Pull Amplifier, with B.V.A. Valves, £6 10s.
- 31-Watt Amplifiers, with B.V.A. Valves and Speaker, £8 10s.
- Motor P.M. Speakers, with heavy Darwin cobalt Magnet, 16s.
- Rotary Converter, Makers, Croydon Engineering, with Smoothing, complete in soundproof metal Cabinet, £6 10s.
- Ultrax Microphones, now in beautiful Bakelite surround, as reviewed "W.W." 12s. 6d.; De luxe, 15s.
- Chassis, fitted valve holders, complete with 4 B.V.A. Valves, S.G. Det. Pen. Rect., £1 10s.
- R. & A. Balanced pairs of energised Speakers, all fields, £1
- Regentone all power A.C. Eliminator, W.L.A., £2.
- Regentone, Model W.L.B., £1 5. Ekco, D.C., 19s. 6d.
- Marconi 5-Valve Chassis, PX4 output, complete with Valves, £3.
- Philips Double Mains Chokes, 5s.
- Various Mains Transformers, from 3s. each.
- Ekco All-Power D.C. Unit, £2.
- S.G. Brown 3 V. S.G. Set, with Valves, £1 7s. 6d.
- Ferranti Push-Pull Input and Output Transformers, pair £1.
- Ferranti Trans. and Chokes, from 5s.

UNIVERSAL RADIO, 219-221, CITY ROAD, E.C.1.

Phone: Clerkenwell 0719.

Wherever Moving Coil Speakers are Praised and Admired, the Name



IS ON THE TIP OF THE TONGUE, RECOMMENDED AND SOLD BY DEALERS EVERYWHERE

BAKER SELHURST RADIO LTD., SUSSEX ROAD, CROYDON

SAVAGE

MAINS TRANSFORMERS

56/58, CLERKENWELL ROAD, E.C.1

Phone: Clerkenwell 3068/9.

SITUATIONS WANTED.

SERVICE Engineer Desires Position with Firm of Repute where long practical experience, sound theoretical knowledge, familiarity with modern receiver design, and ability to handle all types of client with tact and understanding, are likely to be of use.—Box 992, c/o *The Wireless World*. [6127]

BOOKS, INSTRUCTION, ETC.

10 Vols. "Wireless World," Nos. XXV to XXXIV.—Johnson, Gas Works Cottage, Thaxted, Essex. [6140]

AUCTION SALES.

WITHOUT RESERVE. By order of the Receiver and Manager, L. Gilbert, Esq., re Yagerphone, Ltd. (in Liquidation), and others. **PONDERS END, MIDDLESEX.**
MESSRS. JOSEPH HIBBARD & SONS will Sell by Public Auction upon the premises, in Lea Valley Road, close to Ponders End Station (L. & N.E. Ry.), on **TUESDAY, JULY 24th, 1934, at 1 o'clock,** **STOCK AND PLANT OF RADIO MANUFACTURERS,** including 1,300 RADIOGRAM, RADIO, GRAMOPHONE CABINETS in Oak Walnut and Mahogany, comprising Pedestals, Consoles, Sideboards, etc. 1,000 RADIO and GRAMOPHONE TABLE CABINETS, WIRELESS SETS, RADIO GRAMOPHONES and GRAMOPHONES PARTLY FITTED, SPEAKER CABINETS, LARGE QUANTITY of STORES of WIRELESS and GRAMOPHONE COMPONENTS.

PLANT, including:— Valve-making Equipment, Spraying Cabinets, Coil Winders, Bakelite Press and Moulds, 5ft. and 1 3ft. Dimension Saw Benches by Ransome, 30in. Panel Planing Machine, 3 Dovetailing Machines, Automatic Hack Saw, 2 Metal Guillotines, Emery Grinder, Metal Rolling Machines, 4 Vertical Drilling Machines, Palmers Cramps, Electric Motors, Shafting, and Office Furniture.

On view day prior to sale and sale morning. Catalogues can be obtained from L. Gilbert, Esq., 306-308, Euston Road, N.W.1 or from the Auctioneers' Offices at 15, NEWINGTON GREEN ISLINGTON, LONDON, N.16

AMERICAN TYPE VALVES

Philco Valves — all with a definite guarantee — are suitable for all American makes of radio sets.

Philco Type 80—Full Wave rectifier 350 volts, 125 m/a —Price 8/- 6A7, 2A7 and 1A6 Heptodes at 16/-

● Write for Full Price List or for price of special type required giving the maker's type number.



● The Philco Radio and Television Corporation of Gt. Britain Ltd., Valve Dept., Perivale, Middlesex. Phone: Perivale 3344

INDEX TO ADVERTISEMENTS.

PAGE		PAGE		PAGE
	Automatic Coil Winder & Electrical Equipment Co., Ltd. Inside Front Cover		Ferranti, Ltd.	
	Baker "Selhurst" Radio 5		Gramophone Co., Ltd.	
	Belling & Lee, Ltd.	2	Hartley Turner Radio, Ltd.	
	Benjamin Electric, Ltd. Back Cover		Heayberd, F. C., & Co.	
	Black, Alexander, Ltd.	3	Lectro Linx, Ltd.	
	British Institute of Eng. Technology		Milnes Radio Co., Ltd.	
	British Insulated Cables, Ltd. Inside Back Cover		Neill, James, & Co. (Sheffield), Ltd.	
	British Thomson-Houston Co., Ltd.	6	Ostar-Ganz (Eugen J. Forbat)	
	Bulgin, A. F., & Co., Ltd. 3		Pepper, Trevor	1
	Columbia Graphophone Co., Ltd.		Peto-Scott Co., Ltd.	5
	Cranley Radio, Ltd.		Philco Radio Corporation, Ltd.	iii.
	Dubilier Condenser Co. (1925), Ltd. Front Cover		Players	
	Earl Manufacturing Co., Ltd.		Radio Gramophone Development Co., Ltd.	
	Edison Swan Electric Co., Ltd.	2	R.I., Ltd.	
	Electradix Radios	1	Rich & Bundy, Ltd.	
	Fel-Ectric Radio		Rotax, Ltd. (M-L Equipment) Front Cover	
			Rothermel, R. A., Ltd. 6	
			Savage, W. Bryan 5	
			Sound Sales, Ltd.	
			Stratton & Co., Ltd.	
			Tannoy Products 1	
			Telegraph Condenser Co., Ltd. Inside Front Cover	
			Telephone Manufacturing Co., Ltd. Inside Back Cover	
			Telsen Electric Co., Ltd. Front Cover	
			Universal High Voltage Radio, Ltd. 6	
			Universal Radio Co. 5	
			Varley (Oliver Pell Control, Ltd.) Inside Front Cover	
			Voigt Patents, Ltd. 5	
			Westinghouse Brake & Saxby Signal Co., Ltd. Inside Back Cover	
			Whiteley Electrical Radip Co., Ltd. Front Cover	
			Wright & Weaire, Ltd.	
			362 Radio Valve Co., Ltd.	

OSTAR-GANZ UNIVERSAL

Build up your universal Single Span with Ostar valves, which are cheaper, more economical in consumption, simpler (the set and power pack in one unit), and results are perfect.

Free technical advice available. Valves used in the Ostar-Ganz universal Single Span are as follows:

1st detector and frequency changer.. G.5	19/9	2nd detector and A.V.C. Westector.	
Buffer valve M.S18	18/9	Output..... K3560 (4 watts R.M.S.)	25/6
2nd I.F. V.3	19/9	Rectifier EG100 120 mA.	14/9

No transformers, no barretters, no cut-down resistances required.

E. J. FORBAT, 28/29, Southampton St., Strand, W.C.2. Phone: Temple Bar 8608

WE CLAIM THAT

our Universal AC/DC sets fitted with the latest type Ostar-Ganz Universal High Voltage Valves are the most up-to-date receivers on the markets.

ALL-WAVES-ALL-MAINS-ALL-ELECTRIC Receivers and Amplifiers.

Our Receivers also supplied in CHASSIS form, thus making it possible to fit into your own cabinet and use your own speaker.

Also at little cost **WE UNDERTAKE TO CONVERT** any type and any make of set to a most up-to-date and Powerful All-Mains Receiver with the famous Ostar-Ganz Universal High Voltage Valves.

For full details and terms apply to: **Temple Bar 4985 UNIVERSAL HIGH VOLTAGE RADIO Ltd., 28-29, Southampton St., Strand, London, W.C.2**

Acknowledged and Acclaimed as the World's Finest Pick-up



The ROTHERMEL-BRUSH PIEZO-ELECTRIC PICK-UP

"The Wireless World" in its issue of May 11th comments upon the remarkably high sensitivity, free needle movement and negligible record wear achieved by this outstanding Pick-up. Once again Rothermel has given the radio industry something new and infinitely better than it has ever possessed before. The Piezo-Electric Pick-up ensures realistic reproduction, and a frequency response hitherto unobtainable, without wear and tear on your records. Used in conjunction with a Rothermel-Brush Piezo-Electric speaker combination it provides the most perfect musical reproduction it is possible to secure.

MODEL S.8. PRICE £2.2.0.

R.A. Rothermel LTD.
Rothermel House,
CANTERBURY ROAD, HIGH ROAD,
KILBURN, LONDON, N.W.6.
Phone: Maida Vale 6066.



Write for complete literature covering Rothermel-Brush Piezo-Electric Speakers, Pick-ups and Microphones.

The **ELEMENTARY PRINCIPLES**
of **WIRELESS TELEGRAPHY**
and **TELEPHONY**

by **R. D. BANGAY**

Third Edition
Revised by
O. F. BROWN, B.Sc.

THE standard book of instruction for wireless beginners and students. This revised edition brings the whole subject into line with modern developments in wireless. The style is clear and simple and attention is given to the theoretical elements of electricity and magnetism: to the dynamo; and to the properties of waves. A leaflet which gives full particulars of the volume, including a synopsis of the chapters, will be sent on request.

P R I C E
7/6 net, by post 8/-

From all leading Booksellers or direct from the Publishers
ILIFFE & SONS LIMITED
DORSET HOUSE, STAMFORD STREET, LONDON, S.E.1

w.w.97

B.I. RESINKOR SOLDER AND CORALINE PASTE

are two aids to efficient soldering. B.I. "Resinkor" Solder is a solder with just the right quantity of resin embedded in it. It is invaluable for the soldering of electrical connections, particularly on fine work. "Resinkor" can be supplied in coils, on reels, or in cut lengths as required, in all diameters down to 20 s.w.g. B.I. Coraline Soldering Paste is suitable for copper, brass, tin, iron and lead and for electrical connections except the jointing of paper insulated cables. It is quite easy to apply, even in the most awkward corners, and once having been applied it does not run off the work, nor does it dry. It gives off no spray and is very economical.

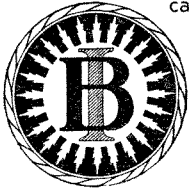

Supplied in 1-oz., 2-oz., ¼-lb., ½-lb., 1-lb. and 7-lb. tins.

BRITISH INSULATED CABLES LTD.

Cable Makers and Electrical Engineers

PRESCOT, LANCS.

Telephone No. PRESCOT 6571.

London Office: **SURREY HOUSE, EMBANKMENT, W.C.2**

Telephone No. Temple Bar 4793, 4, 5 & 6.

CONSISTENCY



Corn and Condensers — what a curious combination! Yet, just as corn is a living symbol that nature never fails man — so the T.M.C. HYDRA mark on a condenser is a warrant of consistent good performance. This unfailing consistency is only possible because T.M.C. HYDRA condensers are made from the finest raw materials, with up-to-date plant under the strictest scientific control, to tolerance figures of the narrowest margin.

Take advantage of these new standards in condenser production. Equip your set with T.M.C. HYDRA condensers—it will be

better for your set and better for your pocket. They are made in all standard capacities.

Write to the Distributors if you have any difficulty in obtaining supplies.

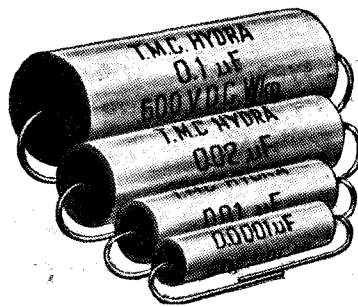

T.M.C

BRITISH MADE

HYDRA CONDENSERS

Price List from Distributors:

T.M.C.-HARWELL (SALES) LTD

Note New Address:

Britannia House, 233, Shaftesbury Avenue,

(A few doors from New Oxford St.) **London, W.C.2.**

Telephone: Temple Bar 0055 (3 lines).

Made by TELEPHONE MANUFACTURING Co. Ltd



Wherever there are A.C. Mains, there you will find Westinghouse Metal Rectifiers in use. Adopted by set manufacturers and constructors everywhere . . . specified again and again. Why? Because they are *reliable*. 60,000 hours' use at full load, and *no falling off in output*. No other rectifier can show even the smallest approach to such a record.

THE WESTINGHOUSE BRAKE & SAXBY SIGNAL CO., LTD.,
82, YORK ROAD, KING'S CROSS, LONDON, N.1.

You can get it!



DOUBLE SIX
LOUDSPEAKER

GOOD news travels fast as is evident by the large number of enquiries we have received since our first announcement of the coming "DOUBLE SIX."

It is here now and you can get it, but meanwhile here are a few interesting details:—

CONE DIAMETER—11 inches.

FREQUENCY RANGE—40 to 9,000 cycles.

REMARKABLE SENSITIVITY—With an ordinary set capable of delivering 2 watts undistorted A.C., the output is sufficient for 75 couples to dance.

CAPACITY — The type "66" will handle the output of two PP5-400 or two D.O 26 valves in push - pull, with an adequate margin of safety.

PRICE :—

D.C. Model (700 or 2,000 ohms) **£5-17-6**

A.C. Model (any frequency) - **£7-17-6**

For complete data, send 3d. in stamps for booklet entitled "Some Technical Details of the Magnavox Model 66."

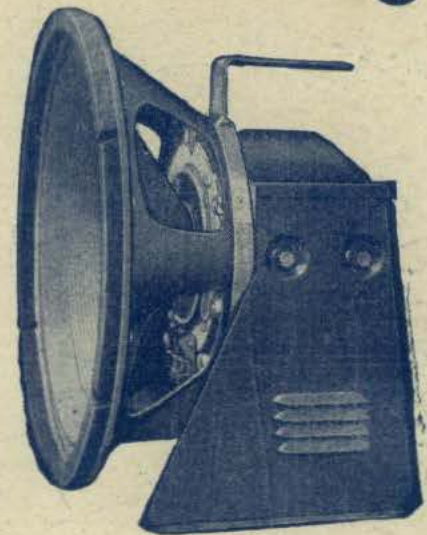

MAGNAVOX

THE BENJAMIN ELECTRIC LTD., BRANTWOOD WORKS, TOTTENHAM, N. 17.

The Wireless World

4^D

THE
PRACTICAL RADIO
JOURNAL

with

Complete Foreign Programmes

Friday, July 27th, 1934.

RADIOPHONE for RELIABILITY - a Component for Every Need

Complete Range of
VOLUME CONTROLS

from 4/-

and

Q.M.B. SWITCHES

from 1/3

*There is nothing to equal Radiophone
for Quality and Lasting Efficiency.*

BRITISH RADIOPHONE LTD.,
ALDWYCH HOUSE, LONDON, W.C.2.



NOW
4 NEW "Q.M.B."

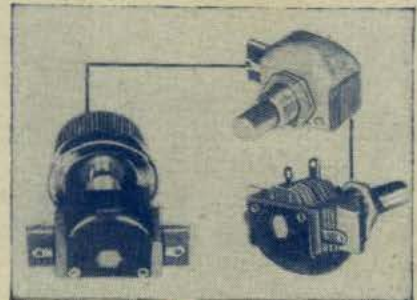

SEMI-ROTARY SWITCHES

No. 161	...	S.P.S.T.	1/9
No. 163	...	S.P.D.T.	2/6
*No. 2161	...	D.P.S.T.	3/6
*No. 2163	...	D.P.D.T.	4/-

*Specified in the "BATTERY SINGLE-SPAN" SET,
described in this issue.

CLAUDE LYONS LTD.,
Head Office: 76, OLDHALL STREET, LIVERPOOL, 3.
LONDON: 40, BUCKINGHAM GATE, S.W.1.

The variable colverstat



★ The Supreme variable resistance, with unique smoothness of control and complete freedom from noise. Can be supplied in standard values up to 50,000 Ohms. Fit Colvern products in your set, and be certain of the best results.

TYPE ST5CS

Potentiometer complete with on and off switch, 5/- each
Battery or Mains at

Another famous

COLVERN

Product

COLVERN LTD., ROMFORD, ESSEX.
London Depot: 150, King's Cross Road, W.C.1

TELSEN D.R. TRANSFORMER

-the L.F. Transformer with a STRAIGHT LINE

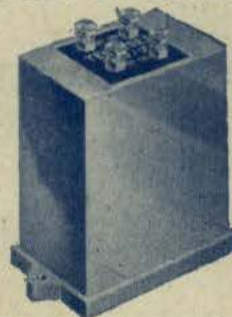

CHARACTERISTIC

which gives UNIFORM AMPLIFICATION over the entire range of audio-frequencies. The spaced layer windings are impregnated with a non-hygroscopic material of very low specific inductive capacity which absolutely eliminates all possibility of shorted turns or breakdowns due to large magnetic surges

D.R.3
(ratio 3-1)
D.R.5
(ratio 5-1)

8'6

Announcement of the Telsen Electric Co., Ltd., Aston, Birmingham.

TELSEN FOR EVERYTHING IN RADIO



KINGS OF THE AIR

WIDEN YOUR CHOICE OF PROGRAMMES

No matter what type of Receiver you use—Battery or All-Electric (A.C. or D.C.)—there is a Cossor Screened Grid Valve to suit it. By fitting one of these highly efficient valves you can considerably widen your choice of programmes.

Because Cossor S.G. Valves have negligible inter-electrode capacity they permit exceptionally high effective amplification, and this means increased range. To fit a Cossor Screened Grid Valve, therefore, is a simple way of improving performance.

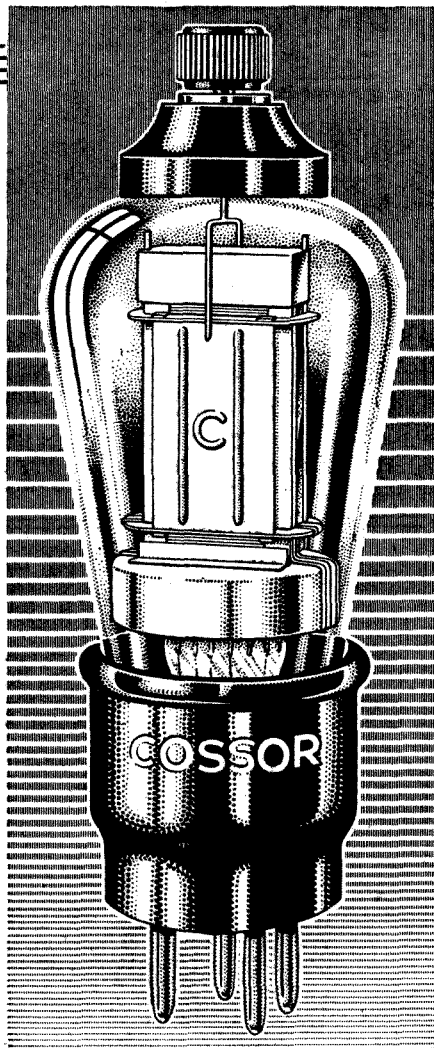

COSSOR

SCREENED GRID VALVES

FREE!
72-page
WIRELESS
BOOK

From cover to cover this Cossor 72-page Wireless Book is packed full of useful and interesting information—latest circuits—explanations of technical terms—how a superhet works, etc. Send at once for free copy. Please use the coupon.

Cossor 2-volt Screened Grid Valves

Type	Fila-ment Amps.	Anode Volts	Imped.	Amp. Factor	Mutual Conduc-tance m.a./v.	Price
*215 S.G.	.15	120-150	300,000	330	1.10	15/6
*220 S.G.	.2	120-150	200,000	320	1.60	15/6
*220 V.S.G.	.2	120-150	110,000	—	1.60	15/6
*220 V.S.	.2	120-150	400,000	—	1.60	15/6

Cossor A.C. Mains Screened Grid Valves

Type	Purpose	Imped.	Amp. Factor	Mutual Conduc-tance m.a./v.	Price
*†MSG-HA	Super H.F. Amp'n.	500,000	1,000	2.0	17/6
*41 MSG	Super H.F. Amp'n.	400,000	1,000	2.5	17/6
*†MSG-LA	Super H.F. Amp'n.	200,000	750	3.75	17/6
*†MVSG	Variable-Mu S.G.	200,000	—	2.5	17/6

The above Valves have Indirectly Heated Cathode, 4 Volts, 1 Amp.

Cossor D.C. Mains Screened Grid Valve

*†DVSG	Variable-Mu S.G.	—	—	2.5	17/6
--------	------------------	---	---	-----	------

The above Valves have Indirectly Heated Cathode, 16 Volts, 0.25 Amp.

* These Valves available with or without Metallised Bulbs

† Characteristics measured at -1.5 grid volts.

** Stocked with Metallised Bulb only.

USE THE COUPON

To A. C. COSSOR LTD.,
Melody Dept., Highbury
Grove, London, N.5.

Name

Please send me free of charge,
a copy of the Cossor 72-page
Wireless Book.

Address.....

B.V.33

W.W. 27/7/34.....



Mention of "The Wireless World," when writing to advertisers, will ensure prompt attention.

The Wireless World

THE
PRACTICAL RADIO
JOURNAL
24th Year of Publication

No. 778.

FRIDAY, JULY 27TH, 1934.

VOL. XXXV. No 4.

Proprietors: ILIFFE & SONS LTD.

Editor:
HUGH S. POCOCK.

Editorial,
Advertising and Publishing Offices:
DORSET HOUSE, STAMFORD STREET,
LONDON, S.E.1.

Telephone: Hop 3333 (50 lines).
Telegrams: "Ethaworld, Watloo, London."

COVENTRY: Hertford Street.
Telegrams: "Cyclist, Coventry." Telephone: 5210 Coventry.

BIRMINGHAM:
Guildhall Buildings, Navigation Street, 2.
Telegrams: "Autopress, Birmingham." Telephone: 2970 Midland (3 lines).

MANCHESTER: 260, Deansgate, 3.
Telegrams: "Iliffe, Manchester." Telephone: Blackfriars 4412 (4 lines).

GLASGOW: 26B, Renfield Street, C.2.
Telegrams: "Iliffe, Glasgow." Telephone: Central 4857.

PUBLISHED WEEKLY. ENTERED AS SECOND
CLASS MATTER AT NEW YORK, N.Y.

Subscription Rates:
Home, £1 1s. 8d.; Canada, £1 1s. 8d.; other
countries, £1 3s. 10d. per annum.

*As many of the circuits and apparatus described in these
pages are covered by patents, readers are advised, before
making use of them, to satisfy themselves that they would
not be infringing patents.*

CONTENTS

	Page
Editorial Comment	51
American Sets and Valves	52
Unbiased	54
Single-span Developments (con- cluded)	55
Resistance Tuning	58
Electrical Interference	59
The Art of Ganging—VIII	61
News of the Week	62
FOREIGN PROGRAMME SUPPLEMENT, pp. I—XIV	
Broadcast Brevities	63
Audio-Frequency Test Oscillator (concluded)	64
Letters to the Editor	67
New Apparatus Reviewed	68

EDITORIAL COMMENT

Electrical Interference

The Problem of a Definition

IN this issue we publish an important contribution on the subject of electrical interference, with particular reference to the problem of a definition.

We had hoped that long ere this some steps would have been taken to begin the suppression of interference by applying known and inexpensive methods to new electrical equipment which is constantly being distributed. Perhaps we have been over optimistic, but be that as it may, those whose business it is to see the matter through have evidently come to the conclusion, after careful deliberation, that agreement on the subject is not possible, nor can legislation be introduced until a definition of interference be arrived at and accepted, not only in this country but internationally. For this reason the various methods for measurement of interference which have been adopted in different countries are all being examined, with the object of trying to bring them to a common basis, so that electrical apparatus manufactured in any country will conform to the regulations of any other country to which such equipment may be exported.

Disappointing Delay

We recognise that such a solution would be ideal, although we cannot refrain from expressing regret that it should be considered impracticable to introduce some form of interim regulation in this country which would prevent the distribution of an enormous amount of interfering apparatus throughout the land at a time when the public is adopting electrical appliances at a very rapid rate.

To arrive at international agreement must inevitably mean a considerable delay.

It is gratifying to learn that an integral part of the British method of dealing with the problem is to draw up a specification for the performance of "radio-interference-free" electrical appliances, and that the framework of such a specification has been prepared.

We wish all success to these endeavours, which we hope will achieve their object with the least possible delay. The problem daily grows more urgent.

Set Identification

But the Name Need Not Intrude

IN a letter published in the Correspondence columns of this issue Mr. Frank Murphy endorses the view expressed in a leader in our issue of July 13th, that every set should carry the name of the maker and provide a permanent advertisement so benefiting the manufacturer (if it is a good set) whilst at the same time assisting the user who may from time to time have need to know what set he owns.

Mr. Murphy suggests that our leader might convey the idea that it was our intention to recommend that the maker's name should be prominently displayed on the front of the cabinet. Murphy sets are all prominently labelled, but on the back of the cabinet. This is certainly all that is necessary. We would ourselves discourage manufacturers from putting the name on the front and have often wondered how piano manufacturers seem to have got away with the idea of every owner carrying an advertisement in his drawing room.

American Sets and Valves

Receivers for Motorists and Battery Users

IN "The Wireless World" of May 25th the popular American Midget Superheterodyne was critically described. The author of that article now discusses two other specialised types of receiver, both of which have been highly developed in the U.S.A.

THE typical American motor car set is really a special kind of "midget," with rather higher sensitivity (to compensate for a necessarily poor aerial) and capable of giving rather greater volume. An output of at least 2 or 3 watts is considered necessary, as it is astonishing how weak the signals appear against the background of noise in a motor car. Since the receiver is often employed when the car is travelling amid obstructions that introduce a constantly varying amount of screening, a highly efficient automatic volume control system is essential.

Five valves are employed in the typical car set, which, as shown in Fig. 1, is very similar to a midget set, with the addition of a signal-frequency H.F. stage to supply the needed extra sensitivity.

To avoid duplication of types the same valves as in the midgets are used where possible in the car sets. However, as the valves of the latter are connected in parallel across the 6-volt car battery, the 25-volt Type 43 output pentode would be unsuitable; instead, the Type 41 valve, of which the dynamic characteristics are shown in Fig. 2, is substituted. The heating element of this valve takes 0.7 amp. at about 6.3 volts. The principal characteristics of the other valves are shown in the table.

Robust Valve Heaters

The American motorist expects his valves to operate well, whether the car battery be giving 4 volts or 8 volts. That he is not disappointed is a notable testi-

By J. H. OWEN HARRIES

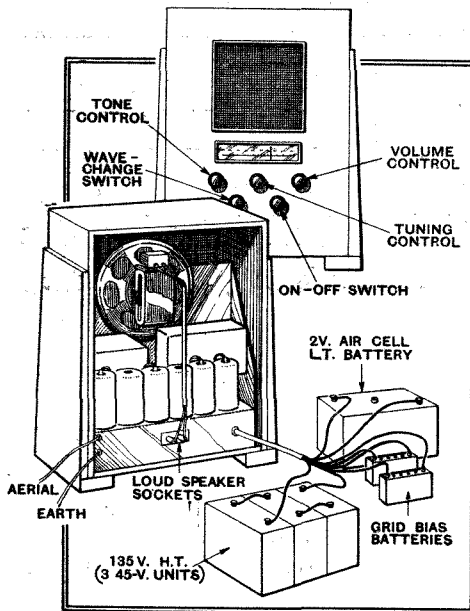

Layout of an American battery superhet.

mony to the remarkable factor of safety of the heating elements of American valves. However, this robustness is only attained at the expense of a higher filament wattage per milliwatt emission as compared with British valves.

The H.T. supply problem has now been solved in a remarkable way by a vibrating make-and-break, operating in conjunction with an induction coil from the car accumulator. Like the earlier form of vibratory H.T. generator the contacts

interrupt the primary circuit, and in addition they now rectify the high-tension output. A separate rectifying valve is therefore no longer required. An ample output of current at a voltage of about 250 is produced.

The vibrator and rectifier unit, which is about the size of a valve, produces no noise in the receiver, and has proved entirely reliable; it is manufactured for about four shillings. Those of us who have struggled with buzzers in the days when they were used in conjunction with wireless sets can have nothing but admiration for the achievement of American engineers in producing these remarkable little H.T. units.

Car Radio Circuits

Referring again to Fig. 1, it will be observed that the radio-frequency valve V1 is coupled by a tuned transformer to a pentagrid frequency changer, V2, of which the circuits are conventional. Intermediate frequency amplification is carried out by V3, and detection and L.F. amplification by a double-diode-triode, V4. Voltages for volume-control purposes are obtained from a tapping on the diode load resistance.

The H.T. and L.T. supply circuits are clearly shown in the diagram. The car battery supplies current to the primary of the transformer when one or other of the two make-and-break contacts of the vibrating reed are closed. The resulting pulses of current in the primary produce corresponding high-tension pulses across the secondary. These are rectified by the

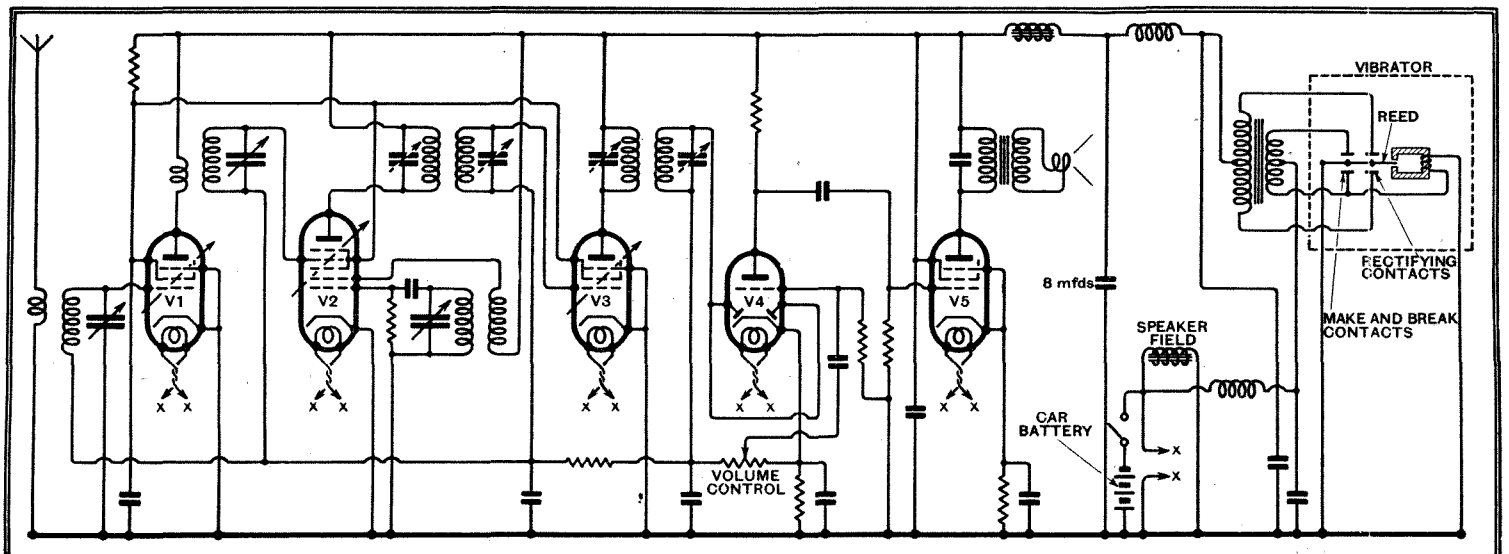

Fig. 1.—Circuit diagram of a typical modern American car set.

American Sets and Valves—

other pair of contacts on the reed. The resulting pulses of rectified H.T. current are smoothed in the usual way, though it will be noted that H.F. chokes are inserted in the output leads to prevent the transmission of interference to the receiver circuits. Both filaments and loud-speaker field are connected directly across the car battery. Delayed A.V.C. is a refinement to be found in the more ambitious car receivers.

For Country Districts

It has been estimated that the American market for battery receivers amounts to about one-third of the total, but it has hardly been exploited. For instance, the high output offered by British receivers which consume only 8 or 10 milliamps is entirely unknown. The average American battery set takes about 20 milliamps at 135 volts, and gives only some 700 milli-watts output.

At last, however, there are signs that the American manufacturer is turning his attention to the battery set market and

ments of valves at a constant voltage from dry batteries has not been entirely solved. There is, of course, the baretter, a special form of resistance which has the property of raising its value as the current through it tends to increase. Thus, the filaments of 2-volt valves connected to a 3-volt dry battery through a baretter might be made to work at their rated voltage until the

valves as defective. And in America "the customer is always right"!

The Patent Office at Washington is piled high with specifications for automatic voltage-regulating devices, but none of them seems to have reached the stage of standard commercial use.

The best solution of the battery problem so far is the two-valve "air-cell," which is a primary battery, and an expensive one at that, but which is capable of giving half an ampere for the better part of a year. Depolarisation is performed by the oxygen of the atmosphere, and the voltage amounts to about 2.4 volts throughout its long life. It is filled up with water by the user, and requires little more than common-sense attention such as topping-up with water to make good evaporation. Even that small amount of attention is not always forthcoming, and the battery is returned as defective. Again, "the customer is always right."

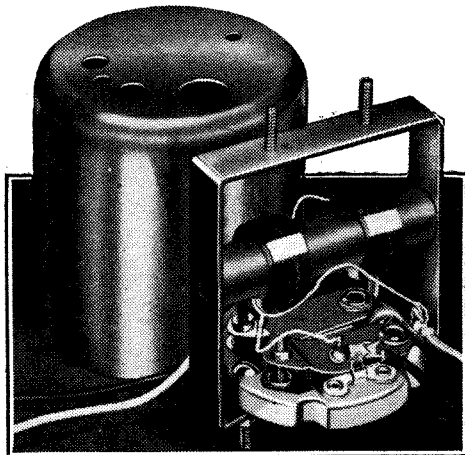

Band-pass I.F. transformer, as used in American sets.

American Superhet. Practice

The more ambitious type of battery-fed receiver is nowadays a seven-valve superheterodyne with several interesting features. One of the most unusual is the method of manual volume control, which is carried out by varying the coupling of one of the I.F. transformers. A separate

battery voltage dropped to nearly 2 volts.

Unfortunately baretters are unreliable and have an unpleasant habit of ceasing to operate without warning. For instance, when a new battery is connected to replace an exhausted one, the valves are liable to receive an excessively high filament voltage. Result: recriminations all round, between customer, supplier, and valve manufacturer.

Battery Users' Tribulations

Manually adjusted rheostats are equally unpractical. The set-user always turns them on too far and then returns the

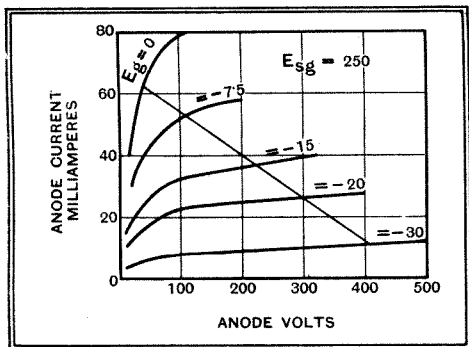

Fig. 2.—Dynamic characteristics of output pentode No. 41, as used in American car sets. Output at 10% harmonic distortion is 3 watts.

its special technical problems. He has found, as we have found in England, that an output of 2 watts is obtainable from a battery set by making use of quiescent amplifying systems.

In England, where distances are short, we have accepted the accumulator, which maintains a steady voltage, as a practical source of L.T. supply. In the U.S.A., where immense tracts of farming country are without mains or accumulator-charging facilities, it is far less satisfactory.

So far, the problem of supplying fila-

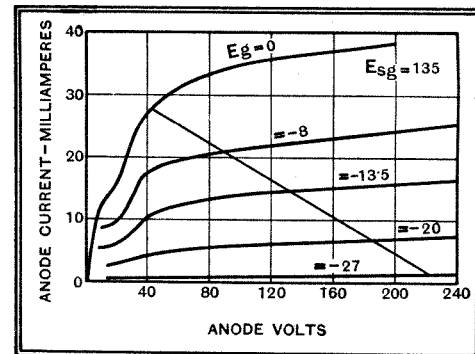

Fig. 4.—Two-volt output pentode, giving 700 milliwatts with 7½% harmonic distortion.

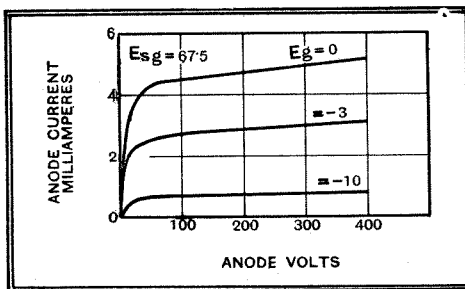

Fig. 3.—Characteristics of the battery-fed variable-mu screened pentode, type 234.

triode valve, with anode and grid strapped together, acts as a diode for A.V.C. purposes only, while the second detector operates on the anode bend principle. All filaments except the output valve, of which the characteristics are shown in Fig. 4, consumes 0.26 amp.

The most noticeable differences between British and American valve technique may be summarised quite briefly. The American screened valves have the control-grid connection led out through the top of the bulb, the advantage of this plan being a reduced capacity between this electrode and the other grids. In the British valves, where the control grid is connected to its pin through the pinch at the base of the valve, this electrode is not shielded from the other grids. An additional advantage of leading the connection out through the top of the valve is that the exposed metal is not at H.T. potential, and thus one of the requirements of the underwriters is satisfied.

The mutual conductance of American

TABLE.

Valve Type.	Heater Volts.	Heater Amps.	Mut. Conductance (mA/v)	Impedance (ohms.)	Working Anode volts.	Working Screen volts.	Grid bias.
6A7 Pentagrid ..	6.3	0.3	0.475	300,000	140	100	A.V.C.
78 Screened pentode..	6.3	0.3	1.45	600,000	140	100	A.V.C.
75 Double-diode-triode	6.3	0.3	1.1	91,000	140 through resis.	—	+2
43 Pentode ..	25	0.3	2.3	—	140	140	-20
25Z5 Rectifier ..	25	0.3	—	—	—	—	—

American Sets and Valves—

valves is distinctly lower than that of their British counterparts. This is largely a matter of cost; the insolvent state of the American valve industry precludes the spending of money on obtaining the closer clearances and finer workmanship of the British product.

A standard American A.C. pentode (the 43) has a mutual conductance of about 2 mA/volt, while the figure for the corresponding British valve is about 4 mA. per volt. Both valves have about the same cathode wattage.

As a result of the craze for midget receivers, American valves are generally much smaller than their British equivalents, and in some cases efficiency was sacrificed in order to please the set manufacturers. The bulb area is too small for

adequate dissipation of heat, and often output pentodes and mains rectifiers are run too hot to be handled. In spite of

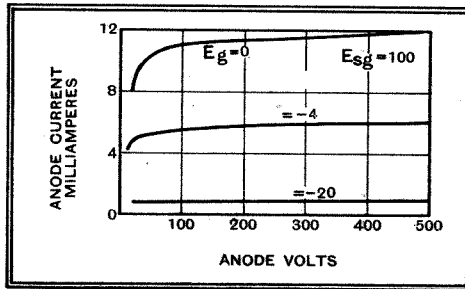

Fig. 5.—Variable-mu screened pentode, type 78.

these shortcomings the American valve in general is a robust mechanical job, and is non-microphonic.

UNBIASED

By FREE GRID

The High Jump

THE interest taken in my few notes concerning photo-electric cells has been quite considerable, several readers writing to tell me of remarkable instances of the application of these devices to everyday life. Probably the most interesting, however, is one which was actually demonstrated to me the day after my words appeared in print.

As a result of my paragraph a friend telephoned to say that if I cared to accompany him on the following day to his daughter's school sports he would give me an "eye-opener."

It was with some diffidence that I approached the subject of putting in an appearance at a girls' school, but in the end my curiosity got the better of my blushes, and the following day saw me in a train with my friend, bound for the fee-snatching establishment to which he had consigned his female offspring.

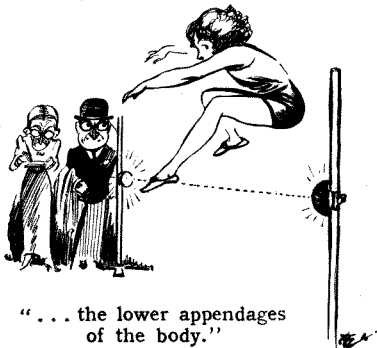

In spite of my friend's promises I scarcely expected to find such a remarkable instance of modernity in the hoary old establishment in which we eventually found ourselves. The instance in question was what I can only describe as a photo-electric high-jump indicator.

In place of the customary horizontal chunk of wood there was a narrow but

powerful pencil of light linking the two vertical posts. This emanated from a focused electric lamp on one post and shone across into the "eye" of a deeply hooded photocell on the other. The deep hood in which the cell was sunk, coupled with the strength of the focused pencil of light, ensured that only the lamp and not the daylight, even on the sunniest day, should have any controlling influence on the cell.

Naturally the effect of any girl's missing the jump was to cut the ray, and this sounded an electric fog-horn.

Although admiring the ingenuity of the whole thing, I failed to see that it was in any way an improvement over the more homely chunk of wood to which I had been accustomed in my schooldays, so I sought enlightenment on the matter from the headmistress, a woman of the usual thoroughbred misandristic type which an ever-thoughtful Nature seems to produce specially for pedagogic purposes.

"It is evident," she explained coldly, choosing her words with academic exactitude, "that you are unacquainted with the intricate psychological reactions of the female. Whereas a male, owing to the relative coarseness of his nature, will readily jump at a crude bar of wood without what is vulgarly known as 'baulking,' the female, with her delicately balanced psychological constitution, is unable to do so. This application of science," she continued, "definitely solves the problem, as in the event of failure to clear the height there is nothing to get entangled with the lower appendages of the body."

Personally speaking, I should have thought that the use of an *invisible* ray would have been better still, as it would have stirred the girls to maximum effort all the time, as they would never know at what height the wretched thing was.

At any rate, I spent a very pleasant afternoon, and came away with the definite impression that the modern schoolgirl has what those set in authority over her would describe as remarkably fine corporeal appendages.

Good News

IT is astonishing, but nevertheless gratifying, to learn what avid readers of this journal are the various dog fanciers who clutter up the stands at Olympia during August. It will be remembered that quite recently I expressed fears that there was likely to be a great dearth of exhibitors this year due to the fact that, according to their own statements to the Press, many of the manufacturers had sold the whole of their factory output for several years ahead within a few hours of the opening of last year's show.

I have now been inundated with correspondence which leaves me in no doubt concerning the success of this year's show, nor indeed of the ingenuity of our manufacturers. "It says little for your intelligence," writes the big noise of one well-known firm, "that you should seek to cast doubt upon the statements made to the Press by this and other firms of re-



"... inundated with correspondence."

pute. Naturally enough, we immediately acquired extra land and put in hand the building of bigger and bigger factories, with the result that we were able to give delivery of all the goods ordered in record time, long before Christmas, in fact. Furthermore, we would have you know that we anticipate such an increase of business at this year's show that extensions of similar magnitude to our premises and personnel will be necessary."

My readers will, I am sure, acquit me of any intention to cast aspersions on the veracity of our great business houses. I am only too pleased to publish these few facts, if only to show how resolutely the unemployment problem is being tackled.

The state of affairs which my innocent remarks has brought to light is still rather alarming, however, for at the present rate of increase not only will all our treasured beauty spots have been swept away before the ruthless hand of the factory builder long before 1940, but the time will come when so many people will be employed in making sets that nobody will be left to use them.

Single-Span Developments

Concluded
from page 40
of last week's
issue.

By W. T. COCKING

Methods of Increasing Selectivity

IT has often been suggested that double-frequency-changing be employed in order to obtain single-span tuning with normal superheterodyne characteristics as regards selectivity. The problems involved in such a scheme are discussed in this article, and it is shown that although it is possible to obtain good results the arrangement is unsuitable for many purposes.

IT was shown in last week's issue of *The Wireless World* that the only point in which single-span receivers might be said to suffer in a comparison with the usual type of superheterodyne is in regard to adjacent channel selectivity. It has been suggested that this could be got over by using double-frequency-changing—the proposed scheme being to use a high first intermediate frequency to secure single-span tuning, and then a second fixed frequency-changer to feed a second intermediate frequency amplifier operating at a low frequency to obtain high selectivity.

An arrangement of this nature was actually employed by the writer over a year ago, and it can be made to operate very satisfactorily indeed. There are, however, certain difficulties which are not apparent at first sight, so that the method may be worth discussing in some detail. Double-frequency-changing offers many fresh problems to the designer; there are the interference problems peculiar to single-span tuning for which no new treatment is needed, there are the normal superheterodyne problems to which the solution is somewhat easier, and there is a number of fresh problems entirely consequent upon double-frequency-changing.

Let us first consider what double-frequency-changing with single-span tuning involves. The various stages are shown diagrammatically in Fig. 1, and the first two are in no way different from other single-span receivers. There is the special aerial coupling system passing frequencies between 150 kc/s and 1,500 kc/s to the first frequency-changer, but attenuating frequencies outside this range. The first frequency-changer con-

tains an oscillator tunable over the range of 1,750 kc/s to 3,100 kc/s for a first intermediate frequency of 1,600 kc/s. All tuning is carried out by means of the variable condenser controlling this oscillator, just as in an ordinary single-span receiver.

The first I.F. amplifier comes next, but this may be only a courtesy title, for amplification at this stage is not essential, and a simple chain of resonant circuits tuned to 1,600 kc/s may suffice. In most cases, however, it will be convenient to obtain a degree of amplification at this point.

Now we must remember that all frequencies between 150 kc/s and 1,500 kc/s are applied to the first frequency-changer. Suppose that the first oscillator is set to work at 2,600 kc/s so that a 1,600 kc/s beat is formed with a station on 1,000 kc/s. The oscillator will beat with all other stations and convert the 150-1,500 kc/s band to one of 2,450-1,100 kc/s. If the oscillator be set at 3,000 kc/s to receive a station on 1,400 kc/s, the band shifts to 2,850-1,500 kc/s. We

sponding to all broadcasting stations, and it is the duty of this amplifier to select the frequency corresponding to the station it is wished to receive. So far this is no different from the usual single-span arrangement, but the output of the amplifier in which the 1,600 kc/s frequency is, or should be, predominant, is applied to the second frequency-changer which contains an oscillator working at either 1,710 kc/s or 1,490 kc/s. Whichever frequency be used, it beats with the 1,600 kc/s input to give an output of 110 kc/s which is applied to the second I.F. amplifier, in which final amplification and a high degree of adjacent channel selectivity are obtained.

Interference Possibilities

Apart from the frequency-changers, the apparatus can be divided into three main sections, each of which must fulfil a single definite function as regards selectivity. The function of the second I.F. amplifier is to provide adjacent channel selectivity, and no unusual problems enter here, for it is only the usual question of selectivity *v.* quality. The first I.F. amplifier must be selective enough to prevent second channel interference at the second F.C. from occurring, and also to prevent the other forms of whistle production peculiar to the ordinary superheterodyne. The aerial coupling must pass the desired receiving band, but attenuate other frequencies sufficiently to prevent second channel interference at the first F.C.

Assuming inadequate selectivity, there are thus three frequencies instead of one from which

second channel interference may occur. With a first I.F. of 1,600 kc/s, a second I.F. of 110 kc/s, a second oscillator frequency of 1,490 kc/s, and a first oscillator frequency of 2,600 kc/s for the reception of a station on 1,000 kc/s, let us see how

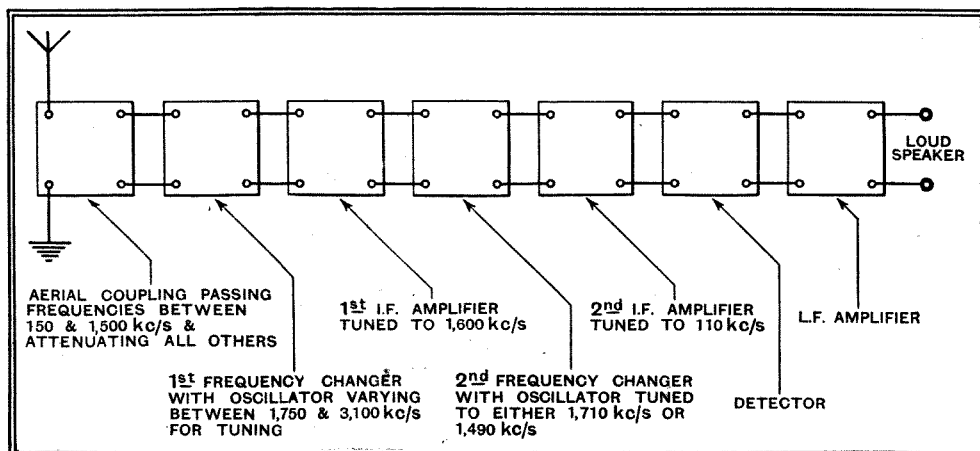

Fig. 1.—The general scheme of a single-span receiver embodying double-frequency-changing is illustrated here.

can, therefore, regard the first frequency-changer as moving the whole band of frequencies to be received, as we rotate the tuning condenser.

The input to the first I.F. amplifier, therefore, contains frequencies corre-

Single-Span Developments—

this interference may occur. We have 1,000 kc/s beating with 2,600 kc/s to produce 1,600 kc/s, which beats with 1,490 kc/s to produce 110 kc/s. Now it is obvious that if the 1st I.F. amplifier contains a frequency of 1,380 kc/s, this will beat with 1,490 kc/s also to give a 110 kc/s output. A frequency of 1,380 kc/s will be produced by the first oscillator on 2,600 kc/s from a signal on either 1,220 kc/s or 3,980 kc/s. The true 1st I.F. of 1,600 kc/s is produced by beating with 2,600 kc/s either 1,000 kc/s or 4,200 kc/s. Thus for any setting of the controls there are four signal frequencies which may be passed to the 2nd I.F. amplifier, and in this case they are 1,000 kc/s, 1,220 kc/s, 3,980 kc/s, and 4,200 kc/s.

The last two are eliminated by providing a sufficiently high degree of attenuation in the aerial filter, for they are outside the desired tuning range. We need only concern ourselves with the first pair, therefore. Both are within the receiving range, so that the aerial filter cannot help us here. The second I.F. amplifier can give no aid, and it is upon the 1st I.F. amplifier that the burden must fall.

The 2nd I.F. amplifier is exactly analogous to the I.F. amplifier of an ordinary superheterodyne, and the 1st I.F. amplifier replaces the signal-frequency tuning circuits, the only difference being that its tuning need not be varied in any way. Just as in the ordinary superheterodyne it is the signal-frequency circuits which must prevent second channel interference and other forms of whistle production, so in a double-frequency-changing single-span receiver the onus falls upon the first intermediate frequency amplifier. There is, however, one alleviating circumstance—the tuning is fixed. Ganging errors, therefore, which reduce the selectivity of the ordinary pre-selector are absent, and it is possible to use specially selective devices which would be inapplicable to circuits with variable tuning.

Oscillator Interaction

It will be seen, therefore, that the use of double-frequency-changing brings to single-span all the possibilities of whistle production present in an ordinary superheterodyne, but that these are more easily reduced to negligible proportions by the absence of variable tuning.

The next point to be considered arises neither with single-span tuning nor the ordinary superheterodyne, but it may be important in any set embodying double-frequency-changing. Unless great care be taken in design, interaction will occur between the two oscillators and give rise to many undesirable effects. Each oscil-

lator inevitably generates harmonics, and it is these harmonics which can cause trouble in several different ways.

Let us assume, for the moment, that all the possibilities of harmonic trouble can occur, and see what the effects are likely to be. If the second intermediate frequency is 110 kc/s and the first 1,600 kc/s, the second oscillator must be either 1,710 kc/s or 1,490 kc/s. The latter frequency is obviously undesirable, for it is within the required receiving range. It has already been shown, however, that a slightly higher frequency may prove desirable on other grounds, so let us choose a first intermediate frequency of 1,680 kc/s. The second oscillator must then be either 1,790 kc/s or 1,570 kc/s, and the first oscillator must be variable over

fundamental frequencies of the oscillators which are much stronger than the harmonics. Now it will be seen that if we choose the higher frequency of 1,790 kc/s for the second oscillator, the first oscillator must not be tunable to a frequency lower than 1,900 kc/s, otherwise trouble will occur. In order to cover the required receiving range, however, the oscillator must be variable to as low a frequency as 1,830 kc/s. If we choose this oscillator frequency, therefore, we must expect trouble when receiving a station on 220 kc/s.

Oscillator Harmonics

By using the lower frequency for the second oscillator, however, this effect is completely avoided, and no whistles involving the fundamental frequencies of both oscillators can be produced. In spite of the fact that the harmonics are likely to prove more troublesome, we must definitely decide to use the lower frequency of 1,570 kc/s for the second oscillator.

It will be obvious that complete freedom from whistles produced by oscillator harmonics would be obtained if either oscillator could be prevented from generating them. This is not completely possible, but steps can be taken to keep them at a minimum. Something more is needed, however. Good screening of each oscillator is necessary in order to prevent the stray fields from interacting.

An arrangement which might be used for the second frequency-changer is shown in Fig. 2. The 1,680 kc/s input is applied to the detector grid, and the 1,570 kc/s oscillator potential is injected into the cathode lead together with any oscillator harmonics. Now although the 1,680 kc/s circuits which are connected between the two frequency-changers exercise a selective action upon any frequencies produced by the first oscillator, it must be remembered that these oscillator potentials are likely to be, and in fact should be, much stronger than any signal so that the input to the second frequency-changer may be appreciable.

It will be seen, therefore, that every effort should be made to prevent harmonics of the second oscillator from reaching the detector, and one way of doing this is shown in Fig. 3. The coupling between the oscillator and detector is arranged by means of a tuned circuit L1, L2, C tuned to the oscillator frequency of 1,570 kc/s. This circuit exercises a selective action on the oscillator output and effectively reduces the harmonic content to an exceedingly low figure.

With an arrangement of this nature double-frequency-changing can function in a satisfactory manner, and it is possible to obtain freedom from the various

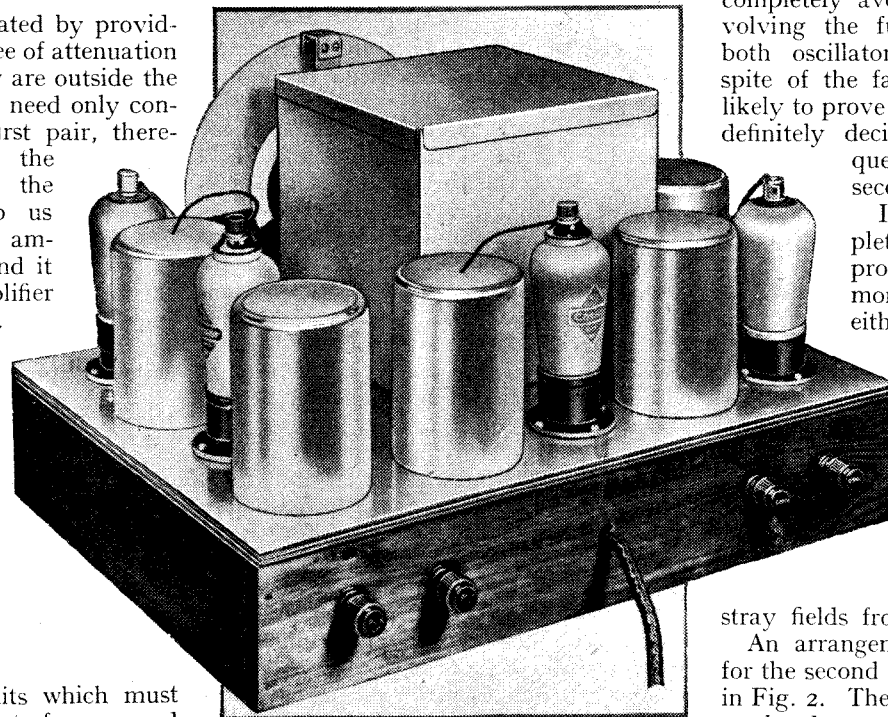

A rear view of a single-span receiver of high selectivity.

the range of 1,830 kc/s to 3,180 kc/s.

Whichever oscillator frequency we choose, the fundamental does not fall within the 1st harmonic range of the first oscillator, so that we shall have no difficulty on this score. The second harmonic of 1,790 kc/s, however, is 3,580 kc/s, and of 1,570 kc/s is 3,140 kc/s. The former comes within the fundamental range of the first oscillator, but the latter does not, so that it would seem wise to choose the higher of the two possible frequencies for the second oscillator. Higher harmonics may be important, and the 3rd harmonics of the two possible oscillator frequencies are 5,370 kc/s and 4,710 kc/s, while the second harmonic range of the first oscillator is 3,660-6,360 kc/s. Whichever oscillator frequency we choose, therefore, its third harmonic will fall within the second harmonic range of the first oscillator.

Another point must now be considered. If the first oscillator can be adjusted to a frequency 110 kc/s different from that of the second oscillator serious interference may occur, for we are concerned with the

Single-Span Developments—

forms of whistle production. The particular arrangement of Fig. 3, however, is not without its disadvantages, the chief of which is the difficulty of adjusting the condenser C. It will be found that a

the second harmonic input to the detector by 75 per cent. The reactance of the usual inductance coupling increases with frequency so that it is twice as great at the second harmonic frequency as at the fundamental. The reactance of a capacity

coupling, however, falls with frequency, and at the second harmonic is only one-half of that at the fundamental.

The second factor tending to reduce the efficiency of the coupling at the harmonic frequencies is the coupling into the tuned circuit instead of into the cathode lead of the valve, for the 1,600 kc/s circuit LC then exercises some selective influence on the oscillator output and reduces harmonics.

mean that it is a desirable one. The great difficulty about double-frequency-changing is the initial adjustments. Not only are there two sets of I.F. circuits to be adjusted to two different frequencies but the second oscillator must be set precisely at a third frequency. This can only be done easily and accurately with the aid of a calibrated oscillator, and this is a piece of apparatus which few constructors have available. If the adjustments are not accurately performed, the performance of the set is likely to be very poor, and as the symptoms of the various faults are so similar it is difficult to diagnose the exact cause.

In spite of the system being capable of a good performance, therefore, we must conclude that it is unsatisfactory for a constructional receiver owing to the difficulties of adjustment. In a commercially produced set where suitable apparatus can be used for the adjustments, it may prove entirely satisfactory.

If double-frequency-changing cannot be called in to help in obtaining increased selectivity, the logical course is to attain this desirable end by an increase in the number of tuned circuits at the high inter-

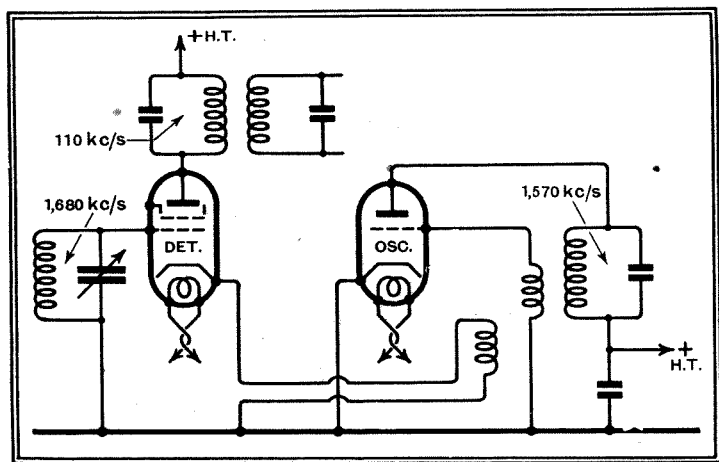

Fig. 2.—One method of coupling the oscillator and detector in the second frequency-changer.

variation of this capacity makes little difference to signal strength, but a big difference to the heterodyne voltage impressed upon the detector and to the filtration of harmonics. The only accurate method of adjusting this condenser is with the aid of a valve voltmeter to measure the detector input, and this is obviously very inconvenient.

Now a little thought will show that there is little use in going to extremes in order to obtain a pure input to the detector, for it is extremely probable that the detector will itself generate harmonics of the oscillator potentials. These harmonics will not be so serious as those generated in the oscillator itself, for they will not be as strong, but there is little point in providing a very high degree of filtering to the oscillator output.

The connections shown in Fig. 4, therefore, have been found quite as satisfactory as the tuned coupling of Fig. 3, and the provision and adjustment of a tuned circuit is saved. In the first place a capacitive, instead of the usual inductive, coupling is used, and this alone reduces

A single-span receiver embodying double-frequency-changing can be made to operate in an entirely satisfactory manner by adopting the principles which have been discussed in this article. By using a sufficiently large number of tuned circuits in the second I.F. circuits the adjacent channel selectivity can be made as high as desired, and the normal superheterodyne type of whistle production can be avoided by the inclusion of four or more tuned circuits in the first I.F. amplifier. Interaction difficulties can be overcome by proper design.

The fact that a receiving system can be made to function well, however, does not

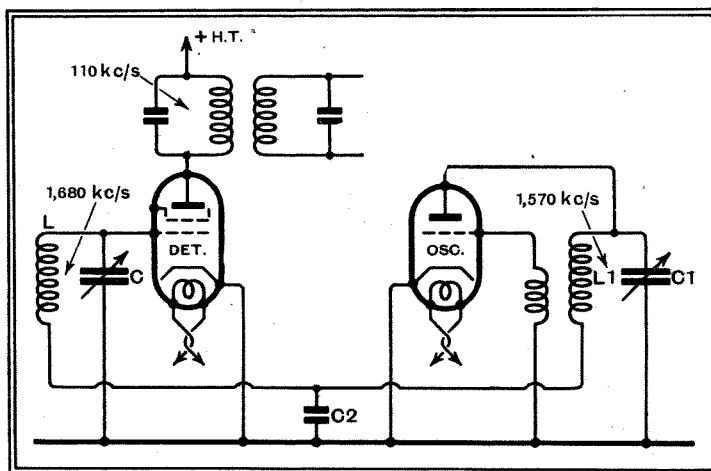

Fig. 4.—An extremely simple method of oscillator coupling which leads to a low harmonic output.

mediate frequency of the straightforward single-span system. This does not increase the difficulties of adjustment to any appreciable degree, for all circuits are lined up to the same frequency, and the exact frequency is not critical. The selectivity obtainable with the existing single-span receivers is greater than that of the majority of straight sets, and although it is lower than that of ordinary superheterodynes, it has been found adequate for the reception of most worthwhile transmissions. This may seem surprising in view of the fact that the number of circuits used is less than in most superheterodynes, but it is to be attributed to the highly efficient circuits obtained.

It will thus be obvious that taking all points into consideration a higher degree of selectivity is best obtained by an increase in the number of tuned circuits, and the benefits accruing from this are to be found not only in increased adjacent channel selectivity but also in the reduced spread of local transmissions.

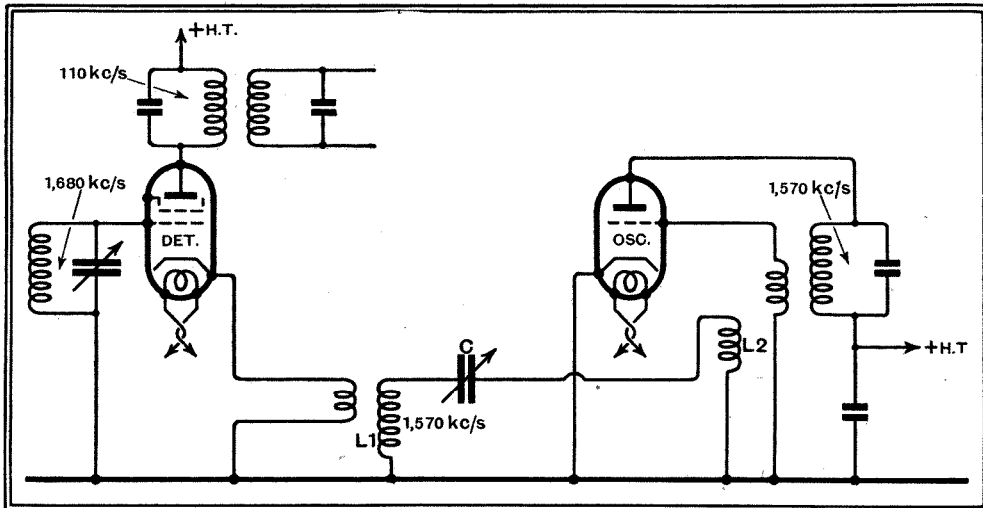

Fig. 3.—A method of oscillator coupling in which a tuned circuit L1, L2, C is used to avoid difficulty due to oscillator harmonics.

Resistance Tuning

A New Development

FROM the earliest days of wireless tuning has invariably been based upon the principle of balancing negative and positive reactances. The reactance of an inductance is proportional to frequency and is positive, while that of capacity is inversely proportional to frequency and is negative. If a coil and condenser be connected in series, therefore, the total reactance becomes zero for that frequency at which the inductive and capacitive reactances are equal. This is the condition of resonance, and it is obvious that the tuning may be varied by altering either the inductive or the capacitive reactance—that is, either the inductance or the capacity.

It is almost the universal practice to vary the capacity, and variable condensers are employed for this purpose. One of the greatest objections to the system is that both the efficiency and the selectivity vary greatly at different frequencies, so that it is not feasible to obtain a single wide tuning range. If a wide tuning range be required, it must be obtained by dividing it into a number of small ranges, for each of which a separate coil is necessary. Even then, both efficiency and selectivity vary greatly with any reasonable number of ranges when the total band of 150-1,500 kc/s must be covered.

One method of overcoming the difficulty lies in the particular application of the superheterodyne principle known as single-span tuning, and with this it is readily possible to cover the 150-1,500 kc/s band in a single sweep with constant efficiency and selectivity. This is not the only available method, however, for the June issue of the Proceedings of the Institute of Radio Engineers contains details of a new system of tuning due to S. Cabot and known as resistance tuning.

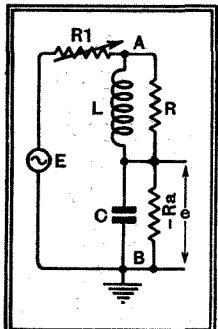

Fig. 1.—The fundamental circuit for resistance tuning is shown here. The resistance R_1 controls the tuning and the negative resistance $-R_a$ is actually a dynatron valve.

It is possible, however, to combine a fixed in-

ductance and a fixed resistance with a fixed capacity and a fixed negative resistance in such a way that the combination behaves as a negative resistance the

THE principle of reactance tuning, usually by means of a variable condenser, is so widely accepted as the only practicable method that the development of an entirely new system comes as something of a shock. A tuning system which claims outstanding advantages over the older method is described in this article. The system is known as resistance tuning since the customary variable condenser is replaced by a variable resistance.

value of which is greatly dependent upon frequency. This being the case, the combination can be opposed by a positive resistance so that at one particular frequency, which depends upon the value assigned to the positive resistance, the total resistance is zero. Tuning, therefore, can be carried out by the simple expedient of varying the positive resistance.

The fundamental circuit of the system is shown in Fig. 1. The resistance R_1 is variable and forms the tuning control, while the combination of L , C , R , and $-R_a$ forms the effective negative resistance variable with frequency. The input signal is injected in series with the circuit, and is represented by the generator E , and the output e is taken across C and $-R_a$.

Circuit Values

If R be made numerically equal to $-R_a$ and $L = R^2 C$, it can be shown mathematically that the impedance of the system is at a minimum for a frequency $f = 1/2\pi\sqrt{LC}$ when R_1 is zero. When R_1 is made equal to R , however, minimum impedance occurs for zero frequency. It will be seen, therefore, that tuning can be varied from zero frequency to a frequency determined by the LC product by altering R_1 between the limits of R and zero.

No special difficulty is attached to the attainment of components having the requisite values for L , C , R , and R_1 , but a negative resistance for $-R_a$ is not so readily available. It is possible, how-

ever, to press a dynatron valve into service for this purpose, and a suggested circuit for a two-stage amplifier is shown in Fig. 2. The first valve is a dynatron and replaces the resistance $-R_a$ of Fig. 1. Actually, any screen-grid valve possessing good dynatron characteristics may be used. The second valve is a pliodynatron, and very few types are available. It may, however, be replaced by a screen-grid amplifier followed by a dynatron.

The cathode biasing resistances R_1 control the values of the negative resistances introduced by the valves, and the two variable resistances R are for tuning. In practice, of course, these resistances would be ganged and operated by a single control knob. With suitable valves very high amplification can be secured and a wide

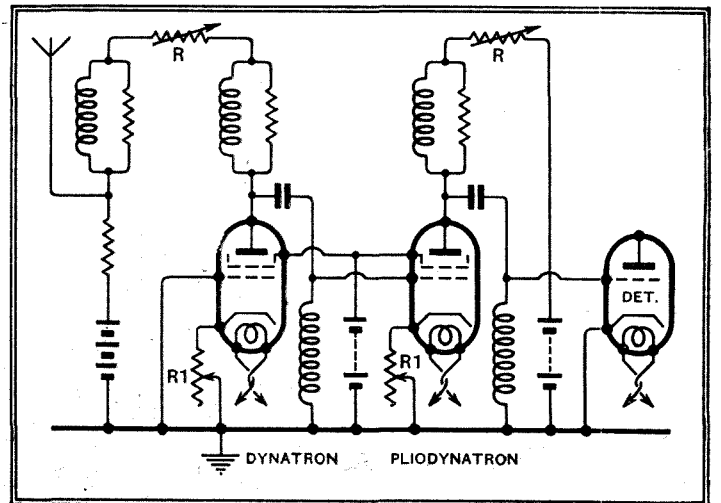

Fig. 2.—The suggested circuit diagram for a two-stage amplifier embodying two resistance-tuned circuits. The pliodynatron can be replaced by an ordinary screen-grid stage and another dynatron.

tuning range. Moreover, the selectivity is constant provided that the resistance of the coils does not vary with frequency. The coil resistance is not a constant, however, so that the selectivity does vary somewhat. Compensation for this may be obtained, however, by linking the resistances R_1 to the tuning resistances R .

The values of components are all closely inter-related, and it can be shown that the highest frequency to which it is possible to tune is set by the minimum negative resistance which it is possible to obtain.

Although the system is hardly yet developed to a sufficient degree to be applicable to general broadcast reception, it is of particular interest as affording for the first time an alternative to the accepted practice of reactance tuning. Considerable development, particularly in the field of valves, will probably be needed before the method can become of wide application, but the new principle clearly shows that even in such an apparently stabilised section of technique as tuning finality has not yet been reached.

Electrical Interference

The Problem of a Definition

By A. MORRIS, A.R.C.Sc., M.I.E.E. (Post Office Engineering Department)

WHETHER the suppression of electrical interference comes about as a result of legislation or voluntary action, by national or by local regulations, the first necessity is to define what degree of radiation from electrical plant constitutes interference with broadcast reception. In this article some of the problems associated with arriving at a definition are discussed.

THE interference from any item of electrical plant can be mitigated by the adoption of appropriate measures. This is not an overstatement of the present position, although it certainly raises the issue as to why, in such circumstances, a settlement in respect of the subject of radio interference has not yet been reached. The answer to this query is readily furnished. The degree of mitigation which can be achieved is largely a matter of cost, and it is desired that only the minimum necessary sum of money shall be spent to meet the requirements of this matter. A solution of the economic question thus posed has not yet been arrived at, either in this or in any other country. Agreement upon the technical basis of such a solution, at least so far as its main features are concerned, is the outstanding problem of this subject.

Economic Considerations

In certain cases the necessary measures are simple, in others they are more complex. Thus, for many domestic appliances and light commercial apparatus a simple condenser type of suppressor is generally satisfactory; for heavy commercial plant the condenser-choke type of suppressor is advantageous, whilst for certain other classes of plant additional means, such as spark-quench circuits and screening arrangements, are desirable. For a moderate degree of suppression the cost, expressed as a percentage of the cost of the plant, probably varies but slightly from one class of plant to another. In general, however, the higher the degree to which the interference from electrical plant is suppressed, the more elaborate the means and the greater the cost, particularly for the "heavy" class of plant. In all cases, of course, the elements composing interference suppressors must be electrically adequate, whilst complete suppressors must embody normal protective features.

The usual type of condenser suppressor shunts the terminals of the interfering plant by means of two condensers in series, an additional condenser being employed for connection between their junction and the frame of the plant or the metallic sheath of the supply mains and thence to earth. Unless this latter condenser is of reasonably large capacity only a moderate degree of suppression will

be obtained. Considerations of safety to persons handling domestic items with un-earthed frames or plant only nominally earth-connected necessitate this condenser being of small capacity. The capacity should not exceed 0.01 microfarad; in some cases such a limitation results in poor suppression unless the additional use of choke coils is resorted to. The use of chokes may increase the cost considerably; for this reason it may not be economical to utilise the fullest possible degree of suppression.

Technical Aspects

From the foregoing it will be evident that an important aspect of the subject is that of the minimum degree of suppression of the interference from any particular item of electrical plant which can be regarded as satisfactory. A more fundamental aspect, however, is the general degree to which radio reception will ultimately be immunised from electrical interference. Actually, these two aspects are interdependent, although the latter is considered to be the principal concern of the broadcast listener, whilst the former is regarded as the exclusive concern of the electrical plant manufacturer.

The comfort with which a broadcast programme is heard is determined by the relative strengths of the programme and

the extraneous noise, i.e., by the signal/noise ratio of the transmission. The magnitude of the signal/noise ratio at a receiving site will depend upon a number of factors. For a definite strength of radio noise the signal/noise ratio will depend directly upon the field strength and depth of modulation of the broadcast transmission.

Omitting consideration, for the time being, of methods of expression and of measurement of radio interference, it may be mentioned that a definition, in appropriate numerical terms, of "essentially interference-free" reception at a receiving site has already been proposed in this country. This definition states the wave range and minimum strength signal to be protected as well as the extent of the protection to be afforded. At the recent (June, 1934) Paris Conference of the International Electro-technical Commission this definition was accepted in principle, when it was agreed that: "Taking into account exclusively the interests of broadcasting, it is desirable if interference-free reception is to be obtained that the level of the interference (measured in accordance with methods to be defined) should be lower by 40 decibels than the mean level of a signal produced by a field of 1 millivolt per metre, modulated 20 per cent."

The definition states what has fre-

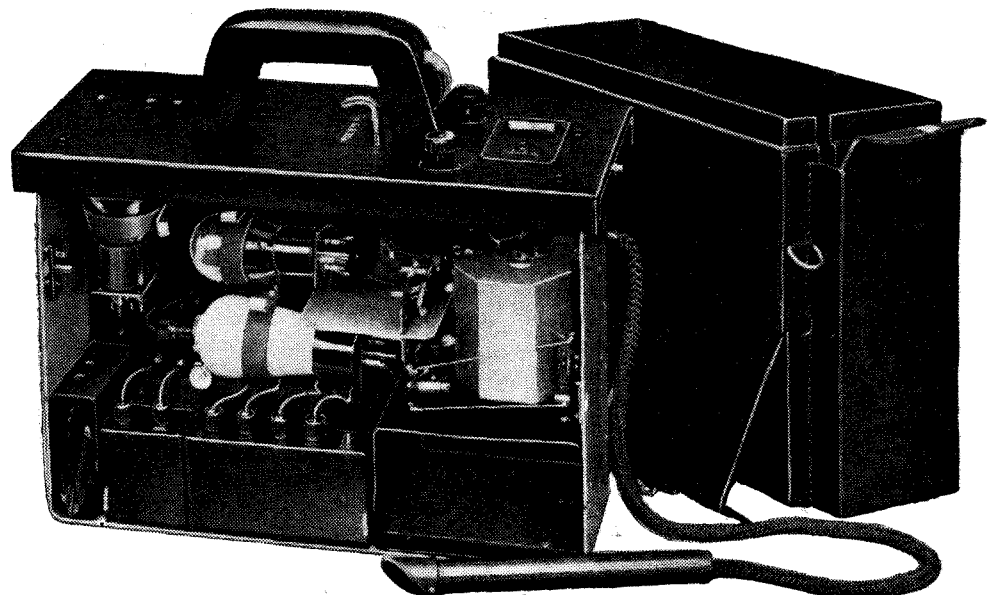

A PORTABLE INTERFERENCE DETECTOR. An instrument developed on the Continent by Siemens. With this equipment sources of disturbance can be located and their relative intensity measured.

Electrical Interference—

requently been referred to as the "desirable objective" in contra-distinction to what may be regarded as the "economic objective." This latter will represent the degree of amelioration to be actually afforded to the listener; it has yet to be stated in concise numerical terms.

British Method of Expression and of Measurement

The adoption of a suitable method (including the technical terms to be employed) for the expression of radio interference and of appropriate equipment for its measurement are necessary for the purpose of technical pronouncements on the principal aspects of this subject.

It may be assumed that the interference caused by electrical appliances arises from variations of electrical potential in the space surrounding the appliance. The components of such variations may be regarded as distributed in a substantially uniform manner over the whole range of radio frequencies. The root-mean-square value of these component vertical potential gradients, within a selected band of radio frequencies, can be measured by suitable apparatus.

The technique proposed by the British Post Office for use in this country is based upon the foregoing considerations and upon the use of equipment of the type normally employed for the measurement of the field strength and depth of modulation of radio transmissions. By means of this class of apparatus interference-producing electric fields, i.e., "noise fields," are measured and referred to in terms of their "equivalent field strength," the numerical expression being in microvolts per metre. This technique can be correlated with the previously mentioned definition of interference-free reception, the requirements of which will be met by noise fields of strength not greater than 2 microvolts per metre.

A number of different methods for the expression of radio interference are in use; these are to be respectively preferred in accordance with the method of measurement adopted.

The French radio noise-measuring apparatus enables a comparison to be made between two audio-frequency quantities, radio interference being thereby referred to in terms of the level of its audio effect relative to the level of the audio effect of a radio field of stated field strength (1 millivolt per metre) and modulation (800 c.p.s., 30 per cent.). The method is somewhat similar to one employed in America, except that the numerical expression is in Népers. Apparatus suitable for such measurements has been described in Publication 407 de l'Union des Syndicats de l'Electricité.

The German interference-measuring apparatus enables a measurement to be made of the electromotive forces produced by interfering electrical plant regarded as radio-frequency generators. By its use radio interference may be expressed in terms of the radio-frequency voltage

generated by the item of plant, either (a) on the mains, supplying current to the item, or (b) in an aerial system of stated dimensions located at a stated distance from the item. The numerical expression is in volts.

Apparatus suitable for such measurements has been described by W. Wild in an article appearing in *E.T.Z.* on February 16th and 23rd, 1933. This type of apparatus has been adopted by the Verein Deutsche Elektrotechniker Sub-committee of the German Commission on Broadcasting for the determination of the frequency spectra of interfering sources.

By means of the radio noise-measuring apparatus of the National Electric Lighting Association of America, radio interference can be measured by comparison of its audio-frequency effect with that of a radio-frequency voltage modulated to a stated depth (50 per cent.) by a note (400 c.p.s.) of a stated frequency. In accordance with this method, radio interference is referred to in terms of the strength of an equivalent radio signal modulated in accordance with the comparison voltage. The numerical expression is in modulated microvolts per metre.

Apparatus suitable for such measurements has been described in N.E.L.A. Publication N. 32 of January, 1933.

In the interests of purchasers of electrical plant, and in order to facilitate export and import business, international agreement upon the technique variously employed is desirable, at least in principle. Such agreement would be for the purpose of correlation with the requirements of the definition of "interference-free reception." At the I.E.C. Conference previously referred to, the technique employed in various European countries was fully discussed, and it was decided to carry out tests on the British, French, and German equipments at Berlin in the autumn for the purpose of determining the extent to which correlation of the three methods is possible. Provided this can be done, it should be possible, subsequently, to agree upon standards of suppression, and, at the same time, leave the various countries free to utilise the apparatus which they have respectively developed.

Conclusion

It has been previously stated that the desirable objective, as interpreted from the I.E.C. definition of interference-free reception, is the reduction of noise fields in the immediate neighbourhood of receiving sets to a value not exceeding $2\mu\text{V./metre}$, when expressed in terms of the British technique. The general degree to which radio reception can be immunised in practice, i.e., the economic objective to be realised, will probably necessitate stronger noise fields being tolerated. A French regulation appears to prohibit noise fields in excess of $15\mu\text{V./metre}$ at receiving sites. The complete regulations were evolved to meet the urgent requirements of the law. From their general form it appears probable that the figure of $15\mu\text{V./metre}$ is not based upon a very ex-

tensive or complete economic study of this subject.

The table gives signal/noise ratio criteria of the reception resulting from noise fields ranging in value from 2 to 20 $\mu\text{V./metre}$.

SIGNAL/NOISE RATIO CRITERIA OF RECEPTION.

Signal Field 1 millivolt/metre, modulated 20 per cent.					
Noise field, $\mu\text{V./m.}$..	2	5	10	15.0	20
Signal/Noise, voltage ratio	100	40	20	13.3	10
Signal/Noise, ratio in decibels	40	32	26	22.5	20

Irrespective of the nature of the political settlement of this subject, i.e., whether by national regulations or by voluntary action, it will be necessary to state in explicit numerical terms just exactly what is required of electrical plant from the interference aspect, in order that manufacturers may ensure compliance with the economic objective envisaged for the listener. This may be accomplished in accordance with the method proposed by the author, whereby, in terms of the British technique, the noise field set up by any item of plant, at a certain distance from it, is limited to the same numerical value as the noise field to be agreed upon as representing the economic objective. This method involves the setting up of a series of graded distances appropriate to respective classes of plant; this would be based upon distances from receiving sites at which, in the average case, such plant would ordinarily be operating. For most domestic items of plant this distance would be of the order of a few yards. For commercial plant and industrial systems, however, which usually operate in situations remote from receiving sites, the distance would be greater; radio reception within a short range of such plant being an abnormal rather than a general requirement. Any difficulty which might be encountered in effecting measurements at relatively great distances from such plant could be overcome by measurements made at shorter distances, but suitably corrected in accordance with a knowledge of the attenuation with distance of the interference from such plant.

The preparation of a Specification for the performance of "radio-interference-free" electrical appliances has been envisaged as an integral part of the British method of dealing with this subject. The framework of such a Specification has been prepared. It indicates various arrangements of components suitable for use as interference suppressors, and gives the standard ratings and safety requirements for such components. In addition, it defines, in accordance with the method outlined above, the maximum amount of radio interference permissible from electrical appliances, although the appropriate numerics cannot be fixed until agreement on the aspects previously referred to has been reached.

A cheap testing set for use in factories as a check on the performance of plant is also referred to in the Specification, but a detailed design is outstanding.

The Art of Ganging

VIII.—Difficulties Encountered in I.F. Circuits

THERE is nothing essentially difficult about the process of adjusting the intermediate frequency circuits of a superheterodyne, and it is chiefly a matter of patience. Except in the case of the couplings, all adjustments are carried out for maximum signal strength, and it is strongly recommended that some form of visual tuning indicator be employed as an indicator of resonance, since it permits far greater accuracy to be obtained unless the operator is highly skilled. The chief trouble that is likely to occur is that one of the trimmers has to be pushed to the limit of its travel in one direction, whereas one of the others may be at its limit in the other direction. This is invariably due to unsuitable values of stray capacity in the different circuits, and as far as possible it is a wise plan to try to equalise the external stray capacities as far as possible. This trouble occurs usually when employing those types of I.F. transformers in which the movement of the trimmers is limited in order to make it impossible to operate them far from the correct frequency. Other types of transformer have a wider range of capacity available in the trimmers, and the trouble rarely occurs with these; on the other hand, it is possible to adjust them to resonate at a frequency widely different from that intended by the designer of the receiver, so that an additional check on the frequency becomes necessary.

Stray Capacities

In cases where accurate trimming is impossible owing to the limitation of travel of the trimmers, a little thought will usually soon show the cause of the trouble. That trimmer which requires the least capacity is obviously fitted to a circuit which has the highest external stray capacity. This external capacity must be reduced if possible, and so the circuits of this coupling must be examined for causes of high stray capacity. It is to be expected that the anode circuits will in general have higher stray capacities than the grid circuits, because of the construction of the valves, but this alone should not seriously affect the trimming. It will usually be an anode circuit, however, in which the trouble is located, and the most probable cause lies in the screening of an anode lead. An excessively long screened lead, or the use of an unsuitable type of material, will normally be found to be the cause of the trouble, and in this connection, it should be remembered that the remarks in the section dealing with straight

MOST of the untoward effects met with in an I.F. amplifier are essentially the same as those encountered in the H.F. stages of a straight set, but they usually assume a different magnitude. The commonest difficulties in the adjustment of an amplifier are discussed in this article, and it is shown how they may be overcome.

sets about the choice of screened sleeving apply with equal force to the I.F. circuits of a superheterodyne.

Although the anode circuits usually have the highest stray capacity, an exception may be found in the case of the grid circuit of a triode power grid detector. The effective grid-cathode capacity of this valve depends very largely upon the anode circuit load impedance, and is smaller the larger the value of the anode-cathode

a result, it may sometimes attain such a value that accurate trimming of the grid circuit is not always possible. Fortunately, this is not of very great importance, for when conditions are such that this particular capacity is high, the damping imposed on the tuned circuit is also heavy, and the trimming is so flat that the slight degree of mis-tuning, which may be inevitable, does not appreciably affect the performance.

Many modern receivers, of course, employ a diode detector, with which anti-phase feed-back does not occur, so that this trouble is now less evident than formerly.

In the case of I.F. transformers with a limited movement to the trimmers, to which the above remarks chiefly apply, the question of checking the intermediate frequency hardly arises, for the reason that it is not usually possible to adjust the trimmers for resonance at a wrong frequency, or if they are so adjusted due to excessive stray capacities throughout, the trimmer movement is hardly sufficient to rectify matters. Checking the intermediate frequency, however, is important in most cases, and it is easily done by making use of what is otherwise an undesirable phenomenon—second channel interference. (To be concluded.)

Radio Receiver Measurements. Roy M. Barnard, B.Sc., A.M.I.R.E. (Chief Inspector of Broadcast Receivers, Standard Telephones and Cables, Ltd.). Pp. 116, with 55 illustrations and diagrams. Published by Hiffe and Sons Ltd., Dorset House, Stamford Street, London, S.E.1. Price 4s. 6d.

Although with the apparatus now available figures for overall sensitivity, selectivity and fidelity are rapidly obtainable; there are many pitfalls for the unwary which may easily lead to inaccuracies and misinterpretation of the results. It is the knowledge of these difficulties which has enabled the author to produce a manual which is something more than an instruction booklet for the operation of signal generators.

Chapters are devoted to the ganging and adjustment of superheterodyne and straight receivers preparatory to the measurement of the principal characteristics of sensitivity, selectivity and fidelity, and detailed instructions are given for determining features such as the performance of automatic volume control, harmonic distortion, etc.

The book has been written essentially for those engaged in laboratory and service work, and the tables at the end of each chapter summarising the various operations in their correct sequence should greatly expedite the work involved in compiling precise data of performance.

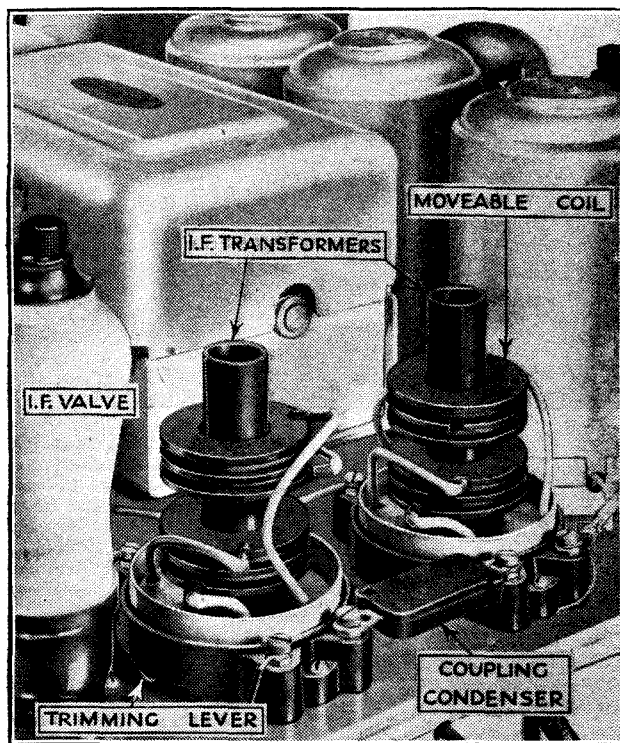

An I.F. amplifier in which two I.F. transformers, shown with their screens removed, are coupled by a condenser to obtain high selectivity.

by-pass condenser. It is not usually practicable to use a larger by-pass condenser in a superheterodyne than in a straight set on account of the difficulty of avoiding an excessive high note loss. As the frequency of operation is lower, however, the reactance of the condenser is higher, and consequently the input capacity of the detector is much higher than in a straight set. As

News of the Week

Current Events in Brief Review

At Marconi's Birthplace

MARCHESE MARCONI is himself designing the 50-kilowatt broadcast transmitter which is to be erected next year at his birthplace, Bologna, exactly forty years after his original invention.

Wireless on Gliders

WIRELESS is playing a prominent part in the annual gliding competitions now being held in the Rhön district, Germany. The gliders are equipped with a short-wave receiver and by means of a small ground transmitter are given instructions as to air currents and relative positions of the competitors. Onlookers are able to follow the proceedings by means of public address equipment.

"S.B." in France

IT is interesting to observe how French broadcasting under State ownership is slowly conform-

One Transmitter—One Licence

THE Czecho-Slovakian Postmaster-General has informed the Association of Prague Radio Amateurs that it is against the law to possess more than one transmitting installation per licence. Unlicensed sets will be seized.

Lower Power for Tour Eiffel

THE Eiffel Tower station is to remain on the long waveband for a few more months, according to the French Postmaster-General, replying last week to a complaint that the "Tour" interfered with Radio Paris. The P.M.G. explained that the necessary alterations in the plant to reduce the wavelength to 206 metres in accordance with the Lucerne Plan, would occupy a considerable time. By way of compromise the power is to be reduced after 7.30 p.m. from 15 kilowatts to about 8 kilowatts.

Fewer German Listeners

THERE is still an ominous decline in the German licence figures, the total on July 1st being 5,359,480. i.e., 41,940 fewer than a month earlier. There is always a seasonal decrease during July, but this year's drop exceeds those of previous years by a considerable margin.

Licences for Car Radio

REPLYING to a question in the House of Commons last week, the Postmaster-General, Sir Kingsley Wood, said that a wireless licence covered the regular use of wireless receiving apparatus at the address shown on the licence and also the occasional use by the licensee (or a member of his household) of a portable receiving set at another place, whether in a house, or in the open air, or in a motor car. The licence must be carried by the person using the portable set.

The concession in regard to portable sets did not cover the use of

For 5-Metre Enthusiasts

DR. R. G. BLOOMFIELD (G5MG) is transmitting tests on 5 metres every Sunday at 10 a.m. and every Monday at 10.55 p.m. until the end of September. Quite a considerable range of transmission is expected, as the station is situated high up at Southgate, London, N.

Reports should be sent to 34, Morton Way, London, N.14.

A Visit to Germany

A PARTY of wireless and television enthusiasts leaves London on August 18th for Berlin, to see the German Radio Show and, by special arrangement, to pay visits to various works and other places of radio interest. A few vacancies still exist, and anyone interested is invited to apply for full particulars to Mr. R. W. Corkling, 19, Bassingham Road, Wembley.

A Telephony Contest

WHAT is believed to be an entirely new type of amateur transmitting contest is being run by the Radio Society of Great Britain from October 1st until March 31st of next year. It will be open to telephony stations only, and cash prizes will be awarded to the two operators who cover the longest distances.

The 21-metre amateur band only will be used and high power will be strictly forbidden. In fact, no entrant will use more than 10 watts input.

U.S. Radio Control

ALTHOUGH all radio and cable communications in America were taken over by the new Federal Communications Commission on July 1st, the change is being carried out very slowly. According to our Washington correspondent, all the two hundred or more members of the old Radio Commission staff are continuing in their original posts for at least two months. The rules and regulations of the Radio Commission are being maintained and it is now doubtful whether any radical alterations in policy will follow during the next two months. The *status quo* will continue in broadcasting for a long time.

Municipal Broadcasting Station

SHALL New York City's municipal broadcasting station, costing about 38,000 dollars a year to operate, be maintained? This problem is being considered by the municipal authorities who are discussing whether special announcements might in future be broadcast by other local stations.

WNYC, the station in question, is one of the few in America which do not "sell time." Several commercial interests have offered to purchase the station.



TAKING UP RADIO. A scene at the Army Vocational Centre, Thornhill, Aldershot, where soldiers are equipped for civilian tasks on leaving the service. The picture shows a typical wireless class learning the "mysteries" of public address systems.

ing to B.C.C. standards. One indication is the spread of "S.B." programmes. Among these are the daily talks between 6 and 6.30 p.m. and the performances of the French National Orchestra.

It has been decided to reduce the number of gramophone broadcasts which formerly provided the main fare at many of the smaller stations.

5-Metre Tests at Malvern

REPORTS of 5-metre reception at over fifty miles were received as a result of the tests on the Malvern Hills, Worcestershire, on Sunday, July 15th, already referred to in *The Wireless World*. The transmitters were G5FI, using telephony, and G6YJ, using I.C.W. Both stations employed *The Wireless World* Ultra-Short Wave receiver with great success.

Record reception was achieved by a station in the Cotswold Hills, more than fifty miles away. Many reports were received within this radius, although the transmitter power was only 4 watts, drawn from dry batteries.

A Grievance

A STRIKE at the local radio station on the 12th of February last having deprived him of a day's broadcast, a Burgundy listener recently refused to pay more than 49,863 francs out of the 50 francs radio tax. He had deducted one three-hundred-and-sixty-fifth of the sum. It is understood that the State officials, while admiring his arithmetic, refused to grant a licence.

Eager Radio Students

WHEN the Birmingham Central Technical College recently announced two radio courses lasting two and five years respectively, there was a deluge of enquiries. According to Mr. Gordon Baynton in an address before the Birmingham Radio Luncheon Club last week, so many youths in a certain factory applied that, if all had been allowed to take the courses, it would have been necessary to shut down the works two-and-a-half days a week.

The courses open on September 24th.

a wireless set which was permanently fitted in a motor car. A separate licence must be obtained for such a set and must be carried in the car. These rules had received considerable publicity, and he had no reason to believe that there was any extensive failure to comply with them.

Fire and Flood

RADIO-AGEN must surely be Europe's unluckiest broadcasting station. Three years ago it was destroyed by flood, and its owners, the General Council of Lot-et-Garonne, took the opportunity to build a better transmitter. On the night of July 7th-8th last, a fire broke out which in a few minutes entirely destroyed the studios, transmitter, and the offices.

It is considered unlikely that Radio-Agen will be rebuilt. The district will be adequately covered under the Ferrié Plan by a powerful transmitter at Toulouse and a local studio at Agen.

BROADCAST BREVITIES

By Our Special Correspondent

The Droitwich Comedy

THE secretiveness of the average B.B.C. engineer is a by-word at Broadcasting House. To get information from a member of Mr. Ashbridge's department is as easy as squeezing pips from a banana.

This is what makes the Droitwich situation so irresistibly funny. Frantically anxious to test the new station at full power with full modulation, the engineers are at the same time dogged by the fear that the general public may suspect that there is something in the air.

"Please Don't Listen"

This attitude, when dealing with a 150-kilowatt transmitter, is an impossible one.

In the old days the motto was "Please don't do it"—the reference being to oscillation. Now it seems to be: "Please don't listen."

Why the Mystery?

If the B.B.C. would issue regular official statements regarding the performance of this new station, which has been built with listeners' money, the "mystery" would be dissipated, and the ether after midnight would not be cluttered up with the whistles of the inquisitive.

Not a Failure

At present the silence of the Engineering Department is a challenge to every listener who takes a serious interest in broadcast transmission.

Those who have listened are aware that modulated signals can now be heard nearly every night between 12 and 3 a.m.

The quality is impressively good, which makes it all the more astonishing that no official information should be vouchsafed to the public. If the station were a failure it would be a different story.

Film Strips Broadcast

MAE WEST'S popular slogan may be heard on the loud speakers of England on August 8th. This will be on the occasion of a second edition of "Picture People"—the feature inaugurated in May last when famous film artists were heard in excerpts from well-known films. The selections were broadcast from the actual film strips.

Clayton Hutton, who is again the compiler, will introduce us to Mae West, Paul Robeson, Florence Desmond, Norma Shearer, Bing Crosby, Sophie Tucker, Grace Moore, Elizabeth Bergner, Evelyn Laye and Wallace Beery.

Autumn Talks

I HEAR that very ambitious plans have been prepared for the autumn B.B.C. talks, which are to be more comprehensive in range of subjects than ever before. There is to be a series by prominent Americans, whose addresses will be relayed direct from the U.S.A. on Sunday evenings. Another series will be devoted to India.

Reminiscences, household talks, technical talks, discussions, short story and poetry readings will be included in the syllabus.

Morning talks will start at the beginning of September, early evening talks in the third week of September, and the rest of the general talks and discussion group talks in the first week in October.

Announcers Have a Lot to Learn

ALTHOUGH it is twelve years since broadcasting started in this country there is no established technique of announcing, as appears to be the case in Belgium and France. Both countries have recently seen the establishment of schools for broadcast announcers.

In the syllabus of the Paris "Ecole du Micro," which I have been privileged to inspect, a quite elaborate course of study is laid out. The would-be announcer begins



QUEEN ELIZABETH BROADCASTS. Helen Menken at the microphone in the Carnegie Hall public studio of the Columbia Broadcasting System, New York. Her broadcasts have been given during intervals in the stage play "Mary of Scotland," in which she takes the part of Queen Elizabeth.

his studies with articulation, reading aloud, punctuation and the pronunciation of foreign terms.

Quick Thinking

He then proceeds to more ambitious studies, such as extemporary speeches and "simultaneous narrative." Under this latter heading come running commentaries on sports and pastimes, as well as high-speed art criticism at exhibitions, explanations of the fine points in legal processes and other mental gymnastics which might well terrify anyone not gifted with the perceptions of a Homer and the tongue of a Demosthenes.

Mr. Lloyd James' "Class"

At Broadcasting House the announcers' "class" is merely a happy informal meeting presided over by Mr. Lloyd James, with whom the announcers discuss pro-

nunciation posers and other pitfalls met with in the past week.

But perhaps if Messrs. Hibberd, Grisewood & Co. were called upon to describe national events and so-and-so's toilet soap in the same breath, they too might need special coaching. Perhaps not.

A Rhodesian Relay

ALTHOUGH the Niagara Falls have not been heard by wireless in Great Britain, we may hear the Victoria Falls, Southern Rhodesia, on August 5th, when the Livingstone Memorial there is to be unveiled by the Hon. H. U. Moffatt, nephew of Livingstone and ex-Prime Minister of Southern Rhodesia.

The proceedings will begin with a descriptive announcement, followed by an address by the Rev. Dr. James Grey, of the Presbyterian Church in Africa. The broadcast to National programme listeners will start at 1.50 p.m., the relay being carried out by means of the Anglo-South African Radio Telephone Service in co-operation with the General Post Office.

Broadcasting the Tidworth Tattoo

FROM Tidworth Arena on August 7th excerpts from the Southern Command Tattoo will be relayed to National programme listeners. The opening excerpt consists of Indian Club Swinging by a team of the 1st Battn. Royal Welch Fusiliers, accompanied by Massed Bands of the 7th Infantry Brigade and Royal Tank Corps playing "I'm for ever blowing bubbles," "Two Lovely Black Eyes," and "Three Blind Mice." At the completion of the exercise the team reforms and sings the National Air of Wales and leaves the arena to the Regimental Slow March, "The War March of the Men of Glamorgan."

The torchlight display by the 3rd Divisional Artillery will be accompanied by massed bands of the Royal Artillery and the 8th Infantry Brigade playing a selection from "The Passing of the Regiments."

B.B.C. and International Relays

WE give more than we get in the matter of international relays. I have just been studying a list of international relays in which the B.B.C. was concerned between May 8th and June 16th. In this period the B.B.C. provided forty-seven out-going relays, of which thirty were destined for North America, fifteen for distant countries such as Australia and Japan, and two for Europe. During the same period it accepted from abroad only five relays—four from Europe and one from Australia.

Are B.B.C. Programmes Best?

Presumably, the B.B.C. considers that its own programmes are best for home consumption, though *Wireless World* readers, who regularly listen to Continental stations, may hold a different opinion.

It is time that we had a relay of the new French National Orchestra, which, under its conductor, M. Inghelbrecht, is proving to be one of Europe's finest musical combinations.

Audio-Frequency

Part II.

TEST OSCILLATOR

Its Application to Component and Receiver Testing

By

M. G. SCROGGIE, B.Sc., A.M.I.E.E.

(Concluded from page 36 of last issue)

A PROMINENT engineer has stated recently that an audio-frequency oscillator and a valve voltmeter go a long way towards setting up the foundations of a radio laboratory. The construction of an oscillator was described last week, and details of an excellent valve voltmeter appeared in the issue of October 14th, 1931 and also in "The Wireless Engineer" of June, 1933. Both of these instruments have been designed to avoid the necessity for expensive apparatus to calibrate them. The valve voltmeters can be calibrated from a d.c. source and the oscillator needs no calibration at all (but it is recommended that the frequencies should be checked by a piano if available).

The principal object is to find out how an amplifier (or part of an amplifier) handles the wide range of frequencies which go to build up speech and music. Very often the ideal is equal amplification of all frequencies, which is usually called straight-line amplification; but sometimes the amplifier is deliberately intended to distort, so as to compensate for distortion elsewhere. This is the main

idea of the "Stenode," in which the a.f. amplifying part is given a rising curve to compensate for the falling off in the upper part of the scale due to sharp tuning circuits. Tone correctors of various sorts are now increasingly used to adjust the a.f. response to suit various conditions, such as the type of programme, the tendencies of the loud speaker or the characteristics of a gramophone pick-up.

It is very valuable to know just what one is getting, for an abnormal frequency curve often enables an obscure fault in construction or design to be spotted, whereas with mere listening it is possible to be unaware how much poorer the reproduction is than it need be.

The method of testing is simple enough

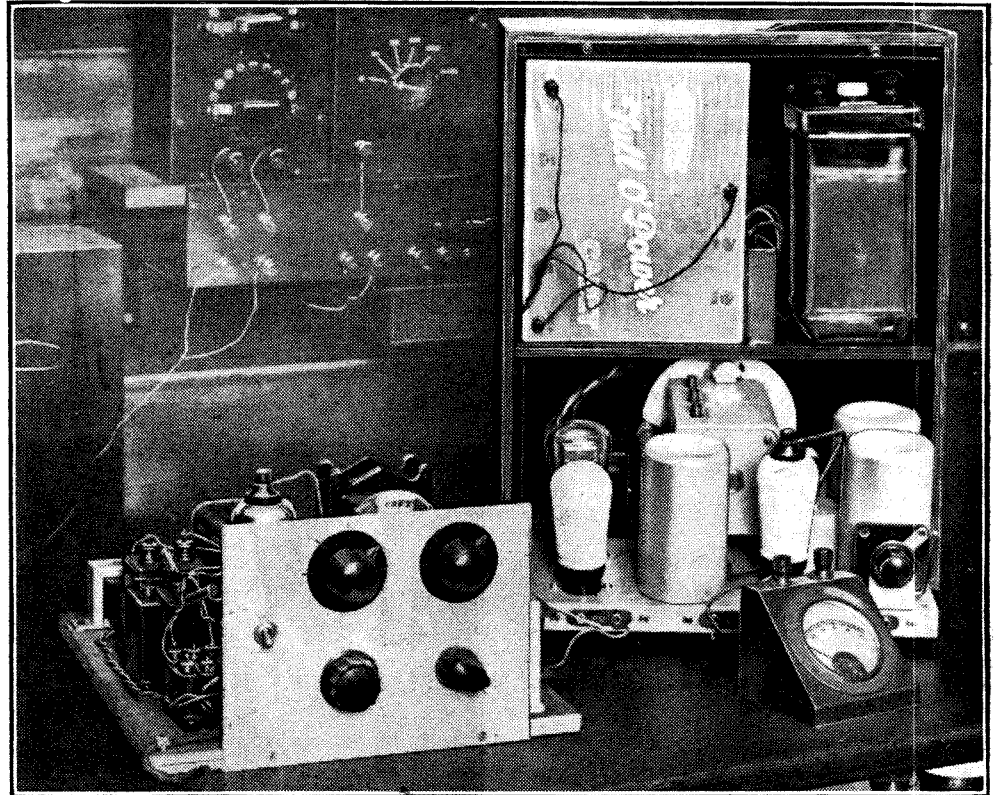

For measuring the frequency response of the L.F. stages of a receiver the oscillator may conveniently be connected to the pick-up terminals.

in essence—the oscillator is connected to the input of the amplifier and the voltmeter to the output, and it is noted how the voltmeter readings are affected by the frequency of oscillation.

But one has to be very careful to make sure that the conditions of test are as nearly as possible the same as those under which the amplifier normally works.

There are also some slight differences in method that are worth explaining.

Dealing with the latter first, the two principal schemes may be named *Constant Input* and *Constant Output*, which terms explain themselves.

If the equipment being tested is supposed to have something like a straight-line characteristic it does not much matter which method is used, and the choice will usually depend on convenience. Thus a feature of the oscillator is that when adjusted as described in the previous article the output is fairly constant at all frequencies for a fixed setting of the amplitude control chosen to give convenient output readings. So it is not absolutely necessary to switch the voltmeter over to the input, or to use an addi-

tional indicator to ensure a constant input. Thus the amplification at the various frequencies is proportional to the output voltmeter readings.

Output Metres

If, however, the characteristic of the amplifier is very much other than straight-line, this method is open to two criticisms. In the first place, most valve voltmeters have an unevenly divided (square-law) scale, and therefore cannot be read accurately over a very wide range of readings. Secondly, the reason for wanting an amplifier to have a markedly tilted response is usually because of some inequality in the input (such as high-note cut-off caused by extreme selectivity), which it is desired to neutralise so as to obtain a level output for feeding to the loud speaker.

Therefore, there is something to be said for the constant output scheme. The valve voltmeter—or other indicator—need not be calibrated at all. In fact, it is enough to rig up any odd valve with any odd batteries, give it enough bias to make it rectify after a fashion, put a milliammeter of sorts in the anode circuit, and so long as the pointer doesn't actually stick anywhere it is good enough to indicate constancy of output. Of course, this will not do if it is desired to measure the actual amplification at any frequency,

THIS oscillator, the construction of which was described in the previous issue, constitutes a valuable addition to the experimenter's test bench. The author deals in the concluding part of this article with a number of possible applications of the instrument and the precautions necessary in making measurements.

Audio-Frequency Test Oscillator—

but it is usually interesting enough to know the relative amplification.

To this end the oscillator amplitude control must be calibrated, as it is now a variable quantity instead of a fixed one. It is well worth doing this in any case.

At this stage an earnest plea is inserted that readers who have not already acquired the habit should lose no time in getting to think in decibels. At first these units may seem a trifle strange to anyone who has been brought up on voltage readings alone, but after a little while they become second nature. The whole business is explained in a previous article,¹ and enthusiasts may care to substitute the stepped decibel volume control described therein for the 10,000 ohm continuous control specified for the oscillator. The former being a 100,000 ohm control, all the values of resistance must obviously be divided by 10. Another article of value to those interested in response curves has appeared more recently.²

Amplitude Calibration

To go on with the matter of calibrating the oscillator amplitude control; a convenient method is to set the oscillator going at some moderate frequency such as 400 cycles, start with the control at maximum, and couple a valve or metal rectifier voltmeter to the output through some sort of additional volume control to reduce the signal to manageable proportions. The voltmeter need be calibrated over only a very small range of voltage. The oscillator control is first shifted round so as to reduce the reading to 80 per cent. of the original level (79.43 per cent., to be more correct). That is a drop of 2 decibels (1 decibel is hardly enough to worry about), and is marked accordingly on a suitable scale under the control knob. The external control is then used to restore the voltmeter reading to its first setting, and the process is repeated, given a 4 db. mark on the scale. In this way the oscillator control can be furnished with a decibel scale. To make it complete, it is probable that some amplification will be needed to keep up the voltmeter readings.

Having done this, the constant output test is very simple. The indicator—it need not be dignified with the name of audio-frequency voltmeter—is connected to the output of the amplifier, and a suitable deflection is given to it by adjustment of the oscillator control. Suppose the latter then reads 10 db. (from the "maximum" end). The other frequencies are switched in successively, and on each occasion the control is set to preserve a constant output indication; and the db. scale is read. Assume, for example, that at some particular frequency the pointer is found at 5 db. The output of the oscillator is then 5 db. greater than it was originally. But as the output at the far end of the amplifier is still the same it is clear that the amplifier itself is doing 5 db. less at that

frequency. Hence, by plotting db. readings against frequency, a drop in db. indicates a drop in amplification, which is just what it is meant to indicate.

Frequency Scales

While referring to the plotting of curves, it is perhaps as well to mention that the advantages of the equal-ratio scale of amplification apply also to the horizontal or frequency scale. At one time it was common for the part of the scale from 1,000 to 2,000 cycles to occupy just as much room as the part from 0 to 1,000. This is manifestly absurd when it is considered that the former represents one octave and the latter an infinitely large number of octaves. To give the various portions of the scale the same relative proportions to the eye as the corresponding sounds present to the ear it is necessary to use an octave scale, or, to give it another name, a logarithmic scale. Curve sheets for this purpose (described as "triple semi-log") can be obtained from most dealers in drawing-office supplies.

Having considered the broad principles of a.f. testing we can now look at some of the details with a view to conforming to the first requirement mentioned—that the conditions of test should be substantially the same as the actual working conditions of the apparatus being tested.

First, it is important to see that the

meter of the "grid" type is likely to load the grid circuit appreciably, or else to introduce capacity feed back by reason of its batteries. So such a measurement must be done with discretion.

If the voltmeter is connected in an anode circuit, say across a coupling resistor, it must not be conductive and so alter the operating conditions of the valve, nor must the d.c. drop across the resistor upset the readings. These difficulties are of progressively less weight as we move towards the loud speaker, and if the output is measured across the loud speaker itself, or across a resistance of an equivalent value which is usually not more than a few ohms, even a metal rectifier voltmeter is not likely to introduce appreciable shunting error. The rectifier meter is unsuitable for measuring distorted signals, however, as it is approximately linear—a square-law meter is desirable in these circumstances, being independent of harmonics, and the valve voltmeter which was described in the first article referred to is of this type.

Input Circuit Precautions

There is less difficulty about applying the input, as most input circuits are of many thousands of ohms, and therefore put no excessive load on the oscillator. *But it is important to provide a conducting path across the oscillator output terminals.* If this does not already exist a 0.1 megohm leak is usually suitable. It is

also necessary to see that the grid biasing arrangements are not upset.

If the test is made on a transformer or other coupling device, it should hardly be necessary to point out that there is not much sense in it unless it is carried out in conjunction with the appropriate valve. The oscillator will therefore practically always be applied to a grid circuit.

Where gramophone pick-up terminals exist the connection is simple enough. Sometimes the test voltage

required is very much less than the maximum available, and the slight hum voltage present may then be appreciable in comparison. In such cases it is advisable to tap off a proportion of the output by means of a potential divider.

Another point to watch is to keep the oscillator far enough away from intervalve transformers, etc., which might pick up a signal direct from the oscillator coils.

Throughout the foregoing it has been assumed that the object is a frequency response curve. Such a characteristic is a property of the apparatus itself. The other principal form of distortion—har-

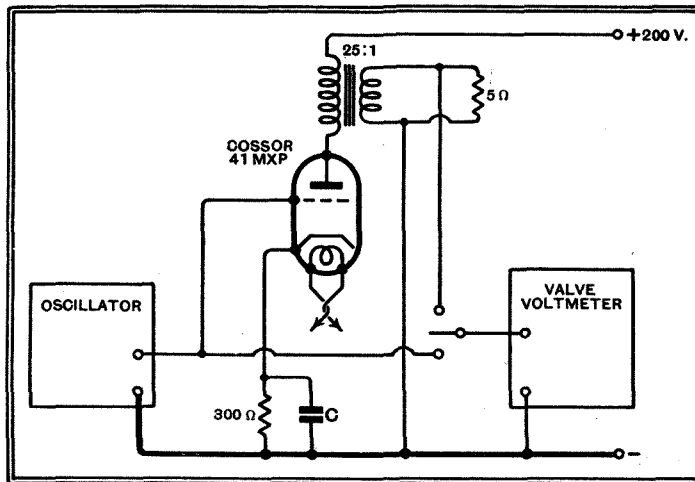

Fig. 5.—Connections of the oscillator and output meter for measuring the effect on the amplification of an L.F. stage due to changes in the value of the by-pass condenser C.

test apparatus does not introduce effects that alter the performance. To take an extreme example, suppose it is required to measure the amplification of a complete stage, between the grid of one valve and the next. And suppose also that one attempts to use even a high resistance metal-rectifier voltmeter (1,000 ohms per volt) to measure the output. That means that the grid-to-filament of the second valve is shunted by a few thousand ohms. In most cases it would be much the same as short-circuiting it altogether—there would be no appreciable reading, or at most a very small and wrong reading. Even a valve volt-

¹ "Why the Decibel?" July 22nd, 1931.

² "Loud Speaker Curves and Their Interpretation," November 25th and December 2nd, 1932.

Audio-Frequency Test Oscillator—

monic or overloading distortion—on the contrary is dependent on the intensity of the signal. In making the former class of measurement it is therefore necessary to make sure that the results are not being vitiated by overloading by keeping the signal at all points well below that level. But if information is sought on the overloading point a test can be made by increasing the input and noting when the output fails to show a proportional increase. This usually happens fairly suddenly consequent on a rapid increase in second harmonic distortion, but there may be considerable third harmonic distortion (in pentodes for example) which is not detected in this way. The overloading point may be at a lower signal level at some frequencies than at others; in fact, it is quite difficult to design an amplifier to handle as much power at 10,000 cycles as at 1,000.

Typical Measurements

By way of conclusion a simple example is given of how details in receiver design can be investigated by means of the oscillator. Quite a lot has been written from time to time on automatic grid bias systems and the undesirable effects which they cause unless properly arranged. Still, in this year of grace one sees bias resistors shunted (in a.f. circuits) by condensers of 1 or 2 mfd. Of course, in cheap manufactured receivers the designers do this quite callously with the object of reducing the hum which would otherwise call attention to the skimpiness of the smoothing circuits, knowing also that the bass response of the loud speaker-cum-cabinet is so non-uniform that it is

perhaps merciful to cut it off painlessly. But in equipment with aspirations after quality such blemish is inexcusable. Fig. 5 shows the circuit in which tests were made, and Fig. 6 depicts the results in graphical form.

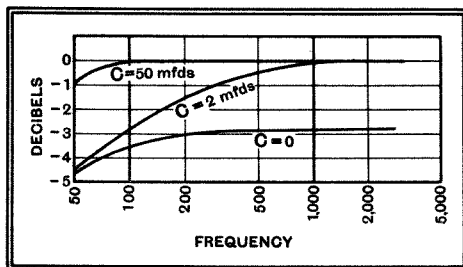

Fig. 6.—Results of measurements taken with the circuit shown in Fig. 5.

It will be noted that so far as a level response is concerned it is better to have no by-pass condenser at all than a small one though the amplification is lower. The falling off at low frequencies is not enormous in this case, but it can be much greater with certain parallel-feed circuits.¹

In much the same way it is possible to study the effects of various sizes of coupling condensers in parallel-feed systems, of by-pass condensers, of tone controls, of pentode limiter circuits, and many other things. Remember always that a peak of several decibels is not likely to sound very horrible, particularly if it happens to coincide with a hollow in the loud speaker response, but it may cause some part of the amplifier to overload prematurely and so limit the undistorted output.

¹ "Parallel-Feed Precautions," *The Wireless World*, February 17th, 1933.

New Lampex Receivers

FOR the coming season the Lampex Radio and Electric Co., Phantom House, Brewery Road, London, N.7, are producing a range of nine receivers and radio-gramophones. The prices throughout are exceptionally low and the receivers represent very good value for money.

The "Phantom Minx" three-valve battery receiver, for instance, at £3 19s. 6d., is housed in a walnut cabinet and is supplied complete with valves and batteries. The chassis is of the detector-L.F. type, and is also available in a higher-grade cabinet finished in walnut and bird's-eye maple at £5 5s. This model, known as the "Phantom Minx de Luxe," incorporates a permanent magnet moving-coil loud speaker.

For those who require a somewhat wider range the "Phantom S.G.3" (variable-mu H.F.-detector-pentode) is available at £7 7s. An equivalent receiver for operation from A.C. mains is known as the "Lampex S.G.3," the price being 7½ guineas. Both the latter receivers are supplied with moving-coil loud speakers.

The Lampex "Unifive" is a five-valve superheterodyne receiver designed to work either from A.C. or D.C. mains. Variable-mu H.F. pentodes are used in the frequency changer and I.F. stages, while the second detector is also a pentode, and the output

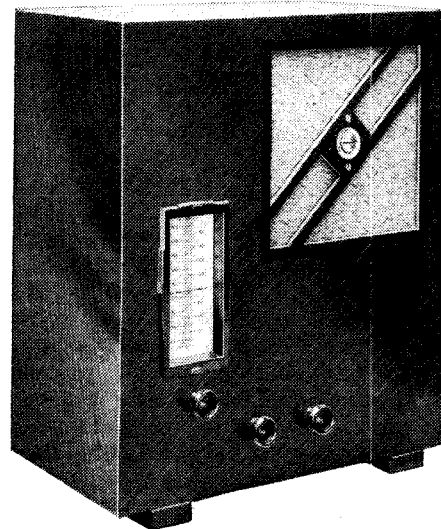

The new Lampex "Phantom Minx" battery receiver.

valve a double pentode. We have heard this receiver in operation, and the quality of reproduction given by the moving-coil loud speaker is really very good indeed. The price of the instrument in a walnut and maple cabinet is £10 19s. 6d.

The S.G.3 mains chassis is also available in radio-gramophone form with a B.T.H. motor at 15 guineas, and the "Unifive" chassis forms the basis of the "Lampex Universal Radiogramophone," which is supplied with dual loud speakers and a Collaro universal motor at 27 guineas.

Radio Amateur Call Book

WE learn that the summer edition of the Radio Amateur Call Book is now on sale in this country. It contains complete lists of amateur stations from Alaska to Zanzibar, together with classified lists of short-wave commercial, C.W. and telephony transmitters and other information of value to short-wave listeners.

Copies can be obtained, price 5s. 6d. post free, from Mr. F. L. Postlethwaite (G5KA), 41, Kinfauns Road, Goodmayes, Ilford, Essex.

A NEW TUNING DIAL

Two views of a demonstration model of the Naden-Galloway tuning device. The film is shown on an outrigger for the sake of clearness, but can be housed in a smaller space.

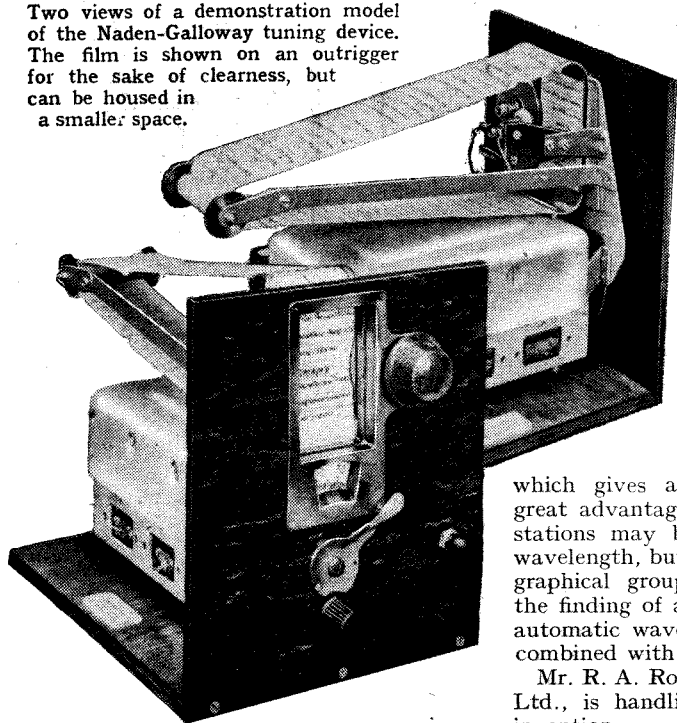

THE weakness of ordinary station-calibrated tuning dials is that they are too small for clear marking of channels. If, however, one does the obvious thing and merely increases the diameter of the conventional pattern, it becomes unsightly and generally impracticable.

An ingenious solution of this and several other tuning-dial difficulties has been devised by Messrs. J. H. Naden and C. H. Galloway, who have produced an arrangement where station names are printed on a flexible film, which gives almost unlimited space. A great advantage of this system is that the stations may be printed, not in order of wavelength, but in alphabetical order or geographical groups, thus greatly facilitating the finding of any desired transmitter. An automatic wave-change mechanism may be combined with the tuning system.

Mr. R. A. Rothermel, of R. A. Rothermel, Ltd., is handling the development of the invention.

Letters to the Editor

The Editor does not hold himself responsible for the opinions of his correspondents

No Name

I FEEL that everyone must be in sympathy with your editorial in the issue of July 13th, to the effect that makers should label their sets with their names in a clear and definite manner.

From the wording of the article, however, it seems to me it might be interpreted as an incitement to put the name on the front of the cabinet. I personally strongly resent it when other manufacturers endeavour to turn my drawing-room into an advertisement hoarding: for example, by putting the name of a piano or an electric fire on the front of it—and I should imagine many other people share this feeling.

It certainly would be interesting to have your editorial views as to whether you were advocating simply that the name should be clearly indicated rather than that you were advocating that the name should be displayed prominently on the front.

FRANK MURPHY,

Murphy Radio, Ltd.

Welwyn Garden City.

The Question of Quality

I HAVE read with interest your remarks on quality, forming the subject of your recent issues under "Editorial Comment."

As your remarks are confined to a practical technical journal, they do not reach the main listening public, whose voice should be the B.B.C.'s guidance to requirements. Until the public realise that quality is of paramount importance to the ultimate success of wireless reception and entertainment, and that any noise from the loud speaker will not do, I really do not think there is much hope for the B.B.C. to alter their present views.

I have realised that your repeated remarks deserve strong individual support from everyone who really cares about quality.

Malvern.

R. M. WINDSOR.

WE were greatly interested in the letter in your issue of July 13th from Mr. Robert Venables on the subject of quality, which agrees very closely with our own experience. Like him, we have for years been searching for the most faithful reproduction, and in the course of business we give many demonstrations to "the public."

He found among his difficulties "the desire of the listener to gratify the vanity of the set owner." We, naturally, find a contrary tendency; our listener is a potential buyer, and is usually looking for any faults he can find.

But we agree completely with Mr. Venables. The public *does* care—but it has few opportunities of judging. The most frequent comment that we find from musical listeners on first hearing our equipment is one of surprise—"I've never heard anything like this" is typical.

Points made by Mr. Venables which have also struck us noticeably are:—

1. "The public" are shy of high power until they have heard high power without distortion; after that they like it.
2. They hate "top" when it is shrill and

peaky, but thoroughly appreciate response up to 10,000 cycles if it is true.

3. The musical ones hate false bass and appreciate a real response at 50 cycles, but in this respect average taste is still lagging a little.

4. "Attack," or response to transients, is of immense importance, though as a rule the listener cannot describe just what he means in this connection.

Mr. Venables defines his set as "good but not perfect," with a reasonably flat response from 70 to 5,500 cycles—we wish others had his modesty. In our case the set itself is flat to ± 1 db. from 40 to 13,000 cycles, and the speaker has the advertised response curve; so that we are rather ahead of him. It is interesting, therefore, to find how closely his "public" and ours agree.

P. K. TURNER, M.I.E.E.,

Isleworth. Hartley Turner Radio, Ltd.

St. Elmo's Fire

DURING a severe thunderstorm on the night of July 10th-11th my staff reported that the stays of one of my wireless masts gave an excellent exhibition of what sounds like "St. Elmo's Fire," though unfortunately they did not call me to view it.

A reference book states that such a phenomena is rare in Britain, hence my reporting it to you, but both red and green "flames" were noticed, brilliant enough to light up and show every detail of an oak tree and a garage building some ten yards away, and giving a smell of "burning."

I might add that this mast is a steel one, insulated from earth, and with insulated wire rope stays, carrying an aerial used for transmitting.

A. M. HOUSTON FERGUS (Capt.),
Jersey, C.I. M.I.W.T.

A UNIVERSAL EVERYMAN SUPER

AN interesting adaptation of the highly successful Everyman A.C. Super (described in *The Wireless World* for December 22nd, 1933) has been produced by E. J. Forbat, of 28-29, Southampton Street, Strand, London, W.C.2. Ostar-Ganz high-voltage valves are used throughout, and their versatility is well demonstrated by the successful manner in which the slight modifications necessary have been introduced in the circuit.

Basically the set is unchanged in circuit design, but a double diode rectifying valve is employed for detection and A.V.C., and one or two minor modifications have been introduced into the power supply circuits. The set is, of course, of the universal type, working on either A.C. or D.C. mains, and employs one of the latest high-power double rectifying valves. Performance was found to be eminently satisfactory, and the modified set compares well with its prototype.

Circuit diagrams, etc., are available from the address given above, while parts for construction are obtainable from the Peto-Scott Company.

OCTACROS TEST RECORDS

THE frequency range covered by this series of constant-frequency test records is from 20 to 7,000 cycles. In all, forty-eight frequencies are provided on eight single-sided 10in. records. The records are cut at a

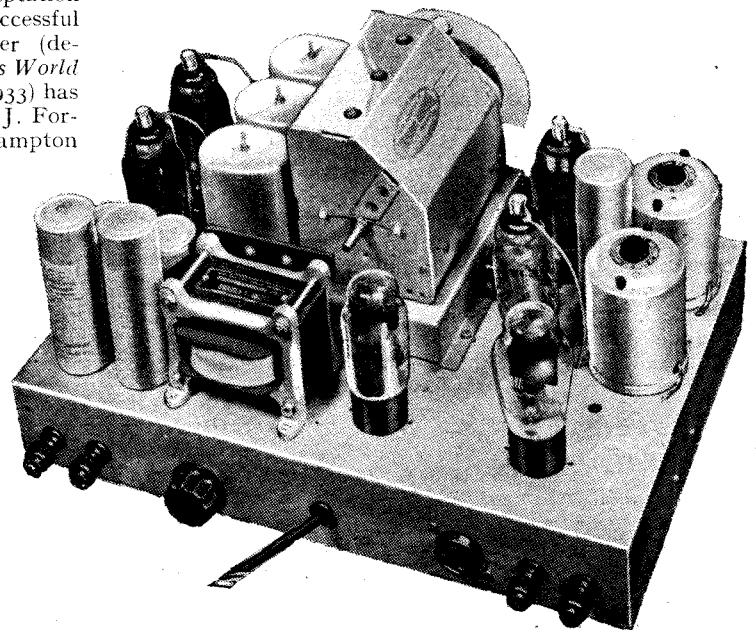

A slightly modified version of the Everyman Super, adapted to work with Ostar-Ganz Universal high-voltage valves.

speed of 78 r.p.m., and are of the constant-amplitude type, so that the voltage generated in the pick-up should be proportional to the frequency. It is claimed that the harmonic content is less than 5 per cent. above 100 cycles, and less than 10 per cent. below 100 cycles. In addition, there is a 1,000-cycle record giving a duration of playing of two minutes for general test purposes, and a special record for the adjustment of scratch filters with two bands of 5,000 and 6,000 cycles, each of one minute duration. Wireless experimenters will find many obvious uses for this series of records.

The price of each record is 2s. 6d., or £1 for the full set of ten. The records are issued by Synchronophone, Ltd., 24, Berners Street, London, W.1, and retail supplies are available from Leslie Dixon and Co., 218, Upper Thames Street, London, E.C.4.

New Apparatus Reviewed

Latest Products of the Manufacturers

MAGNAVOX "66" LOUD SPEAKER

BOTH in appearance and performance this unit is a welcome addition to the better class of quality reproducers which manufacturers appear to have neglected in the recent past.

One of the most noteworthy features of the performance is the high electro-acoustic efficiency, which is probably unsurpassed by any other cone-type moving-coil unit designed to work with a plane baffle. The 11-inch cone is of the seamless moulded type with a corrugated surround, and the speech coil is wound on a light former of laminated parchment and silk. A large-diameter centring spider of moulded bakelite material is mounted behind the cone.

We were particularly impressed with the excellence of the transient response, and the high flux density is largely responsible for this owing to the high degree of damping introduced. Individual instruments of the orchestra also stand out from each other, and there is very much less confusion of sound and generation of spurious frequencies on loud passages.

The output in the extreme bass from 100 down to 40 cycles is unusually uniform, but one or two subsidiary resonances were noted between 100 and 500 cycles. Above 500 cycles the response is smooth up to 5,500 cycles, and although an increase of output was noticeable in the region of 2,500 cycles, this resonance was much less pronounced than usual. There is a useful output up to 9,000 cycles, but there is a gradual tailing off above 6,000 cycles. The general effect, however, is very satisfying to the ear, and the reproduction is natural and unforced on all types of transmission.

The A.C. model tested includes a Westinghouse metal rectifier for the field, and costs £7 17s. 6d. The price of the equivalent

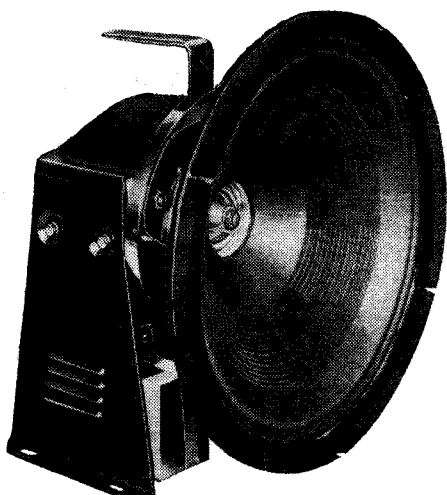

Magnavox energised moving-coil loud speaker, Model "66."

model for D.C. mains is £5 17s. 6d. Both units are supplied with an output transformer with tapplings for 2,700-4,000 and 5,500-8,000 ohms valves or 2,700-4,000 ohms triodes in push-pull.

The makers are the Benjamin Electric Co., Ltd., Brantwood Works, Tariff Road, London, N.17.

PIONEER GEN.-E.-MOTOR D.C. GENERATOR

R. A. ROTHERMEL, Ltd., Rothermel House, Canterbury Road, Kilburn, London, N.W.6, has sent in for test a specimen of the Pioneer Gen.-E.-Motor, a D.C. generator of American origin designed for use with car radio receivers.

Known as the model 5180-A.T., it is rated to give 180 volts output at 30 mA., and it is provided with an intermediate tapping at about 90 volts. It is designed for a six-volt input, and the stated current on full load is 1.94 amps.

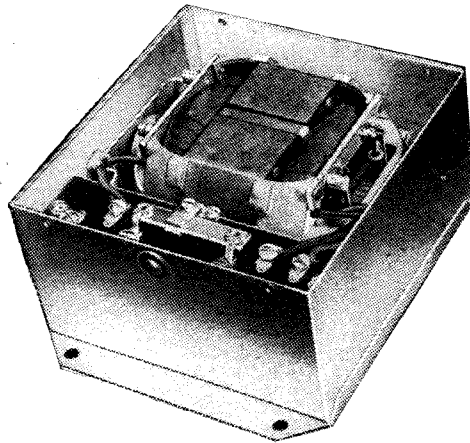

Pioneer Gen.-E.-Motor for car radio use, distributed by R. A. Rothermel, Ltd.

The complete unit consists of a miniature D.C. generator and a filter for smoothing out commutator ripple and any H.F. currents produced by the machine. The whole is housed in a sturdy metal case measuring 5 $\frac{1}{8}$ in. \times 5 $\frac{1}{8}$ in. \times 2 $\frac{1}{4}$ in.

The generator has laminated pole-pieces, a double-wound armature, and self-adjusting carbon brushes of generous size, and the machine is mounted in rubber bushes to damp out vibration and give silent running.

The input circuit is arranged for single-pole wiring, the case serving as the negative return. On the output side all H.T. leads are completely insulated from the case. Its performance is in every respect exemplary, it is mechanically silent, quite vibrationless, and, above all, gives a steady D.C. output free from ripple and H.F. interference. Indeed, so good is the filtering that we were tempted to try the machine with a battery-type set and using headphones for reception, which test it passed satisfactorily, for only a faint ripple was audible.

The results of our measurements are given in the accompanying table:—

Input at 6 Volts.		D.C. Output.			Efficiency per cent.
Amps.	Watts.	Current in mA.	Volts.	Watts.	
1.56	9.37	5	208	1.04	11.1
1.7	10.2	10	203	2.03	19.9
1.9	11.4	15	200	3.0	26.3
2.1	12.6	20	195	3.9	31.0
2.3	13.8	25	190	4.75	34.4
2.5	15.0	30	186	5.58	37.1
2.7	16.2	35	182	6.37	39.3
2.9	17.4	40	177	7.08	40.7

Apart from its use with car radio sets, the very compactness of the unit renders it par-

ticularly suitable for all portable work, such as public-address and amateur outdoor experiments. There are several other models available giving larger outputs at higher voltages.

The type 5180-A.T. costs five guineas, while one for a 12-volt input, and giving 250 volts D.C. at 50 mA., is available at £3 17s. 6d. All models can be obtained with or without the filter unit.

EELEX DUPLEX SHORT-WAVE COIL

SINCE last we tested and reviewed this short-wave coil (July 14th, 1933) a few minor improvements have been effected, although in principle it remains the same. The special feature of the coil is that it covers the whole of the useful part of the short waveband without switching, in place of which a reversible mounting is adopted, and in one position the coil covers a band of from 13.7 to 31.2 metres, and in the other from 28.7 to 53.2 metres, using a 0.00015-mfd. tuning condenser and one at 0.0003-mfd. for reaction control. The wave range can be extended to about 60 metres with an 0.0002-mfd. tuning condenser.

We found a small condenser in series with the aerial necessary to maintain oscillation over the longer of the two wavebands with the coil fitted to an orthodox short-wave set of the detector-L.F. type. One of 0.00005-mfd. maximum will suffice, and it will serve also to shift any blind spots that may appear with some aerials.

Even with only a quarter of this capacity in the circuit signals were of comfortable strength with but a single valve, which is

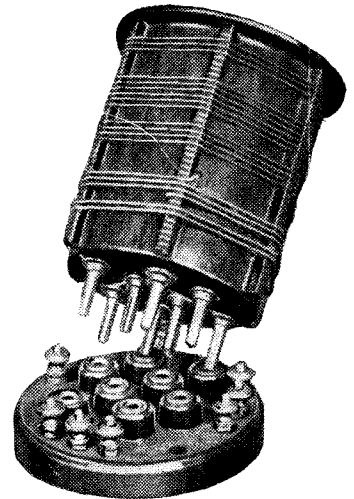

Eelex reversible Duplex dual-range short-wave coil.

indicative of good efficiency. Reaction is satisfactory throughout. An eight-pin base is supplied, and the connections so made that the idle windings are automatically short-circuited.

The new model will tune to a lower wavelength than the earlier samples, and the reaction winding is somewhat better proportioned.

The makers are J. J. Eastick and Sons, Eelex House, 118, Bunhill Row, London, E.C.1, and the price complete with base is 7s. 6d.

MODERATE COST—YET GARRARD QUALITY

in this New Unit for A.C. or D.C. Current

The Garrard U5 Universal Electric Motor, supplied complete with 12-in. plush-covered turntable and mounted on bronzed and lacquered motor plate, incorporating speed indicator and latest type automatic switch, ready for fitting. **67/6** complete

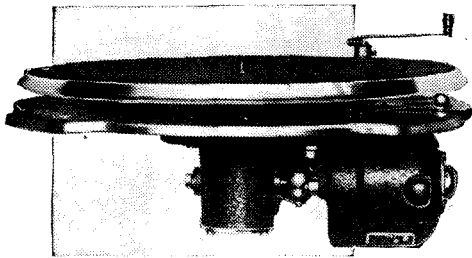

The Garrard Model U.5 has been evolved after many months of careful experiment and research. It embodies the highest standard of Garrard workmanship and material and operates with perfect regularity and control. It provides D.C. users with an ideal Radio-Gram Unit and enables them to enjoy the advantages of perfect radio reproduction. Its low cost combined with the ever-present possibility of D.C. being converted to A.C. current makes its possession a sound investment.

For full details write to:

GARRARD ENGINEERING & MANUFACTURING CO., LIMITED
 SWINDON, WILTS. 17, GRAFTON STREET, W.1
 Telephone: Swindon 534 & 535 (2 lines) Telephone: Regent 7596.

MORE SOUND DATA on EARL SPEAKERS

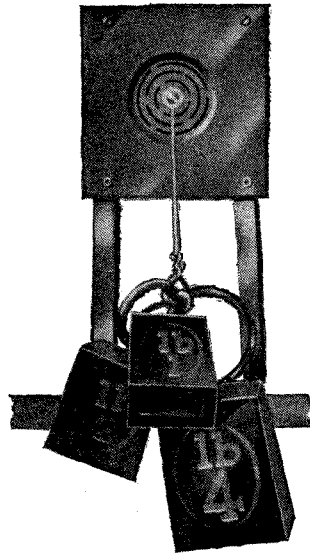

The arrangement shown at the left consists of an Earl centring device supported in a steel plate. To the centre of the device is attached a cord carrying weights totalling 7 lbs. Read the text and see what this means to you as a loud speaker user.

In addition to the electrical consideration of a loud speaker the mechanical aspects merit attention. One of the most important mechanical points of every moving coil loud speaker is the centring device or spider, as upon its correct functioning depends not only the acoustic properties of the speaker but also its freedom from mechanical breakdown.

The chief requirements of all centring devices are (1) Extreme lateral rigidity; (2) Free and equal axial movement either side of the position of rest; (3) Natural resonance outside the audible range; and (4) Mechanical strength.

The new Earl Spider (Reg. Design No. 791430) fully carries out all these requirements.

The illustration shows this spider carrying a weight of 7 lbs. without any signs of distress, eloquent testimony to its extreme lateral rigidity. Its actual bursting point could not accurately be ascertained owing to the difficulty of finding an adhesive strong enough to secure the spider to the metal plate used in the tests. Between 7 and 9 lbs. the adhesive gave way, the spider remaining undamaged. From the illustration can be seen how the ingenuity of the design has overcome resonance difficulties. The variations in the size of the small amount of unsupported material are such that all tendency to the building up of resonances is killed at once. Despite the lateral rigidity the freedom axially is such that it requires a weight of only 12.4 grammes to move the spider 1/64 in., in one direction, representing an overall movement of 1/32 in., an amplitude well in excess of that obtained under average room conditions. When it is realised that an input of 8 watts undistorted at 50 cycles represents a spider movement of 3/16 in. overall, i.e., 3/32 in. in one direction, and that this is obtained by a weight of only 3 ozs., some idea of the freedom of movement is obtained. A weight of 32 ozs. was required to permanently distort the spider representing a movement of .1284 in. in one direction, that is to say .2568 in. overall, or even 1/4 in., an amplitude far in excess of any likely to be required by other than a giant public address speaker.

By unremitting research and the allowance of extreme margins of safety the Earl Moving Coil Loud Speaker is capable not only of giving the highest quality but continuing to do so indefinitely, even under the most adverse conditions.

PRICES: PERMANENT MAGNET from 32/6
 ENERGISED from 25/-

EARL MANUFACTURING CO., LTD.,
 AVENUE WORKS, HANOVER PARK, S.E.15.
 'Phone: NEW X 0422

These

Regd. Trade Mark.

WEARITE COMPONENTS

are specified for the

AUDIO-FREQUENCY TEST OSCILLATOR

- Wearite Special Tapped Choke 8/20 henrys - - 15/-
- Wearite Special Tapped Choke 0.25/0.55/1.2 henrys 10/-
- Wearite Choke, type HT 25 - - - - - 9/-
- 2 Wearite 5-way Single pole switches - - 1/6 each

—and

WEARITE COILS for the "W.W." SINGLE SPAN RECEIVERS

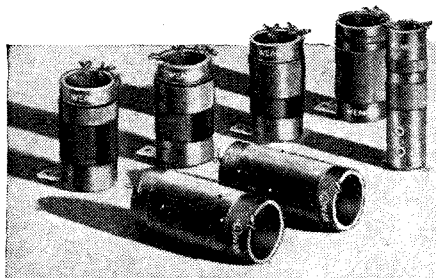

The set of Seven Coils complete with brackets and bushings for assembly in receiver. Each set guaranteed to "W.W." Specification. **12/6** PER SET

Approved "W.W." formers, all to original dimension, drilled, complete with brackets. **3/6** PER SET

Messrs. Wright & Weaire Ltd., 740, High Road, Tottenham, N.17.



Mention of "The Wireless World," when writing to advertisers, will ensure prompt attention.

MISCELLANEOUS ADVERTISEMENTS

NOTICES.

THE CHARGE FOR ADVERTISEMENTS in these columns is

12 words or less 3/- and 3d. for every additional word.

Each paragraph is charged separately and name and address must be counted.

SERIES DISCOUNTS are allowed to Trade Advertisers as follows on orders for consecutive insertions, provided a contract is placed in advance, and in the absence of fresh instructions the entire "copy" is repeated from the previous issue: 13 consecutive insertions 5%; 26 consecutive, 10%; 52 consecutive, 15%.

ADVERTISEMENTS for these columns are accepted up to **FIRST POST ON MONDAY MORNING** (previous to date of issue) at the Head Offices of "The Wireless World," Dorset House, Stamford Street, London, S.E.1, or on **SATURDAY MORNING** at the Branch Offices, 19, Hertford Street, Coventry; Guildhall Buildings, Navigation Street, Birmingham, 2; 260, Deansgate, Manchester, 3; 26a, Renfield Street, Glasgow, C.2.

Advertisements that arrive too late for a particular issue will automatically be inserted in the following issue unless accompanied by instructions to the contrary. All advertisements in this section must be strictly prepaid.

The proprietors retain the right to refuse or withdraw advertisements at their discretion.

Postal Orders and Cheques sent in payment for advertisements should be made **& Co. payable to ILIFFE & SONS Ltd., and crossed & Co. Notes being untraceable if lost in transit should not be sent as remittances.**

All letters relating to advertisements should quote the number which is printed at the end of each advertisement and the date of the issue in which it appeared.

The proprietors are not responsible for clerical or printers' errors, although every care is taken to avoid mistakes.

IMPORTANT NOTICE.

Owing to the August Bank Holiday, the issue of "THE WIRELESS WORLD" for August 10th must be closed for press earlier than usual.

MISCELLANEOUS ADVERTISEMENTS for insertion in that issue can be accepted up to

FIRST POST FRIDAY, August 3rd.

Set Manufacturers' Surplus, Clearance and Bankrupt Stocks offered in any of these columns may not be Manufacturers' current lines. Radio components advertised at below the list price do not carry any manufacturer's guarantee.

RECEIVERS AND AMPLIFIERS, ETC.

- L. EASTWOOD Sound System.**
REPRODUCTION that is Almost Perfect."
TYPE PP.12.2 Two Stage Push-pull Amplifier, with an undistorted output of 12 watts; this amplifier is very suitable for use in dance halls, theatres, etc., for band, repeater work or anywhere where a large output combined with quality is desired; can be supplied in single or double path formation complete on rack ready for installing.
SINGLE Amplifier, complete with B.V.A. valves, in steel case; price 18 guineas.
70, Pitfield St., N.I. Clerk. 7693. [6147]
19 35 Models 4 Valve Superhet. A.C. or D.C., M.C. Speaker, £3/19/6; 5 valve, £5 5s. including valves; approval.—Royal, 5, Buckingham Rd., London, E.18. [6126]
£4/10.—200-250 A.C. band-pass S.G.3, in attractive walnut case, similar to Lotus, complete with valves and Rola M.C. 3-gang Radiophone, screened coils, listed £10/10.
55/-—S.G.3 band-pass battery receiver, as above, with P.M. Rola or Sonochord (without valves, batteries), listed £8/8; similar set S.G.3, 2-gang Polar, Ormond loud-speaker, in identical cabinet, for 42/6; all c.o.d., carriage forward.—Kay, 167, City Rd., London, E.C.1. [6158]
OUR Kit of Parts for "Wireless World" Quality Amplifier, complete in every detail, including valves; amplifier only, £5/10; feeder unit, 35/-; send for detailed list of components.
WE Can Supply Kits for Any "Wireless World" receiver or amplifier; carriage paid, cash with order or c.o.d.
WARD, 45, Farringdon St., London, E.C.4. 'Phone: Holborn 9703. [6164]
SPECIAL Clearance.—New 1933-34 models Ultra Tiger 4v. Superhets, list 14 guineas, £8/15; also Alba, Ekco, Cromwell and G.E.C. sets; list on application.—R. B., 34, Ardern Terrace, Leicester. [6170]
COLUMBIA Portable Radio (306), S.G. suitcase, list 13 guineas, four only, demonstration models, slightly soiled, otherwise perfect; offered at 6 guineas each, carriage paid.—Rogers Radio, Lowestoft. [6176]

PILOT AUTHOR KITS

Exact to Specification

SINGLE SPAN RECEIVER and QUALITY AMPLIFIER

RECEIVER UNIT

Comprising Author's Kit of first specified parts for Receiver Portion only, including coils and condensers, ready mounted on Plymax Chassis Assembly, but excluding valves and cabinet. Cash or C.O.D. Carriage Paid. **£8 13 6**
 Or 12 monthly payments of 16/-.

AMPLIFIER UNIT

Comprising Author's Kit of first specified parts for Amplifier Portion only, including Ready-Drilled Chassis but excluding valves and Cabinet. Cash or C.O.D. Carriage Paid. **£10 10**
 Or 12 monthly payments of 19/3.

COMPLETE KIT

Comprising Receiver and Amplifier Kit, including complete set of 10 specified valves, but excluding Cabinet. **£27 8**
 Cash or C.O.D. Carriage Paid.
 Or £7 8 deposit and 11 monthly payments of 40/-.

BATTERY SINGLE SPAN
RECEIVER KIT 26 12 6
OUTPUT KIT 21 13 9
COMPLETE KIT including set of specified valves, but less cabinet £12 16 0
UNIVERSAL SINGLE SPAN
KIT "A" £10 2 6
KIT "B" including set of specified valves, less cabinet. £15 17 6
PETO-SCOTT PLYMAX CHASSIS (As specified, Ready-Drilled)

SINGLE SPAN RECEIVER and QUALITY AMPLIFIER
 For Receiver Chassis Cash or C.O.D. 8/6 Postage 9d.
 For Amplifier Unit (Metal) Cash or C.O.D. 12/6 Postage 9d.
 *Orders for both Chassis, Cash or C.O.D., 2/- Post Free.
BATTERY SINGLE SPAN
 For Receiver Unit Cash or C.O.D. 8/6
 For Output Unit Cash or C.O.D. 4/-
UNIVERSAL SINGLE SPAN Cash or C.O.D. 9/9
PETO-SCOTT CO. LTD.
 77 CITY RD., LONDON, E.C.1 'Phone: Clerkenwell 9406/7
 West End Showrooms: 62, High Holborn, London, W.G.1
 Est. 1919.

AMERICAN TYPE VALVES

Philco Valves—all with a definite guarantee—are suitable for all American makes of radio sets.
Philco Type 80—Full Wave rectifier 350 volts, 125 ma
 —Price 8/- 6A7, 2A7 and 1A6 Heptodes at 16/-
 ● Write for Full Price List or for price of special type required giving the maker's type number.
PHILCO
 ● The Philco Radio and Television Corporation of Gt. Britain Ltd., Valve Dept., Perivale, Middlesex. 'Phone: Perivale 3344

Specified by the Experts
SOUND SALES
TYPE PP/QA MAINS TRANSFORMER 60/-
 Specified for the "W.W." Quality Amplifier
TRANSFORMERS. CONVERSION UNITS. CHOKES.
 Sound Sales Ltd., Tremlett Grove, Highgate, N.19

ELECTRADIX FREQUENCY RECORDS

For Testing, Speaker, Set and Microphone. These Gramo. Records are all cut to constant amplitudes and the harmonic content is less than 5 per cent.
Disc 89, 1000 cycles per sec. two-minute band; for general test.
Disc 90, 5000 and 6000 cycles per sec. one minute of each.
Disc 87, Short bands of 20, 30, 40, 50, 60, 70 cycles per sec.
Disc 96, Short bands of 80, 90, 100, 125, 150, 175.
Disc 95, Short bands of 200, 250, 300, 350, 400, 450.
Disc 94, Short bands of 500, 600, 700, 800, 900, 1000.
Disc 93, Short bands of 1250, 1500, 1750, 2000, 2250, 2500.
Disc 92, Short bands of 2750, 3000, 3250, 3500, 3750, 4000.
Disc 91, Short bands of 4250, 4500, 4750, 5000, 5250, 5500.
Disc 90, Short bands of 5750, 6000, 6250, 6500, 6750, 7000.
 A new needle should be used for every test.
PRICE Per Record **2/6** Set of Ten **£1**
ELECTRADIX RADIOS
 218 Upper Thames Street, London, E.C.4
 Telephone: Central 4611.

NUMBERED ADDRESSES.

For the convenience of private advertisers, letters may be addressed to numbers at "The Wireless World" Office. When this is desired, the sum of 6d. to defray the cost of registration and to cover postage on replies must be added to the advertisement charge, which must include the words Box 000, c/o "The Wireless World." All replies should be addressed to the Box number shown in the advertisement, c/o "The Wireless World," Dorset House, Stamford Street, London, S.E.1. Readers who reply to Box No. advertisements are warned against sending remittance through the post except in registered envelopes; in all such cases the use of the Deposit System is recommended, and the envelope should be clearly marked "Deposit Department."

DEPOSIT SYSTEM.

Readers who hesitate to send money to advertisers in these columns may deal in perfect safety by availing themselves of our Deposit System. If the money be deposited with "The Wireless World," both parties are advised of its receipt.

The time allowed for decision is three days, counting from receipt of goods, after which period, if buyer decides not to retain goods, they must be returned to sender. If a sale is effected, buyer instructs us to remit amount to seller, but if not, seller instructs us to return amount to depositor. Carriage is paid by the buyer, but in the event of no sale, and subject to there being no different arrangement between buyer and seller, each pays carriage one way. The seller takes the risk of loss or damage in transit, for which we take no responsibility. For all transactions up to £10, a deposit fee of 1/- is charged; on transactions over £10 and under £50, the fee is 2/6; over £50, 5/-. All deposit matters are dealt with at Dorset House, Stamford Street, London, S.E.1, and cheques and money orders should be made payable to Iliffe & Sons Limited.

SPECIAL NOTE.—Readers who reply to advertisements and receive no answer to their enquiries are requested to regard the silence as an indication that the goods advertised have already been disposed of. Advertisers often receive so many enquiries that it is quite impossible to reply to each one by post. When sending remittances direct to an advertiser, stamp for return should also be included for use in the event of the application proving unsuccessful.

Receivers and Amplifiers, Etc.—Contd.

- H.M.V.** 120 Watts A.C. Amplifier, 110-240 volts, 2 D.A. 60 valves in output stage, suitable for gram., radio, or mic. work, current for microphone incorporated; less valves, £12 10.
G.E.C. 60 Watts P.A. Amplifiers in Tak Cases, last few to clear, £2/10 each.
MARCONI 60 Watt "Rack" Amplifier, converter driven, D.A. 60 in output stage; less valves, £6/10.
LARGE and Varied Stock of P.A. Amplifiers, microphones, speakers, converters, heavy duty chokes, transformers, meters, condensers, etc.; stamp for lists and prices, callers invited.
H. FRANKS, 23, Percy St., Tottenham Court Rd., W.1. Museum 8585. [6162]
3-STAGE Amplifier, D.A. 60 output, 250 A.C. twin turntables, Bayliss mains equipment, 2 Baker super cinema speakers, 105v. fields, also 105v. converter; complete, £70, or nearest offer; separately if desired.
ALSO One Rola Model "R" 110v. Speaker, £3; one 220v., with rectifier, £5; second-hand.—Electrical Service Company, Lichfield St., Walsall. [6177]
PYE G.B. Q.P.P. £7; Burgoyne transportable 3, £3; Osram 33, factory built, £4/10; Norman 6v. A.C. D.C., 10-2,000 m., £10; all battery sets include valves, batteries, speaker.—Warren, 38, Inglis Rd., Ealing Common, W.5. [6180]
FERRANTI "Arcadia" Console, brand new, unused; list 23 guineas, 14 guineas; before purchasing elsewhere, send for details of special offers; easy terms if desired; bankrupt stock.—151, Wellingborough Rd., Northampton. [6178]
MARCONIPHONE 276 7-valve A.C. Superhet, used one month, £12, cost £17/10; H.M.V. A.C. automatic record changer playing desk, £5; both as new; General Electric converter, 240 D.C. input, 240 volt 90 watt A.C. output, £4/10.—Newbury's Radio, 46, Mayes Rd., Wood Green, N.22. [6172]
ARMSTRONG Latest Radio-Gram Chassis, incorporating advanced designs, Superheterodyne including Marconi valves, Royalties paid, £6/18/6; Armstrong 4 valve, 3 pentode chassis, complete, £5/18/6; Universal 4 valve chassis, complete, £5/18/6.—Armstrong Company, 100, King's Road, N.W.1. [6138]
PUBLIC Address Amplifiers.—A.C. mains, three stage, 21 watts, undistorted A.C. output, complete with valves, £15; universal A.C./D.C. three stage, 7 watts output, complete, £13; guaranteed 12 months; trade supplied; deferred terms.—D. E. Clarkson, B.Sc. (Eng.), 45, Manor Rd., Wallington, Surrey. 'Phone: Wallington 3953. [6120]
GEOPHONE 5-valve Supersonic Heterodyne, including valves, coils, 15 to 720 metres, connecting cords, etc., excellent condition, hardly used; also Marconiphone model 255 6-valve portable superheterodyne, excellent condition, complete; above for sale separately or together; first reasonable offer accepted.—Richard Nash, Rucklenford Lodge, Queen's Rd., Weybridge. [6103]
MIDGET Receiver, brand new, ideal for travellers, etc., working off A.C. and D.C. mains, 100-130 or 200-240 volts, by universal adapter supplied, all incorporate M.C. speaker, provision for gramophone pickup, L. and M. wave, complete with valves, etc.; Emerson 5-valve chassis (as above), sealed cartons, £3 15; above chassis, incorporated in handsome figured walnut cabinet (10x7x5 1/2), list 10 guineas, at £4 6/3; also (six only) Spartan "63" 6-valve, 7-stage, superhets, 3-point tone control, A.V.C., walnut cabinet (12 1/2 x 7 1/2 x 4 1/2), guaranteed over 70 stations, at £7/10; carriage paid; cash with order or c.o.d.—Degalliers, 4-21, Upper Marylebone St, London, W.1. [6163]

MAINS EQUIPMENT.

VORTEXION Leads Again.
VORTEXION Specified Single Span Model, 350-100 m.a., 4v. 5a. C.T., 4v. 2.5a. C.T., 4v. 1a. C.T.; 25/-, less terminals, 23/-, less 5-year guarantee 21/-; power chassis, complete, £3/10; steel chassis only, 7/6; also normal model, shrouded, at 16/-, special shrouded choke 12/6.
VORTEXION—Quality amplifier or super monodial, 425-0-425, 120 m.a., 4v. 6-8a. C.T., 4v. 3a. C.T., 4v. 1a., 4v. 1a., super shrouded, core size 2 1/2 in. x 1 1/2 in., 2 1/2% regulation primary engraved insulated terminals, weight 14lb., 25/-, carriage 2/-; normal shrouded, 22/-; open type, 20/-, post 1/3; speaker field replacement choke, 16/-; special output transformer, to "W.W." spec., 12/6.
VORTEXION 7-30h. 120 m.a. Choke, 215 ohms, in die cast shrouding to match; 12/6.
IMITATED, but unequalled. Good enough for a "Wireless World" specification is good enough for you.
VORTEXION Cost Little More than the Cheapest, but unequalled by the dearest.
VORTEXION Standards Despatched by Return.
VORTEXION A.C./34 used by author in construction of A.V.C. Three, as illustrated; 18/-.
GUARANTEED 12 Months, and within 5% normal and 2 1/2% super models, neat shrouding, with detachable feet, as used by Government Departments, etc.; any model guaranteed 5 years at extra cost of 2/-.
ALL Secondaries Centre Tapped
VORTEXION—250-0-250 60 m.a. 4v. 1 to 2a., 4v. 2 to 4a., open type, 10/-; shrouded, 12/6; post 9d.
VORTEXION—Ferrocart III, 350-0-350, 60 m.a., 4v. 2.5 C.T., 4v. 3.5 C.T.; open type 15/6, shrouded 16/-; post 9d.
VORTEXION—Super model for H.T.8 or 9 or 10, 4v. 1 to 2, 4v. 2 to 4; open type 14/6; shrouded 16/6; post 1/-.
VORTEXION—350-0-350, 120 m.a., 4v. 2 to 5a., 4v. 2 to 4a., 4v. 2.5a.; open type, 14/6; shrouded, 16/6; super shrouded model, weight 11lb., 4 filaments to specification, 21/-; post 1/3.
VORTEXION—400 or 450 or 500v. 120 m.a., 4v. 2 to 5, 4v. 2 to 5, 4v. 2, 5a.; open type, 19/-; shrouded, 23/-.
VORTEXION—400 or 450 or 500, 150 m.a., 4v. 4a., 4v. 2.5, 4v. 2, 4v. 2, 4v. 2, core size 2 1/4 x 1 1/4 in., a super job, 2% regulation, 35/-; shrouded, with terminals; less terminals, 30/-; open type, 26/-; post 1/3.
VORTEXION Auto Transformers to B.E.S.A. Specification, 100, 110, or 120v. to 200, 220, or 240 volts, 60 watts, 9/-; post 9d.; 120 watts, shrouded 12/6, open type 10/6, post 1/3; 200 watts, shrouded 16/6, post 1/-; 2,000 watts, £4/10.
VORTEXION 1,000-watt Transformers; £4/10, carriage free.
VORTEXION 30h. at 60 m.a. Chokes, 5/6; 40h. at 60 m.a., 8/6; 30h. at 150 m.a., 200 ohms, 10/6 open type, 12/6 shrouded.
VORTEXION Transformers Made to Your Specification; price according to wattage, 6v. filaments same price unless wattage grossly exceeded; special quotations by return.
VORTEXION (S. A. BROWN), 182, The Broadway, Wimbledon, S.W.19. Tel: Liberty 2814. [5901]
TANTALUM for A.C. Chargers H.T. and L.T., special offer, 1,000 Tantalum strips, 5/2 in. x 1/16 in. suitable for trickle chargers, 1/3 each. Blackwell's Metallurgical Works, Ltd., Garston, Liverpool. [5039]
HOYNE'S Transformers, fitted with tapped and screened primaries, filaments, all centre tapped, stout cast aluminium clamps and clearly marked terminal strips are fitted to all models; write for list.
HOYNE'S components are Guaranteed for One Year; **HOYNE'S** one type only manufactured, the best, as used by many well-known set manufacturers after testing all others.
HOYNE'S—"W.W." transformers, tested strictly to specification of author; "W.W." test reports, June 22nd: "The insulation is particularly good throughout the transformer is satisfactory in all respects."
HOYNE'S—Push-pull quality amplifier transformer, 25/-, post 1/3; 7/30 henrys choke, 9/6, post 9d.; 20 henrys, 7/6, post 9d.
HOYNE'S—Single span, 15/-, post 1/-; choke, 10 henrys, 7/6, post 9d.
HOYNE'S—Everyman A.C. super transformer, 12/6, post 1/-; choke 10 henrys, 7/6, post 9d.
HOYNE'S—A.V.C. Straight Four transformer, 18/-, post 1/3; choke, 26 henrys 120 m.a., 140 ohms, 9/6, post 9d.
HOYNE'S—A.V.C. Three transformer, 12/6, post 1/-; choke 30 henrys, 60 m.a., 7/6, post 9d.
HOYNE'S—250-0-250v. 60 m.a., 4v. 1 to 2a., 4v. 2 to 4a., 10/-, post 9d.; with extra 4v. 1 to 2a. winding, 13/6, post 1/-.
HOYNE'S—Ferrocart III, 350-0-350v. 60-70 m.a., 4v. 2 to 3a., 4v. 2 to 4a., 12/6, post 1/-; with extra 4v. 1 to 2a. winding, 13/6, post 1/-.
HOYNE'S—500-450-0-450-500v. 140 m.a., 4v. 2 to 4a., 4v. 4 to 6a., 4v. 2a., 4v. 2a., 27/6, post 1/3; weight 11lb.
HOYNE'S Transformers, built to specifications up to 1 K.V.A., keenest prices, best materials and workmanship; quotation by return.
M. J. HOYNE, ALL-POWER TRANSFORMER, Ltd., Offices and Works, 8a. Gladstone Rd., Wimbledon, S.W.19. Tel: Liberty 3303. [6079]
PARAMOUNT Mains Transformers are Equal to Any, yet unequalled in price; guaranteed for 12 months, and manufactured from the finest British materials; they are fitted with smart aluminium shrouds and frames, all filaments centre-tapped; finest quality insulating paper between each layer, and thoroughly tested before leaving our works.
PARAMOUNT 500-0-500v. or 450, or 400, 120 m.a., 4v. 5a., 4v. 4a., 4v. 2.5a., shrouded, screened primary, 21/-; open, 18/- post 1/3.
PARAMOUNT Single Span 350-0-350v. 100 m.a., 4v. 5a., 4v. 2.5a., 4v. 1a., shrouded, screened primary, super regulation, 18/6, post 1/-.
PARAMOUNT 350-0-350v. 120 m.a., 4v. 2.5a., 4v. 2-4a., 4v. 2.5a., shrouded, screened primary, 16/-, post 1/-.
PARAMOUNT 250-0-250v. 60 m.a., 4v. 1-2a., 4v. 2-4a., 10/-; shrouded, 12/-, post 9d.
PARAMOUNT Chokes 30h. 60 m.a., 5/-, post 9d.; 20h. 120 m.a., 9/-.
PARAMOUNT Auto-transformers 100-120/200-250v. or vice versa, 60 watt 8/-, 120 watt 10/-, shrouded 12/-, post 9d.
(This advertisement continued in third column.)

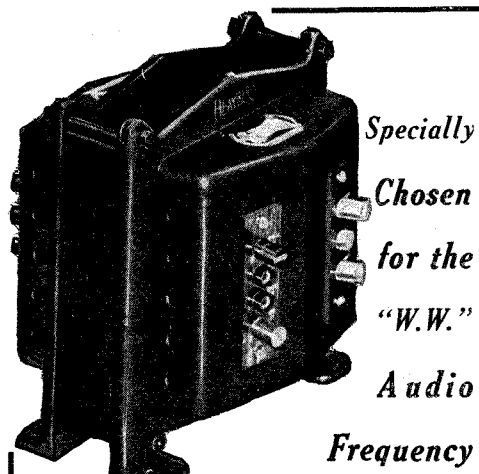

Specially
 Chosen
 for the
 "W.W."
 Audio
 Frequency

TEST OSCILLATOR

Type W.29 Transformer is characteristic of the highest standard manufactured by Heayberd—the undoubted leaders of Mains Radio. Heayberd Mains Transformers have been specified during the past season by discerning Set designers more times than any other make.

Model W.29 . . . Price 22/6
 Immediate delivery of any quantity from stock.

Send 3d. stamps for 40-page handbook showing numerous circuits of how to build your own amplifier, charger, mains unit, etc.



10, Finsbury Street, LONDON, E.C.2.
 One Minute from Moorgate Station.

ALL MECHANICS WILL HAVE FLUXITE
IT SIMPLIFIES ALL SOLDERING

All Ironmongers sell Fluxite in tins: 4d., 8d., 1s. 4d., and 2s. 8d. Ask to see the **FLUXITE POCKET SOLDERING SET**—complete with full instructions—7s. 6d. Ask also for our leaflet on **HARDENING STEEL** with Fluxite.

FLUXITE LTD. (Dept. W.W.),
Dragon Works, Bermondsey Street, S.E.1

FOR ALL REPAIRS!

Mains Equipment.—Contd.

(This advertisement continued from first column.)
PARAMOUNT Guaranteed Electrolytic Condensers, 4-0-4 mid., 500v. peak, 3/6, post 3d.
PARAMOUNT for H.T.8, 9, or 10 4v. 1-2a., 4v. 2-4a., 15/6, shrouded, post 1/-.
PARAMOUNT—Write for details of our super induction 5-valve receiver, with Rola moving coil speaker, Colvern Ferrocart coils, Polar condensers, and variable Mu valves; price £9; there is no greater value on the market, irrespective of price.
PARAMOUNT Mains Transformers, manufactured by Brock & Salter, 66, Hartfield Rd., Wimbledon, S.W.19 (one minute from Wimbledon Station). Tel: Liberty 3226. [5998]

CABINETS.

MANUFACTURERS' Clearance.
ULTRA "Panther," a modern cabinet, with contrasting figured walnut veneer panels, 20x17x11, 13/6; pedestal type, 35x22x12, 30/-, undrilled; photo sent on request.
SET and Speaker Cabinets; 5/- upwards.
RADIOGRAM Cabinets; 37/6 upwards
SPEAKER Cabinets; 4/6 upwards.

SEND Particulars of Your Requirements (giving size of set, etc.), or call and make your choice from our stocks of over 100 different types; from 3/6 to £4/10.
REFER to Previous Advt. for Detailed List of Bargains.
H. L. SMITH and Co., Ltd., 287-9, Edgware Rd., London, W.2. Tel: Padd. 5891. [6052]

GRAMOPHONES, PICK-UPS, RECORDERS.
H.M.V. Auto Playing Desk, perfect order; £6/10; seen appointment.—Phone: Padd. 1384 10-8. [6150]

LOUD-SPEAKERS.

27/6!!!—Brand new B.T.H.-R.K. speakers, 6v. field, suitable for P.A. work, etc.
£2/7/6!!!—B.T.H. speakers, as above, for 100-250v. A.C., complete with field rectifier.
MAGNAVOX D.C.152 (9in. cone), 22/6; Magnavox 154 (6 1/2 in. cone), 16/3; all with hum-bucking coils, power or pentode transformers and 2,500 or 6,500-ohm fields; Magnavox P.M.254, 48/-.
ATTENTION to All Orders Within 24 Hours; carriage paid; cash with order or c.o.d.
WARD, 2nd Floor, 45, Farringdon St., London, E.C.4. Telephone: Holborn 9703.

12/6—Eight only, brand new permanent magnet moving coil speakers; cash with order.—I. Tavenor, 34, Mulgrave St., Liverpool [6149]

Vauxhall—Magnavox permanent magnets, universal, suitable for Class "B," power or pentode, 6in. cone 15/6; 7in. cone 17/6; 10in. cone 23/-; mains energised 2,500 or 6,500, 10in. cone 23/-; 7in. cone 15/3; brand new, with humbucking coils; state power or pentode transformer; unused manufacturers' stock; immediate delivery, carriage paid, cash with order or c.o.d.—Vauxhall Utilities, 163a, Strand, W.C.2. Temple Bar 9358. [6136]

DEGALLIERS Offer Set Manufacturers' 1934 boxed Surplus, positively last lot until October, all carriage paid, cash with order or c.o.d. Moving coil speakers: Utah Midgets, 2,500, at 14/6 (U.S.A.); Rolas F.6 (7 1/2 in. diameter), 2,500 ohms (110-175v. D.C.), 6,500 ohms (200-250v. D.C.), list 35/-, at 18/-; F.7 (9in.), voltages as in F.6, list 47/6, at 25/-; permanent magnets, F.6P.M., 7 1/2 in. diameter, list 49/6, at 28/-; F.7P.M. (9in.), list £5, at 33/-; energised speakers, incorporate humbuckers, state if for power or pentode.—Degalliers, 4/21, Upper Marylebone St., London, W.1. [6130]

VALVES.

ALL Types of Brand New American Valves in Stock; first-class makes, guaranteed.
247, 41, 38, 39, 78, 75, 57, 58, 224, 44, 36, 255, 83, 43, 12/-; 2525, 4/6; U.X.171A, U.X.199, U.X.280, U.X.245, U.X.226, U.Y.227, 7/6; U.X.250, U.X.210, U.Z.281, 17/6; U.X.867 photocells, 25/-; various transmitting valves in stock; post paid; cash with order or c.o.d.
WARD, 2nd Floor, 45, Farringdon St., London, E.C.4. Phone: Holborn 9703. [5722]

METROPOLITAN RADIO SERVICE Co. for Guaranteed American Valves; any type at keenest prices; terms to trade.—1021, Finchley Rd., Golders Green, N.W.11. Speedwell 3000. [0436]

FREE—List of American and non-ring valves.—Epton, 95, New Rd., Chingford, E.4. [6086]

SURPLUS Valves.—All brand new; battery types, 2-volt, H.F.2, L.F.2, L.P.2, 1/9; super power, P.P.2, 2/6; screens and pentodes, 3/9; A.C. mains, 4-volt 1 amp., general purpose, 3/3; power, 4/-; screens and pentodes, 4/6; full wave rectifiers, 3/6; postage paid, cash with order, or c.o.d. over 10/—Clarion Radio Valve Co., 855, Tyburn Rd., Erdington, Birmingham. [6155]

PREMIER SUPPLY STORES announce the Purchase of the Complete Stock of a World Famous Continental valve manufacturer; all the following standard main types fully guaranteed, 4/6 each; H., H.L., L. power, medium, high, low mag., and variable mu screen grids, one, three and four Watt A.C. output, directly heated pentodes, 250v. 60 m.a. full wave rectifiers, d.c. types, 20v. 18 amp., filaments, screen grid H., H.L. power.

THE Following Types, 5/6 each; 350v. 120 m.a., full wave rectifier, 500v. 120 m.a. full wave rectifier, 2 1/2 Watt indirectly heated pentode.

THE Following American Types, 4/6; 250, 112, 171, 210, 245, 226, 47, 46, 24, 35, 51, 57, 58, 55.

PREMIER SUPPLY STORES, 20 and 22, High St., Clapham, S.W.4. [6011]

COMPONENTS, ETC., FOR SALE.

1/6—Cadmium plated chassis, 4-valve, pressed steel, 14x9; pos. 6d.
2/9—Plew A.V.C. units for battery receivers, prevents fading, list 10/-, brand new.—Kay, 167, City Rd., London, E.C.1. [6159]

Components, Etc., for Sale.—Contd.

R. RYALL'S RADIO, 33, Chancery Lane, London, W.C.2 (nearest Tube, Chancery Lane; bus 67 passes door, or tram to Savoy St., Holborn 3529. Open Saturday afternoon. Close 7 p.m., Saturday 5 p.m., Thursday closed 1 o'clock)

SET Repairs, any commercial or amateur built set serviced, at trade prices, British or American, satisfaction guaranteed.

SINGLE Span Set, complete with Celestion speaker and power pack, less valves; £6/15.

RADIOPHONE Radiopaks, B.P. and H.F., 30/-; R.F. superhet 117.5 K.C., 50/-; 110 K.C. ditto; B.P. superhet, 110 K.C., 50/-; all postage 1/3; Varley P.P. input transformer, new, 10/6; Clydon dual thumb drive, 0.005, new, 7/6.

PAIR R.I. Class B Transformer and Choke, second-hand, 14/-; Lewcos frame aerial, 7/6; Rich and Bundy chokes, E154 25H, at 50 m.a., 90 ohms, 12/6.

GARRARD D/S Gramophone Motor, complete with unit plate, perfect, plays 3 12in. records, cost £3, 25/-; Varley EP24 transformer, 500/500v., 3-4v. 5 amp. windings, new, 31/6.

FERRANTI Transformers, A.F.4, 7/6; A.F.3, 10/6; A.F.5, 18/6; A.F.7, 18/6; A.F.5c, 20/-; A.F.5s, 22/6; O.P.M.1, 10/-; O.P.M.1c, 15/6; B1 choke, 10/6; O.P.M.16c, 15/6; A.F.11c, 15/-; O.P.M.11c, 16/6; A.F.7c, 21/6.

SIFAM 0-6v. Meter, 10/-; Weston 301 0-100 m.a., 20/-; Turner 0-100 m.a., with cut-out switch, 17/6; Weston 0-300 m.a., projecting, 20/-; Ferranti, 0-10 amps., 15/-; Weston 301, centre zero, bakelite cased, 20/-; 0-100 m.a.; Sifam 0-300 m.a. 15/-; all otherwise moving coil and flush type.

R. [6157]

24. MILDMAY RADIO EXCHANGE Offers the Following, sound and perfect; cash with order or c.o.d.

METERS.—Pifco De Luxe radiometer, 42/- model, 22/6; Ferranti triple range m.-amp. 0.7, 0-15, 0.30, 25/-; 0-2 m.-amps., flush, 22/6; 0-1 amp., 12/6; 0-20 amps., 12/-, 15/-; 15 amps., 12/-; Weston, type 301, 0.3 m.-amps., 20/-; type 506, 0-150 volts, 12/-; 0-250 volts, A.C. type 517, 20/-; type 506, 0-150 m.-amps., 14/-.

FERRANTI Transformers.—A.F.4, 8/-; A.F.3, 12/-; A.F.5, 17/6; A.F.6, 18/-; A.F.5c, 19/-; outputs, O.P.1, 1-1, 7/6; O.P.2, 25-1, 7/6; O.P.3c, 10/-; O.P.4c, 10/-; O.P.M.16c, 14/-; O.P.M.4c, 14/-; O.P.M.15c, 14/-; A.F. 7, 18/6.

FOSTER Mains Transformer, 700-0-700 120 m.-amps., 4v. 3a., 4v. 2a., 4v. 1a., 200-250 input, 25/-; Parmeko 425-0-425 60 m.-amps., 4v. 2 amps., 4v. 3 amps., 200-250 input, 25/-; Parmeko, 200-0-200 60 m.-amps., 4v. 3a., 4v. 1a., 200-250 input, 18/-; Heayberd heavy duty I.F. choke, type 755, 15/-; Heayberd filament transformer, 4 volt 10 amps., 7/6.

WEARITE "Wireless World" Everyman, 4 coils, 16/-; Polar Star Minor 3-gang, 10/6; Radiophone 3-gang condensers, 7/6 each; pair Ferracort Colverdynes, 15/6.

RADIOPHONE Band Pass Superhet, Radiopaxes, 30/- each; RF superhet type, 32/6; Westinghouse H.T.7, 8/-; transformer for same, R.I., 7/-; H.T.5, 6/-.

MAGNAVOX Dual Matched Type "Magna," series 144 and 142, 2,500 ohms, £3 pair; Magnavox, type 152, 10in. 200 ohms field, 27/6; B.T.H. Senior R.K. P.M. moving coil speaker, 45/-; 1934 Baker's super type P.M., 50/-; Epoch type A.2, 17/6.

SPECIAL Clearance Offer:—

TEISEN Super Selective Six Receiver, complete, as specified, but less valves; £2/10.

WIRELESS World "All-wave Receiver, 7-valve, complete with all specified parts, including the "Eddy-stone" short wave coils, less valves; £3.

8-VALVE Battery Operated Chassis, 4-screen grid with push-pull output, less valves; £2/10.

1934 Portadyne 4-valve Battery Operated Receiver, 2-screen grid with pentode output, fitted with moving coil speaker in latest type oblong walnut cabinet, with full vision dial with valve and stand, boxed; £5.

FERRANTI Inductor Dynamic Loud Speaker, equal and, in fact, better than cheap moving coils; 20/-.

EKCO Mains Units.

TYPE A.C.25, output 150 volts 25 m.-amps., having 4 tappings, 2 variable; listed at £3/17/6, our net price 33/6.

TYPE K.25, output 150 volts 25 m.-amps., having 4 tappings, 2 variable, also trickle charger for 2, 4- or 6-volt accumulator; listed at £5/7/6, our price 39/-.

TYPE K.12, output 150 volts 12 m.-amps., with charger for 2, 4- or 6-volt accumulator; 35/- each, all brand new in sealed boxes.

THE Above Post or Carriage Paid.

THONE: Clissold 5001.

OPEN All Day Thursday, closed all day Saturday.

24, Mildmay Grove, London, N.1. [6156]

PREMIER.

PREMIER SUPPLY STORES Offer the Following Set Manufacturers' Surplus New Goods at a Fraction of the Original Cost; all goods guaranteed perfect, carriage paid over 5/-, under 5/- carriage forward, I.F.S. and abroad, carriage extra.

SPECIAL Offer of P.M. and Energised M.C. Speakers, from well-known gramophone manufacturer.

TYPE 10971G, 9in. diameter, 115 ohm field, 120-200 m.a., with power output transformer, handle 4 watts; 17/6.

TYPE 10971C, 9in. diameter, 2,000 ohm field, 40-70 m.a., Pentode transformer, handles 4 watts; 17/6.

TYPE 10955F, 9in. diameter, 11,650 ohm field, 20-30 m.a., auditorium type power transformer, handles 10 watts; 30/-.

TYPE 10955H, 9in. diameter, 115 ohm field, 350-400 m.a., auditorium type Pentode transformer, handles 10 watts; 30/-.

TYPE 4480B, 9in. diameter, permanent magnet, handles 4 watts, 7 ohms speech coil, 13/6; Multi ratio transformer, 4/6 extra.

ELIMINATOR Kits, including transformer, choke, Westinghouse metal rectifier, T.C.C. condensers, resistances, and diagram, 120v., 20 m.a., 20/-; trickle charger, 8/- extra; 150v. 30 milliamperes, with 4v. 2-4 amps. C.T. L.T., 25/-; trickle charger 6/6 extra; 250v., 60 milliamperes with 4v., 3-5 amps C.T. L.T., 30/-; 300v. 60 m.a. with 4v., 3-5 amps, 37/6; 200v. 100 m.a., 39/6.

(This advertisement continued in third column.)

On Stand 119 at Radiolympia

HARTLEY TURNER

will offer you the complete realistic reproduction.

Radio-Gramophones, Electric Gramophones, Kit Sets & Loud speakers

Not a few "stunt" components and units, but the whole reproducing chain designed throughout by Hartley and Turner with only one object, "FREEDOM FROM DISTORTION."

New illustrated literature will be available and demonstrations will be held concurrently in various parts of London.

HARTLEY TURNER RADIO LTD.,

Thornbury Rd., Isleworth, Mdx.

Telephone: HOUUnslow 1854.

HARTLEY - TURNER SPEAKERS AND AMPLIFIERS SUPPLIED ON EASY TERMS.

We specialise in the supply of this superb equipment on convenient terms. Please write for full particulars and quotation.

All other high-grade radio Apparatus supplied on the best terms.

The LONDON RADIO SUPPLY COMPANY

11 OAT LANE, NOBLE STREET, LONDON, E.C.2.

Phone: National 1977. (Est. 1925).

CRANLEY SINGLE-SPAN COILS

52/6 per set of Seven.

Wired and Assembled Complete with Condensers, and Cans as specified, and Micro Dial. Coils only, per set of 7, 12/6. W.W. Single-Span Transformer, 35/-, 10 hr. Choke, 12/6. W.W. Q.A. Amplifier Transformer, 57/6. W.W. Multi Ratio Output Transformer, 50/-.

TRADE SUPPLIED.

CRANLEY RADIO LTD., 32, Craven Park Road, Harlesden, N.W.10 Phone: Willesden 3473.



The weekly journal for all who keep Canaries, British Hybrids or Foreign Pet Birds.

EVERY FRIDAY 2d. W.W.98

Specimen copy of recent issue free on request from The Publisher (W.W.), Dorset House, Stamford St., London, S.E.1.

Components, Etc., for Sale.—Contd.

(This advertisement continued from first column.)

PREMIER Chokes, 40 milliamperes, 25 hys., 4/-; 65 milliamperes, 30 hys., 5/6; 150 milliamperes, 30 hys., 10/6; 60 milliamperes, 80 hys., 2,500 ohms, 5/6; 25 milliamperes, 20 hys., 2/9.

ALL Premier Guaranteed Mains Transformers have Engraved Terminal Strips, with terminal connections, input 200-250v., 40-100 cycles, all windings paper interleaved.

PREMIER H.T.7 Transformer, output 135v. 80 m.a. for voltage doubling, 8/6; 4v. 3-4a., C.T. L.T., 2/- extra; with Westinghouse rectifier giving 200v. 30 m.a., 17/6.

PREMIER H.T.8 and 9 Transformers, 250v., 60 m.a., and 500v. 60 m.a. rectified, with 4v. 3-5a. and 4v. 1-2a. C.T. L.T. and screened primary, 10/-; with Westinghouse rectifier, 18/6.

PREMIER H.T.10 Transformer, 200v. 100 m.a., rectified, with 4v. 3-5a., and 4v. 1-2a. C.T. L.T. and screened primary, 10/-; with Westinghouse rectifier, 19/6.

PREMIER Mains Transformers, output 250-0-250v. 60 m.a., 4v. 3-5a., 4v. 2-3a., 4v. 1-2a. (all C.T.), with screened primary; 10/-.

PREMIER Mains Transformers, output 350-0-350v. 90 m.a., 4v. 3-5a., 4v. 2-3a., 4v. 1-2a. (all C.T.), with screened primary; 10/-.

PREMIER Auto Transformers, 100-110/200-250v. or vice versa, 100-watt; 10/-.

SPECIAL Offer of Mains Transformers, manufactured by Phillips, input 190-120v. or 200-250v., output 180-0-180 volts 40 m.a., 4v. 1 amp., 4v. 3 amps., 4/6; 200-0-200v., 4v. 1a., 4v. 3a., 4/6.

WESTERN ELECTRIC Mains Transformers, 300-0-300v. 65 m.a., 4v. 1-2a., 4v. 2-3a., 8/6; 500-0-500v. 150 m.a., 4v. 3-5a., 4v. 2-3a., 4v. 2-3a., 4v. 1a., C.T., 4v. 1a. C.T., 19/6; 1,000-0-1,000v. 250 m.a., 4v. 3a. C.T., 4v. 3a. C.T., 49/6, 2,000-0-2,000 150 milliamperes, 49/6.

PREMIER L.T. Charger Kits, consisting of Premier transformer and Westinghouse rectifier, input 200-250v. A.C., output 8v. 1/2 amp., 14/6; 8v. 1 amp., 17/6; 15v. 1 amp., 19/-; 6v. 2 amp., 27/6; 30v. 1 amp., 37/6, 2v. 1/2 amp., 11/-.

COLLARO Gramo. Unit, consisting of A.C. motor, 200-250v. high quality pick-up and volume control, 49/-; without volume control, 46/-.

BT.H. Trusped Induction Type (A.C. only) Electric Gramophone Motors, 100-250v., 30/- complete.

BT.H. Gramophone Motors, 100-250 volts A.C. or D.C., specially recommended for D.C., complete; 30/-.

EDISON Bell Double Spring Gramophone Motors, complete with turn-table and all fittings, a really sound job; 15/-.

SPECIAL Offer of Wire Wound Resistances, 4 watts, any value up to 50,000 ohms, 1/-; 8 watts, any value up to 15,000 ohms, 1/6; 15 watts, any value up to 50,000 ohms, 2/-; 25 watts, any value up to 50,000 ohms, 2/6.

WIRE Wound Potentiometers, 15,000 ohms, 1/6; 50,000 ohms, 2/-; 500,000 ohms, 3/-; 1,000 ohm wire wound semi variable resistances, carry 150 m.a., 2/-.

CENTRALAB Potentiometers, 50,000, 250,000, 1/2 meg. any value, 2/-; 200 ohms, wire wound, 1/-.

POLAR Star, manufacturers' model, 3-gang condensers, fully screened, 7/6; with trimmers.

ORMOND All-brass 0.0005 Condensers, with knob dial, 2/-; with slow motion drive, 3/-.

AMERICAN Triple Gang 0.0005 Condensers, with trimmers, 4/11; Utility Bakelite 2-gang 0.0005 screened with unknob trimmer, 3/6; Polar Bakelite condensers, complete with knob, 0.00015, 0.00035, 0.0003, 0.0005, 1/-.

ORMOND Condensers, 0.0005 2-gang semi shielded, 2/6; brass vanes, with trimmers, 3/6.

MAGNAVOX D.C.152, 2,500 ohms, 17/6; D.C.154, 2,500 ohms, 12/6; D.C.152 Magna, 2,500 ohms, 37/6, all complete with humbucking coils; please state whether power or Pentode required; A.C. conversion kit for above types, 10/-; Magnavox P.M. 7in. cone, 18/6.

RELIABLE Canned Coils with Circuit, accurately matched, dual-range, 3/- per coil; ditto, iron cored, 3/6.

RELIABLE Interval Transformers, 2/-; multi ratio output transformers, 4/6; Amplion L.S. Units, 1/6.

WESTERN ELECTRIC Condensers, 250v. working, 1 ml., 6d.; 2 ml., 1/-; 4 ml., 2/-; 400v. working, 1 ml., 1/-; 2 ml., 1/6.

TC.C. Electrolytic Condensers, 550v. working, 650v. peak, 8 ml., 4/-; 4 ml. or 8 ml., 440v. working, 3/-; 15 ml. 50v. working, 1/-; 25v. working, 25 ml., 1/3; 6 ml. 50v. working and 2 ml. 100v. working, 6d.

TC.C. Condensers, 250v. working, 2 ml., 1/9; 2 ml. 1,500v. working, 6/-; 4 ml. 1,500v. working, 10/-.

HM.V. Condensers, 400v. working, 4x4x1x1x1x1x0.1 or 0.1x0.1x0.1, 4/9; 4x2x1x1x1x0.5, 3/9.

VARLEY Constant Square Peak Coils, band pass type BP.7, brand new in maker's carton with instructions and diagram, 2/6.

VARLEY H.F. Interval Coils BP.8, band pass, complete with instructions in original cartons, 2/6.

SCREENED H.F. Chokes by One of the Largest Manufacturers in the Country; 1/9.

PREMIER British-made Meters, moving iron, flush mounting, accurate, 0-10, 0-15, 0-100, 0-250 m.a., 0-1, 0-5 amps., all at 6/-.

ALARGE Selection of Pedestal Table and Radiogram cabinets, by best manufacturers, at a fraction of original cost, for callers.

THE Following Lines 6d. each, or 5/- per dozen.—Chassis valve holders, 5, 6-, or 7-pin, screened screen grid leads; any value 1-watt wire end resistances, wire end condensers, 0.0001 to 0.1 trimming condensers, Bulgin 3-amp. mains switches.

PLEASE Send for Fully Illustrated Catalogue.

PREMIER SUPPLY STORES, 20, High St., Clapham, S.W.4. Telephone: Macaulay 2188. Nearest Station, Clapham North Underground. 16010

WOBURN RADIO Offer Following New Purchase:—

WESTERN Electric Microphones, brand new and boxed, listed at 18/6 each, super sensitive, 2/6 each; transformer, ratio 85:1, for use with same, 2/3.

WR.C. Eliminators, four models: 150v. output at 30 m.a., D.C. model, 9/9; Universal, A.C./D.C., 21/-; A.C., 21/-; A.C. with trickle charger (2v. 1/2 amp.), 32/6; all types 3 positive H.T. tappings; all guaranteed 12 months.

TRADE Enquiries Invited; new list now ready.

WOBURN RADIO Co., 9, Sandland St., W.C.1. Holborn 7289. [6132]

Components, Etc., for Sale.—Contd.

SOUTHERN RADIO'S Bargains.—Set manufacturer's guaranteed surplus. VARIABLE Condensers.—Lotus 3-gang 0.0005, 12/6; Lotus 2-gang, 0.0005, 8/6; Lotus Dyblock single, 0.0005, 4/9 (list 9/6); all these condensers are complete with dials, escutcheons, knobs, fully screened with trimmers, and boxed; Hydra block condensers, 16 mfd. (2+2+2+1+1), 1.000v. D.C., 7/- each; Dubilier 4 mfd. (2+1+1), 1.000v. D.C., 2/9; 4.5 mfd. (2.25+2.25), 1.000v., for mains noise suppression, 3/-; fixed 4 mfd., 2/3; 2 mfd., 1/6; 1 mfd., 1/-; Utility Midget 2-gang variable condensers, 0.0005, with concentric trimmers, 3/5; T.C.C. 0.1-0.1, 1/3 each. SPEAKERS.—Blue Spot permanent magnet, with universal transformer for power, super power, pentode and Class B, 23/- (list 39/6). E.C. Stork Speaker, in cabinet, 19/6 (list £3/15). MICROPHONES.—"Wonder," ready for use on any set; 3/9 each. BLUE Spot Genuine 100U Inductor Speaker on Chassis; 13/6 (list 39/6). S.T.400 Kits, all specified proprietary components; £2/19/6 (list £4/17/6). EKCO A.C. Eliminators, each new and boxed, in original sealed cartons, type K25, with trickle charger, 25 milliamps, 39/6 (list £5/7/6); type A.C. 25, 33/6 (list £3/17/6); type K.12, with trickle charger, 37/- (list £3/17/6); Ekco trickle chargers type T.C.I., for 2-4- and 6-volt accumulators, 20/- (list 42/-). IGRANIC Superhet Coils, set of 4 (1 Osc., 2 I.F., with pig tails, 1 L.F. plain); 12/6 (list 50/-). LISSEN Superhet 3 Coils Kit, screened, ganged on base with wave change and filament switches; type L.N.5181, for battery or mains; 12/6 (list 30/-). VARLEY Constant Square Peak Coils, complete with all accessories, new, boxed, B.P.5; 2/4. VARLEY H.F. Inter-valve Coils B.P.6, 2/3. FRAME Aerials.—Lewcos dual wave superhet., 9/- each (list 27/6). PICK-UPS.—Marconi No. 19 (1934), 22/6 each (list 32/6); Celestion latest improved type W8 (1934), 16/9 (list 35/-); all new and boxed. READY Radio Instantam Transformers, for matching any valve to speaker; Junior model, ratios 1:2, 1:1, 1 1/2:1, 2:1, 3:1, 7/6 (list 27/6); Senior model, ratios 10:1, 1 1/2:1, 14:1, 16:1, 20:1, 25:1, 12/6 (list 37/6). RECEIVERS.—3-valve screen-grid Elector Super, complete with valves, Exide batteries and accumulator, Celestion moving coil speaker, contained in magnificent walnut cabinet; £3/10 (list £10). OSRAM Thirty-Tree Music Magnet, complete with G.E.C. speaker, two Osram screen-grid and Osram power valves in moulded bakelite walnut cabinet; £3/12/6 (list £9/9); in original sealed cases. READY Radio Meteor Screen-grid 3-valve Kits, all specified components new in sealed cartons; 25/-, less valves; with 3 Mullard valves 42/6 (list £5/7/6). "A" Kit as Above, complete with magnificent walnut cabinet and Celestion perm. mag. speaker; less valves, £3/5; with 3 Mullard valves, £4/2/6 (list £8/17/6). MAINS Transformers.—Full list of mains transformers and chokes sent free. MISCELLANEOUS.—Rotorohm volume controls, all values, 3/- each, with switch, 3/3 (list 10/6); Westinghouse metal rectifiers, H.T. 6, 7, 8, 9/3 each; Ferranti chokes, 20 henry 60 m.a., 6/9 each; Lewcos superhet. 8-way bases, complete with valve holders, grid leak, fixed condenser type "48," 2/- each; Lissen base turntables, 1/6 (list 5/-); Lissen H.F. chokes, 1/6 (list 5/-); Lewcos coils, B.P.F.R. 4/-; T.B.F./C., 3/3; O.S.C. 126 (Extension), 3/3; T.O.S.R., 3/3. ALL Goods Guaranteed and Sent Carriage Paid; hundreds of other bargains in stock. BRANCHES at 271-275, High Rd., Willesden Green, N.W.10, and at 45, Lisle St., W.C.2. Please send all post orders to 323, Euston Rd., N.W.1. SOUTHERN RADIO, 323, Euston Rd., London, N.W.1 (near Warren St., Tube). Phone: Museum 6324. [6168] MAINS RADIO DEVELOPMENT COMPANY Offer Following Guaranteed Surplus:— BROWN'S L.F. Transformers, 3-1, 4-1, 5-1, brand new, 2/9; Bulgin toggles, on-off, 6d. SATOR 0.0001, 0.0003 tubular condensers, 2 meg. resistors, all wire ends, new, any choice; 1/- per 6. T.C.C. 0.1x0.1 mfd. Condensers, 450v. working, 10d.; Mikado 0.002, 0.0005 mfd. condensers, 9d. per 12. PLESSEY 5-pir. V-holders, 1/- per 6; bargain list free; trade supplied. MAINS RADIO DEVELOPMENT COMPANY, 4-6, Muswell Hill Rd., N.6 London. Tudor 4046. [6152] SERADEX Resistors, specified for universal Single Span receiver, etc.; new illustrated list available. TYPE M-150 1 1/2 watts, made in values up to 100,000 ohms, 8d. TYPE G.L. Wire-end Grid Leak, made in values 0.1, 0.15, 0.25, 0.5, 1.0, 2.0, 3.0 and 5.0 megs., 5d. each; also available in cap-end type at same price. SERADEX 275 Meters, flush mounting terminals, bakelite cased, 2 3/4 in. dial, reads A.C. or D.C.; prices from 6/- each. SERADEX P.M. Speaker, with heavy cobalt steel magnet, 9 ratio transformer, matching every modern valve, made to sell at 52/6; price 32/6; each delivery ex stock; attractive trade terms. SEND for New Bargains List, giving details of hundreds of bargains. TREVOR PEPPER, 575, Moseley Rd., Birmingham, 12. Telephone: Calthorpe 1618. [6171] THE Following Unused Set Manufacturers' Surplus, all goods guaranteed perfect; immediate delivery. TRANSFORMERS, 350-0-350v., 75 m.a., 4v. 4a. 4v. 2a., 12/6; A.C. and D.C. elim. transformers, first class make, tappings S.G., detector, and power (150v., 25 m.a.) A.C. type, with Westinghouse rectifier, 25/-; D.C. type, 12/6. DUBILIER Resistors, 1 watt type, 7d.; 2 watt type, 1/2; 3 watt type, 1/9; Dubilier or T.C.C. condensers, 8 mfd. or 4 mfd., 500v. working, 50v. 50 mfd., 200 mfd., 10v., 3/6; Mansbridge type, 4 mfd. 400v., 4/-; 4 mfd. 750 v., 6/6. MARCONI K19 Pickups, 22/6; B.T.H. pickup tone arms, 3/-; B.T.H. needle armature pickups, 29/-. COLVERDYNES, 7/6; Clix 5-pin valve holders, 5d.; Rotorohm volume controls, with switch, 2/6. WESTINGHOUSE Rectifiers, H.T.8, 9/6; H.T.9, H.T.10, H.T.11, L.P.5, 10/9; transformers (Regentone) for H.T.8 or H.T.9, with 4v. 4a. L.T., 7/-; carriage paid, cash with order or c.o.d.; send for list. WARD, 45, Farringdon St., London, E.C.4. Phone: Holborn 9703. [6165]

Components, Etc., for Sale.—Contd.

BIRMINGHAM RADIOMART Revised List Now Ready; more components than advised in whole these columns; stamp essential. RADIOMART.—Utility fully screened 3-gang, with trimmers, list 22/-, almost identical Radiophone; 6/6. RADIOMART.—Igranic smoothing chokes, 20-10ohy., 260 ohms, 100 m.a., Stalloy core impregnated interleaved windings; 2/9. RADIOMART.—Single span formers, 1in.x2in., 7 for 10d.; 100 m-mfd. micros., 1/3. RADIOMART.—Radiophone straight line dials, illuminated, ours have oxidised escutcheons, knob; 3/6. RADIOMART.—Igranic boxed nickelcore 5-1, 5-1 R transformers, list 10/6, 3/11; Igranic 8/6 parallel feed, 2/11. RADIOMART.—Centralab 1-watt colour coded resistances, nearly all values; 6d. RADIOMART.—Radiophone wire-wound logarithmic potentiometers, 5,000, 2/-; 15,000, with concentric independent main switch, 2/9. RADIOMART.—New Metvick 110-volt "A" transformers, sold for laminations and clamps, 3/6. RADIOMART.—Screened Caradio ignition cable, ideal screened downlead; list 4/6, 9d. yard. RADIOMART.—3 3/4 in. flush £3 moving coil milliammeters, 10, 25, 50, 100 m.a.; 16/6. RADIOMART.—Visual tuning meters, extremely neat, 5/9; 30 ohm potentiometer for humdimming, 8d. RADIOMART.—Sovereign 50,000 genuine wirewound potentiometers, 5-watt, 2/-; Electrad 50,000 potentiometers, 1/6. RADIOMART.—Boxed Telsen, 500v. electrolytics, 6 mfd., 2/9; 4 mfd., 2/7; 275v. 6 mfd., 2/-; Dubilier 4 mfd. 200v., 1/3; all dry. RADIOMART.—T.C.C. 250v. A.C., equivalent 400v. D.C. working, 4x4x4 (12 mfd.), 3/9; T.C.C. 8 mfd. electrolytics, 3/-. RADIOMART.—Aerovox 8x8 mfd. dry, the world's best electrolytic; 3/6; cheapest smoothing possible. RADIOMART.—Non-inductive wire-ended tubulars, 1,500v., 0.1, 0.01, 0.02, 6d.; Philips ditto, 0.0001, 0.001, 2d. RADIOMART.—Igranic Igranicore chassismount dual range coils, 3/6; Igranic 400 ohms potentiometers, 6d. RADIOMART.—Utility 1934 bakelite tuning and reaction condensers, 0.0005, 10d.; 0.0003, 8d.; 0.0002, 0.0001, 6d.; 0.0003 differentials, 1/6. RADIOMART.—Cadmium 5-valve chassis, 1/6; 4-valve chassis, 1/-; postage 6d. extra. RADIOMART.—Utility W312B screened 2-gang 0.0005 super bakelite, fitted Uniknob trimming disc drive; 2/11. RADIOMART.—Telsen boxed differential condenser with knob, 0.0001, 0.00015, 1/-; 0.0003, 0.00035, 1/3. RADIOMART.—Met-Vic boxed H.F. chokes, really efficient. Utility snap switches, 9d. RADIOMART.—Colvers 5-watt wirewound potentiometers, 2,500, 15,000, 1/6; Magnum, 25,000, 1/9. RADIOMART.—(G5NI), shortwave specialists; actually stock Hammarlund "Comet Pros," McMurdo single signal, National F.B.7. RADIOMART.—Igranic ironcore dualrange shortwave coils, 3/3; with switch; 479; Raymart shortwave H.F.C., 9d. RADIOMART.—Famous 0.0001 all brass shortwave variables, 1/9; Ormond 0.00025 Ioloss pitgail, 1/9. RADIOMART.—Western Electric solidback guinea microphones, 2/9; Beehive standoff insulators, 8d.; Frequentist valve holders, 9d. RADIOMART.—Orders over 6/- post free.—The Square Dealers, 19, John Bright St., Birmingham. [6169] PEARL & PEARL, 190, Bishopsgate, London, E.C.2. All the following bargains guaranteed new goods. Cash or C.O.D. Carriage paid. DONT Miss These Wonderful Bargains. EKCO 1934 A.C. Eliminators, Model A.C.25, 25 m.a. output, input 200/250 volts, 40/100 cycles, variable S.G. tapping; variable 50/80 volt tapping; 120/150 volt tapping; list price £3/17/6; our price 35/-. MODEL K.25 as A.C. 25, but includes in addition an L.T. charger for 2-4-6-volt accumulators; list price £5/7/6; our price 45/-. TRIOTRON 4-pole Balanced Armature Speaker Units, type "B," sensitive, beautiful tone; list 22/6; our price 6/11. POLAR 2-gang Screened Condensers, with trimmers, pilot lamp holder, calibrated scale and escutcheon; list 27/6; our price 8/11. LISSEN Pickups with Volume Control Incorporated; list 15/-; our price 6/11. LISSEN Drum Dials, hair line tuning, fit all condensers, illuminated dials; our price 4/6. SOVEREIGN Iron Cored Coils, with circuits, 2/11 each. 200 ONLY.—Marconiphone 2 valve receivers with speaker and Marconi valves, in handsome oak cabinet; 28/11 carriage forward. ALL Mail Orders Direct to Pearl & Pearl, 190, Bishopsgate, London, E.C.2. Telephone: Bishopsgate 1212 (3 lines). [6142] VAUXHALL.—All components advertised last week are still obtainable from Vauxhall Utilities, 163a, Strand, W.C.2. Phone: Temple Bar 9338. [6167] EXPERIMENTER'S Surplus.—Ferranti A.F.5, 15/-; B2, 10/6; Weston milliammeter, type F, 0-50, 17/6; Blue Spot 88 pick-up, 20/-; Langham portable, less valves and batteries, 20/-; Primustatic speaker, 21/-.—Blyth, South Close, Pinner. Pinner 1403. [6151] £8.—Amplifier, A.C.H.L. transformer, coupled D, 0.25s. push-pull self-contained speaker, leaflet, parts microphone amplifier, including H.F. Pentode, Mullards circuit, £1; brand new P.M. speaker unit and exponential horn, complete, £5; unit itself costs £6/6.—Bradford, Entertainer, Whitechurch, Bristol. [6141] PIONEER RADIO Offers Ericsson 5-1 L.F. Trans-formers, list price 17/6, new and guaranteed; our price 2/3, post free U.K.; Varley Constant Square Peak Band-Pass Coils, type B.P.5, complete with switch, brand new, in maker's original carton, with full instructions and diagrams, list price 15/-, our price 2/4, post free U.K.; Polar 3-gang Star Minor Condenser with trimmer, brand new, list price 18/9, our price 7/- each, post free U.K.; Collaro Electric Gramo. Motor, A.C., 200-250, with pick-up and volume control, auto start and stop, brand new, listed at £4, our price 47/6, carriage paid; Celestion Energised M.C. Speaker, 2,500 ohms, model D.C. 2054, with universal transformer, list price £2/5, our price 12/6; bankrupt set manufacturers' stock. PIONEER RADIO, Coptic St., London, W.C.1. Museum 9606. [61425]

Components, Etc., for Sale.—Contd.

CINEMA Speaker (Large A.C. Model), 35/-; R.K. speaker (D.C.), with transformer, 19/6; Varley Ni-Core coils (4-gang) and Cyldon condenser, 38/6; Ferrocart 4-gang and Radiophone condenser, unused, 45/-; dials, 3/-; Ferranti 300 V. voltmeter (1,000 W. type), 39/6.—Little, 12, Sandhill Gardens, Belfast. [6161] MOVING Coil Meters.—10-50-100 milliamps, 6in., £1; 15-150 milliamp, 8in., new, £1; 10 milliamps, 4in., 10/-; 5 milliamps, 2 1/2 in., 7/6; 15 amps., 2 1/2 in., 5/-; 6 and 120 volts, 7/6; converter and transformer, 220-240 D.C. to 100, 150, 230 A.C., £2; 1.5 kva. transformer, 150-240 A.C., 2,000 V., secondary, £1/10; Wheatstone bridge, 7/6; Coolidge tube, £1.—Gibbins, 19, Montrose Av., Sidcup. [6173] MISCELLANEOUS. EVERYTHING for Movies.—Cameras and Projectors from 20/-; screens from 5/-. ILLUSTRATED ENTERPRISES, 159, Wardour St., London, W.1 (facing Film House, Oxford St. end); not a shop, but a warehouse packed with motion-picture equipment; your inspection invited. Phone: 6889 Gerrard; free parking facilities. [5936] GUARANTEED Expert Repairs to Any Receiver, estimate free, highest quality workmanship, lowest prices; receivers taken in part exchange.—Zenith Radio Service, 17, Park St., Gulltord. Phone: 1700. [61423] AMBITIOUS Men.—Qualify for a well paid post by studying at home with the T.I.G.B. Write to-day for "The Engineer's Guide to Success," 152 pages, free, which contains the widest selection of engineering and wireless courses in the world and shows you how to become A.M.I.E.E., A.M.I.Mech.E., A.Rad.A., etc. State branch, post or qualification that interests you.—The Technological Institute of Great Britain, 82, Temple Bar House, London, E.C.4. (Founded 1917. 19,000 successes.) [6029] PATENT AND TRADE MARK AGENTS. A. MATHISEN, Chartered Patent Agent; patents, designs and trade marks.—First Avenue House, High Holborn, London, W.C.1. Holborn 8950. [5284] CEE and Co. (H. T. P. Gee, Patent Agent for Great Britain, U.S.A., Canada, etc., Mem. R.S.G.B. A.M.I.E.E.) 51-52, Chancery Lane, London, W.C.2 (2 doors from Government Patent Office). Phone: Holborn 1525. Handbook free. [6001] REPAIRS AND SERVICE. METROPOLITAN RADIO SERVICE Co. for Guaranteed Repairs to American (Midget and Standard) Receivers. CLARION Service Depot; replacement parts; transformers rewound; terms to the trade.—1021, Finchley Rd., Golders Green, N.W.11. Speedwell 3000. [60435] MAINS Transformers Rewound; prompt service; satisfaction guaranteed; prices on request.—The Starbury Electric Co., Wesley Terrace, Dipton, Newcastle-on-Tyne. [61556] PALMERSTON RADIO SERVICES for All British and American Radio Repairs and Supplies, London and Home Counties.—Palmerston Rd., N.W.6. Maida Vale 6758. [61554] REDUCED Terms During Summer; service on all British and American wireless apparatus; special chassis construction to specification; guaranteed workmanship only.—The Master Radio and Electrical Co., Ltd., 102-5, Shoe Lane, E.C.4. [6179] OLD Sets Transformed to All Mains Universal A.C.-D.C. with New High Voltage Valves, powerful, clear, hum-free reception guaranteed; prices 10/- per socket, plus price of valves; no extra parts charged for.—Sablou's Radio, 69, Sister's Ave., London, S.W.11. [5837] REPAIRS to Moving Coil Speakers, cones and coils fitted or rewound, Eliminators and transformers quoted for. Loudspeakers, H.I. and speech transformers, 4/- each. Post free. Trade invited. Satisfaction guaranteed. Prompt service.—Loud-speaker Repair Works, 5, Balham Grove, London, S.W.12. Battersea 1321. [6394] ELECTRIC CLOCKS. SPECIAL Offer.—Superior A.C. main electric clock movements, 200-250v. 50 cycles, drive up to 10-inch hands; 16/6, post 6d.—Write details, Ebury Bridge Radio Co., 35, Ebury Bridge Rd. Sloane 8407. [5963] EXCHANGE. DEAL With the Firm that Gives You the Highest Possible Allowance in Exchange, sets or components; prompt attention and deliveries.—Mildmay Radio Exchange, Phone Clissold 5001, 24, Mildmay Grove, London, N.1. [5985] EXTENDED PAYMENTS. EASY PAYMENTS.—We supply you direct, by easy payments, components, accessories, and sets, any make; 10% down, balance spread over 11 months; any radio goods ordered c.o.d. despatched same day.—Send list of requirements to London Radio Supply Co. (established 1925), 11, Oat Lane, London, E.C.2. [6337] FINANCIAL PARTNERSHIPS. OLD-ESTABLISHED Radio Business has Vacancies for a Salesman and a Director, with investment.—Box 1071, c/o The Wireless World. [6174] AGENCIES WANTED. WHOLESALE Agencies Required for Irish Free State for Sets, parts, electrical, also manufacturers' surplus.—BM/NJEC, London, W.C.1. [6148] WANTED. ELIMINATOR, about 150v. 30 m.a., cheap.—67, Windsor Rd., Evesham. [6160] WANTED, all mains short wave superhet.—Write Laker, 6, Southend Rd., Beckenham. [6175] SPOT Cash for New or Used Modern Components.—S Economic Radio Co., 96-98, South Lambeth Rd., S.W.8. [5964] HIGH-CLASS Radio Parts and Sets Wanted for Cash, new or second-hand, any quantity, we pay up to one-third of the retail value for class goods; send yours, stating reasonable price; cash by return (no junk, please); dealers' obsolete stocks also purchased, any amount; van and representative will call for any reasonable lots.—Mildmay Radio Exchange, 24, Mildmay Grove, London, N.1. Phone: Clissold 5001. [5984] SITUATIONS VACANT. YOUTHS Trained for all branches wireless profession. Britain's leading college. Training fee payable after appointment. Students boarded. London representative for interviews. Prospectus free.—Wireless College, Colwyn Bay. [6388]

A New

PARMEKO

Product

The "PARMEKO" JUNIOR Microphone

It is of interest to note that Messrs. Partridge & Mee Ltd. have now introduced a quality microphone at a reasonable price. Considerable research and special methods of construction have made this possible. The microphone has a good response and compares very favourably with the highest priced carbon microphone.

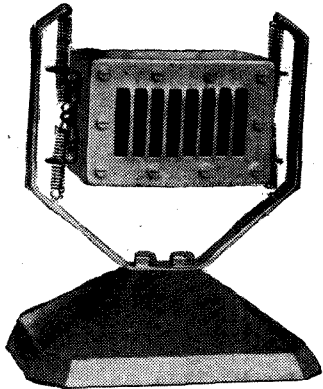

Finished in grey cellulose with all bright parts heavily chromium plated.

Supplied complete with Table Stand.

PRICE

£3-0-0

Suitable transformer
12s. 6d.

PARTRIDGE & MEE LTD.
"PARMEKO" WORKS,
AYLESTONE PARK, LEICESTER.
and at 74, New Oxford Street, London, W.C.

METAL RECTIFICATION
Again preferred

When an A.C. Mains job has to be reliable the designer's first thought is the rectifier ...and his invariable choice is a Westinghouse Metal Rectifier. 60,000 hours non-stop. Continuous testing at full load, and no falling-off in output. No wonder Westinghouse is specified again and again.



METAL RECTIFIERS
for the Audio-Frequency
TEST OSCILLATOR

The Westinghouse Brake & Saxby Signal Co., Ltd.,
82, York Road, King's Cross, London, N.1.

REFINEMENTS
WHICH ARE OUTSTANDING
IN THE DESIGN AND
MANUFACTURE
OF -

Darwin

PERMANENT
MAGNETS
FOR MOVING
COIL SPEAKERS

No. 5
ENCLOSED POT
TYPE

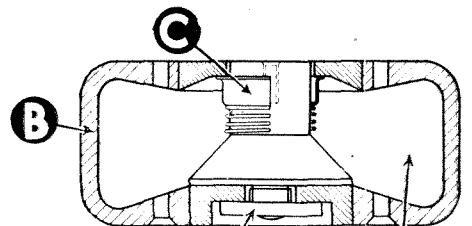

A Uniform distribution of flux in air-gap.

B Uniform distribution of magnet steel ensuring efficient hardening.

C Patent dust cover to prevent entry of foreign matter to air-gap.

D Patent fixing of centre pole ensuring mechanical accuracy of air-gap.

E Completely enclosed pot forms attractive and clean design.

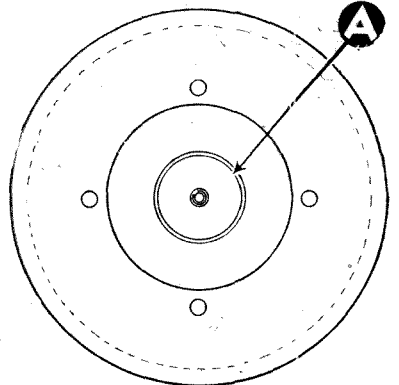

These details are given in order that manufacturers and designers of Speakers and Radio Receivers may be aware of the refinements which are essential features in the design and manufacture of Darwin Magnets. Each month a different type of Magnet will be illustrated.

Our Technical Staff is always available to assist in solving any magnet problem, and can materially assist in economies in magnet steel for a given output and performance.

Darwins Ltd
CORRECT MAGNET DESIGN

Head Office: Fitzwilliam Works, SHEFFIELD.
London Office: 29/31, Regent St., S.W.1.

NOW ON SALE!

RADIO RECEIVER MEASUREMENTS

By Roy M. Barnard, B.Sc., A.M.R.E.

Although primarily designed for the benefit of the radio service engineer, this concise handbook is also of practical value to the amateur experimenter.

It describes the methods of measuring receiver performance and provides provisional standards as a basis for judging performance. Measurements of sensitivity, selectivity and fidelity are explained at length and the interpretation in estimating receiver performance is carefully set out.

Details are given of up-to-date methods of receiver testing with full descriptions of commercial signal generators and their application to the adjustment of modern superheterodynes and "straight" receivers.

Complete with fifty-three illustrations and diagrams, summaries of method, four appendices and a general index.

PRICE 4/6 net By post 4/9

From all booksellers or direct from the Publishers

ILIFFE & SONS LTD., DORSET HOUSE, STAMFORD STREET, LONDON, S.E.1
W.W. 10.

The First Aero Weekly in the World

"FLIGHT" is the recognised leading authority on aviation. Sections are devoted to:

Private Flying, Work of the Clubs and Schools, Commercial Aviation, Airlines and Airports, Royal Air Force news, The Work of R.A.F. squadrons.

A special staff of highly competent aerial photographers ensures that "Flight" contains the finest photographs of aviation in all its aspects.

Illustrated descriptions of new aircraft, aero engines and equipment, British and Foreign, appear regularly, as well as helpful articles giving the latest information for Club members and amateur pilots.

"Flight" is the official organ of the Royal Aero Club of the United Kingdom.



EVERY THURSDAY
6d.

From all Newsagents and Bookstalls

Subscription

British Isles	-	-	-	33/-
Other Countries	-	-	-	35/-

FLIGHT

The AIRCRAFT ENGINEER AND AIRSHIPS

FLIGHT PUBLISHING CO. LTD., DORSET HOUSE, STAMFORD ST., LONDON, S.E.1
W.W. 10.